



Tools



French manufacturer
since 1964

Celebrating

50

years of innovation

1964 - 2024

Collision Repair

2024**B**



SPOT WELDING - DENT PULLER - MIG-MAG/GMAW-FCAW - PLASMA CUTTING -
INDUCTION - RIVETING - LIFT - BODYSHOP TOOLS

A solid manufacturing group

900 people € 130 000 000

C1+ Credit Rating Banque de France
55 000 m² 2 factories



INVEST IN THE FUTURE



French manufacturer since 1964

A family company



Nicolas & Bruno Bouygues



Welding, Plasma cutting & Induction heating



Collision repair



Chargers, Boosters & Starters

A worldwide coverage

125 countries



GYS FRANCE Laval

GYS GERMANY Aachen

GYS U.K. Rugby

GYS CHINA Shanghai

GYS ITALIA Venezia

GYS IBERICA Madrid

www.gys.fr



visit with



DENT PULLING

GYS POT	6
GYS POT PRO	7
GYS POT ALU	8
GYS POT COMBI	9
ACCESSORIES & CONSUMABLES	10
GYS POT ARCPULL	12
COMBI ARCPULL	13
ACCESSORIES & CONSUMABLES	16
FAST EASY TOOLS	18
ACCESSORIES LEVELLING BARS	20
COMPLETE WORKSTATIONS	24

PULLING SYSTEMS

AIRFIX DRAW ALIGNER	38
DRAW ALIGNER	40
FRAME STRAIGHTENING	42

PAINTLESS DENT REPAIR

POWERDUCTION AUTO DENT REPAIR	46
GLUE PULLING REPAIR	50

SPOT WELDING

TECHNOLOGY	54
PORTASPOT / GYS POT 32D-X / 100R-CX	56
GYS POT BP GENIUS	58
GYS POT PTI-S7 / PTI PREMIUM PRO	60
GYS POT PTI GENIUS	62
GYS POT PTI NEO	64
GYS POT PTI MASTER / PTI EXPERT	66
G ARMS	68
ACCESSORIES & CONSUMABLES	69
X ARMS / C ARMS	70

RIVETING

GYS PRESS 10T	73
GYS PRESS PREMIUM 10T PP	75
WORKSTATION	76
ADAPTERS	78
DIES BOXES & RIVETS	80
ACCESSORIES	83

MIG WELDING

GYS AUTO	86
E GYS AUTO	88
P GYS AUTO	90
AUTOPULSE	92
TORCHES & CONSUMABLES	96

PLASMA

EASYCUT K	101
EASYCUT	102
CUTTER	103

INDUCTION HEATING

GYS DUCTION	106
COMBI DUCTION	107
POWER DUCTION	108
ACCESSORIES & CONSUMABLES	112

TRUCK TOOLS & MOBILE LIFTS

TROLLEY IW1	115
MULTITOOL TRUCK	115
SPOT LIFT	116
QUICKLIFT / AIR JACKS	118
ERGO LIFT	119
MANUAL DOOR LIFT / MANUAL WHEEL LIFT	120

ACCESSORIES

WELDING HELMETS	122
FUME EXTRACTION	125
WINDSCREEN REPAIR	123
BUMPER REPAIR	128
HAND TOOLS	130
PNEUMATIC TOOLS	134
WORKING LIGHTS	136
SANDING & DUST EXTRACTION	138
WORKING SUPPORTS	140
ELECTRIC VEHICLES	144
SAFETY PROTECTION	146



DENT PULLING

STEEL / ACIER / STAHL

GYSPOT	6
GYSPOT PRO	7

ALU

GYSPOT ALU	8
------------	---

ALU + STEEL / ACIER / STAHL

GYSPOT COMBI	9
ACCESSORIES & CONSUMABLES	10

DRAWN ARC ALU + STEEL / ACIER / STAHL

GYSPOT ARCPULL	12
COMBI ARCPULL	13
ACCESSORIES & CONSUMABLES	16

FAST DENT PULLING	18
-------------------	----

LEVELLING BARS	20
----------------	----

COMPLETE WORKSTATIONS	24
-----------------------	----



GYSPOT

DENT PULLING STEEL ACIER - STAHL

- Stars - Étoiles - Ausbeulstern
- Rings - Anneaux - Zugösen
- Wavy wires - Fils ondulés - Wellendraht
- Impact shrinking - Rabattage d'impact - Glätten

OPTIONS

Consommables - Consumables p.10



Chariots - Trolleys p.24



- Stars - Étoiles - Ausbeulstern
- Rings - Anneaux - Zugösen
- Wavy wires - Fils ondulés - Wellendraht
- Impact shrinking - Rabattage d'impact - Glätten

- Tempering - Rétreinte - Temperieren



FIXED GUN

FIXED GUN

GYSPOT 26.02

2600 A x1 **AUTOMATIC**

230V • 1~

052208

included



Automatic quick gun, 1.8 m, 70 mm²
+ Hammer (057272)

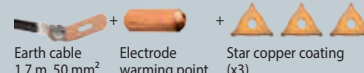

Earth cable 1.7 m, 50 mm² Electrode warming point Star copper coating (x3)

GYSPOT 27.02

2600 A x1 **MANUAL**

230V • 1~

055353

included



Manual quick gun, 1.8 m, 70 mm² (058705)
+ Hammer (057272)

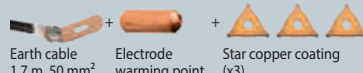

Earth cable 1.7 m, 50 mm² Electrode warming point Star copper coating (x3)

GYSPOT 34.02 & 34.04

3500 A x1 **MANUAL**

230V • 1~

GYSPOT 34.02
065741

400V • 2~

GYSPOT 34.04
067943

included



Manual quick gun, 2 m, 50 mm²
+ Hammer (057272)

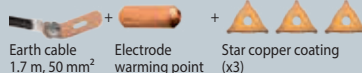

Earth cable 1.7 m, 50 mm² Electrode warming point Star copper coating (x3)

- Stars - Étoiles - Ausbeulstern
- Rings - Anneaux - Zugösen
- Wavy wires - Fils ondulés - Wellendraht
- Impact shrinking - Rabattage d'impact - Glätten
- Tempering - Rétreinte - Temperieren
- Rivets - Rivets - Nieten
- Rings - Rondelles - Unterlegscheiben
- Studs - Goujons - Gewindebolzen

SYNERGIC CONTROL

PATENTS REGISTERED NUMBERS
EUROPEAN TRADEMARK & DESIGN



GUN WITH CONNECTOR

GYSPOT 39.02 & 39.04

3800 A x1 **AUTOMATIC**

230V • 1~

GYSPOT 39.02
052215

400V • 2~

GYSPOT 39.04
052222

included



Automatic quick gun, 2 m, 70 mm² (057517)
+ Hammer (057272)



Earth cable 2 m, 70 mm² SPOTTER BOX STANDARD (053915)
(Details p.10)

GYSPOT PRO 230 & PRO 400

3800 A x2 **AUTOMATIC**

230V • 1~

GYSPOT PRO 230
052178

400V • 2~

GYSPOT PRO 400
052185

included



Automatic quick gun, 3 m, 50 mm² (057500)
+ Hammer (057272)

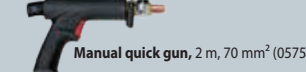

Manual quick gun, 2 m, 70 mm² (057524)



Earth cable 2 m, 70 mm² SPOTTER BOX PRO (050075)
(Details p.10)

GYSPOT EXPERT 200, 230 & 400

3800-4500 A x2 **AUTOMATIC**

230V • 1~

GYSPOT EXPERT 230
066885

200-240V • 1~

GYSPOT EXPERT 200
058842

4350 > 5100 A

400V • 2~

GYSPOT EXPERT 400
058859

4500 A

included



Automatic quick gun, 3 m, 70 mm² (059207)
+ Hammer (057272)

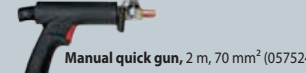

Manual quick gun, 2 m, 70 mm² (057524)

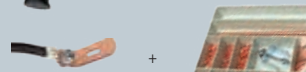

Earth cable Thick 3 mm² 2 m, 70 mm² SPOTTER BOX PRO (050075)
(Details p.10)

QUICK GUNS

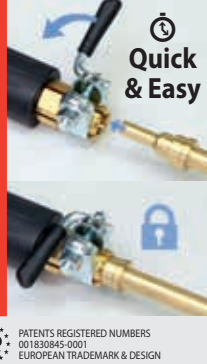

Quick & Easy

AUTOMATIC



WITH CONNECTOR
2 m, Ø 70 mm²
included 39.02/04
057517



WITH CONNECTOR
3 m, Ø 50 mm²
included PRO 230/400
057500

WITH CONNECTOR
3 m, Ø 70 mm²
included EXPERT 200/230/400
059207

MANUAL



WITH CONNECTOR
cable 2 m, Ø 70 mm²
included PRO 230/400,
EXPERT 200/230/400,
COMBI 230EPRO
057524

No connector
cable 1.8 m, Ø 70 mm²
for 27.02
058705

No connector
cable 2 m, Ø 50 mm²
for 34.02/34.04

Mandrels for gun -
Mandrins pour pistolets
- Pistole & Anschlußstücke,
Zubehör



QUICK GUN
057531



D1
048959



Nut - Écrou
053199

Microswitch
053267

	GYS NORM. 62135	50/60 Hz	I ₂ max A	U ₂ V	I _{AM} A	I _{RMS} A	kW	OK	OK	MANUAL	SYNERGIC	AUTOMATIC	MANUAL	SEPARATE CABLE GUN	LxWxH cm / kg
GYSPOT 26.02	230V	2 m	2600	5,4	16	1800	10	OK	—	—	—	—	—	—	40 x 25 x 31 / 18
GYSPOT 27.02	230V	2 m	2600	5,4	16	1800	10	OK	—	—	—	—	—	—	40 x 25 x 31 / 18
GYSPOT 34.02	230V	2 m	3500	7,4	16	2500	20	OK	OK	—	—	—	—	—	42 x 36 x 31 / 23.9
GYSPOT 34.04	400V, 2ph	4 m	3500	7,4	16	2500	20	OK	OK	—	—	—	—	—	42 x 36 x 31 / 24
GYSPOT 39.02	230V	4 m	3800	7,4	16	2800	20	OK	OK	—	—	—	—	—	49 x 38 x 29 / 27.5
GYSPOT 39.04	400V, 2ph	4 m	3800	7,4	16	2800	20	OK	OK	—	—	—	—	—	49 x 38 x 29 / 25.2
GYSPOT PRO 230	230V	8 m	3800	7,4	16	2800	20	OK	OK	—	—	—	—	—	49 x 38 x 29 / 29.6
GYSPOT PRO 400	400V, 2ph	8 m	3800	7,4	16	2800	20	OK	OK	—	—	—	—	—	49 x 38 x 29 / 29.4
GYSPOT EXPERT 200	200-240V	8 m	4350 > 5100	7,2-8,7	30(D)	3100 > 3600	25 > 36	OK	OK	—	—	—	—	—	49 x 38 x 29 / 34.6
GYSPOT EXPERT 230	230V	8 m	3800	7,4	16	2800	20	OK	OK	—	—	—	—	—	49 x 37 x 31 / 30.6
GYSPOT EXPERT 400	400V, 2ph	8 m	4500	7,4	16(D)	3200	25	OK	OK	—	—	—	—	—	49 x 38 x 29 / 32.9

GYSPOT

STEEL DENT PULLING



GYS POT ALU

DENT PULLING ALU



SYNERGIC CONTROL

PATENTS REGISTERED NUMBERS
EUROPEAN TRADEMARK & DESIGN



Goujons - Studs



GYS POT COMBI

DENT PULLING ALU+STEEL ACIER - STAHL

PATENTS REGISTERED NUMBERS
EUROPEAN TRADEMARK & DESIGN

Steel / Acier / Stahl

Alu



- Stars - Étoiles
- Rings - Anneaux
- Wavy wires - Fils ondulés
- Impact shrinking - Rabattage d'impact
- Tempering - Rétreinte
- Rivets - Rivets
- Rings - Rondelles
- Studs - Goujons

NEW



FIXED GUN

GYS POT ALU 66

13000 A x1 AUTOMATIC

230V • 1~

080188

included for $\varnothing 4$ mm



AD ANTI-DUST

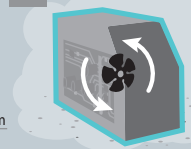

GYS POT ALU PRO FV

13000 A x1 AUTOMATIC

110 > 230V • 1~

021990

included for $\varnothing 4$ mm



FV FLEXIBLE VOLTAGE

85 V ← 265 V

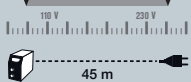

ALU GUN

AUTOMATIC



3 m, $\varnothing 25$ mm²

included SPOT ALU FV & COMBISLOT 230

054066

(x 3)
065635

66 mF CAPACITOR DISCHARGE WELDING

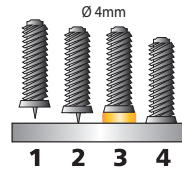

Joint rings for mandrel $\varnothing 4/5/6$ x 2
060814

OPTIONS

Consumables - Consommables p.11



ALU accessories - Accessoires ALU p.19



Trolleys - Chariots p.24



PATENTS REGISTERED NUMBERS
002446450-0001
EUROPEAN TRADEMARK & DESIGN

2 GUNS INCLUDED



GUN WITH CONNECTOR

GYS POT COMBI 230 E.PRO

3800 A Acier / Steel / Stahl

13000 A Alu

230V • 1~

x2 AUTOMATIC MANUAL AUTOMATIC

021266

included

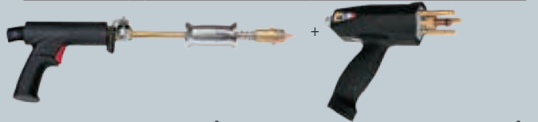

Manual quick gun, 2 m, 70 mm² (057524) + Hammer (057272)

Automatic alu gun, 3 m, 25 mm²



Earth cable 2 m, 70 mm²

SPOTTER BOX PRO (050075) (Details p.10)

ALU BOX STANDARD (050020) (Details p.11)

	CE 62135	50/60 Hz	I ₂ max A	U ₂ V	I _{AM} RMS A	kW	OK	MANUAL	SYNERGIC	AUTOMATIC	MANUAL	SEPARATE CABLE GUN	3 m	Included Alu box	LxWxH cm / kg					
MADE IN GYS CHINA	GYS POT ALU 66	230V	6 m	13 000	50 > 200	5	—	0.52	OK	OK	■	■	—	■	x1	—	—	3 m	Included Alu box	27 x 20.5 x 27 / 13.5
MADE IN FRANCE	GYS POT ALU PRO FV	110 > 230V	6 m	13 000	50 > 200	5	—	0.65	OK	OK	■	■	—	■	x1	—	—	3 m	Included Alu box	49 x 38 x 29 / 13.4
	GYS POT COMBI 230 E.PRO	230V	8 m	3800 (steel) 13000 (alu)	7,4 (steel) 50 > 200 (alu)	16	2800 (steel)	20	OK	OK	—	■	■	■	x1	x1	■	2/3 m	Included Spotter box + Alu box	54 x 76 x 34 / 47.5

GYSPOT

ALU + STEEL DENT PULLING



DENT PULLING DRAWN ARC ALU + STEEL

ACIER - STAHL



MANUAL

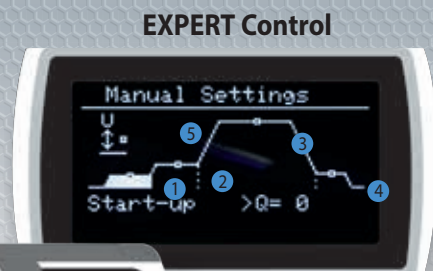

- Rings - Anneaux - Zugösen
- Studs - Goujons - Gewindebolzen
- Stainless steel nails - Tiges inox - Edelstahlnägel



- Start-up - Amorce - Zündung
- Scouring (I & t) - Décapage - Abbeizen
- Arc (I & t) - Arc - Lichtbogen
- Hitching (I & t) - Accroche - Verklebung
- Height - Hauteur - Höhe

7 languages
FR, EN, DE, SP, IT, NL & RU

SYNERGIC DIGITAL GUNS

★★★★★
UNIQUE Linear Motor

DRAWN ARC PROCESS
Gas protection

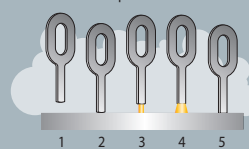

3 m, Ø 25 mm²
included
ARCPULL 200 & 350,
COMBI ARCPULL



Full control



Consumables for Gun



FV FLEXIBLE VOLTAGE

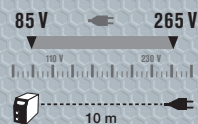

SR SECONDARY REGULATION

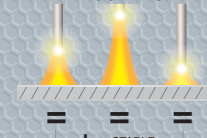

AD ANTI-DUST

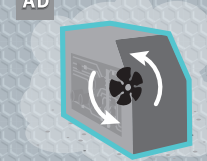

MANUAL & SYNERGIC CONTROL

2 GUNS INCLUDED



Ø max
Alu : 6 mm
Fe : 6 mm



GUN WITH CONNECTOR

GYSPOT ARCPULL 200 CAR BODY REPAIR

100 · 230V · 1~
200 A **T x1 MANUAL**
FV SR AD
057470
included

- Manual synergic gun 3 m, 25 mm² (AluSpec + AIMg3 + AIMgSi) 059429
- ALU RING BOX 1.5 mm (AluSpec + AIMg3 + AIMgSi) 059429
- Lifting rod 180 mm (x1) 082915

OPTIONS details p.24
Weld 810 for ARCPULL 200 037489

GYSPOT COMBI ARCPULL

230V · 1~
ARCPULL 200 A + **EXPERT 3800 A**
Alu Acier / Steel / Stahl
T x1 MANUAL + **T x1 MANUAL**

- 069824
Arccpull accessories included
- Manual synergic gun 3 m, 25 mm² (AluSpec + AIMg3 + AIMgSi) 059429
 - ALU RING BOX 1.5 mm (AluSpec + AIMg3 + AIMgSi) 059429
 - Lifting rod 180 mm (x1) 082915

- Expert accessories included
- Manual quick gun, 2 m, 70 mm² (057524) + Hammer (057272)
 - Earth cable 2 m, 70 mm²
 - SPOTTER BOX PRO (050075) (Details p.10)

MADE IN FRANCE 60974-1	50/60 Hz	I ₂ A	SYNERGIC	MANUAL	IRMS (A)	GUN		U ₂ V	AM A	kW	OK	OK	LxWxH cm / kg
						Acier/Steel	Alu						
GYSPOT ARCPULL 200 CAR BODY REPAIR	110 · 230V	6 m	10 · 100 (110 V) 10 · 200 (230 V)	■	■	—	Manual + Digital Gun Motion Control	20.4 · 24 V (110 V) 20.4 · 28 V (230 V)	16	2.4 (110 V) 5.6 (230 V)	OK	OK	49 x 37 x 30 / 14.5
GYSPOT COMBI ARCPULL	230V	8 m	Alu 10 · 200 Acier 3800	■	■	Steel 3800	Manual Automatic (not included)	Alu 20.4 · 28 V Steel 7.4 V	16	Alu 5.6 Steel 20	OK	OK	72 x 42 x 29 / 41.5



GYS POT ARCPULL

DENT PULLING DRAWN ARC ALU + STEEL ACIER - STAHL

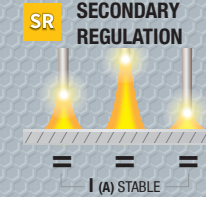
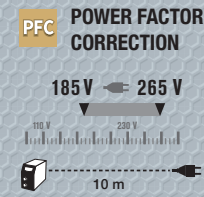

- SYNERGIC: Rings - Anneaux - Zugösen, Studs - Goujons - Gewindebolzen, Stainless steel nails - Tiges inox - Edeltahlnägel
- EXPERT Control: 1 Start-up - Amorce - Zündung, 2 Scouring (I & t) - Décapage - Abbeizen, 3 Arc (I & t) - Arc - Lichtbogen, 4 Hitching (I & t) - Accroche - Verklebung, 5 Height - Hauteur - Höhe



7 languages
FR, EN, DE, SP, IT, NL & RU



∅ max
Alu/Fe: 8 mm



∅ max
Alu: 10 mm
Fe: 13 mm



5 m, ∅ 50 mm² included
ARC PULL 700



SYNERGIC DIGITAL GUNS

★★★★★ **DRAWN ARC PROCESS**
Gas protection

UNIQUE Linear Motor

3 m, ∅ 25 mm²
included ARCPULL 200, 350 & COMBI ARCPULL

FULL CONTROL

Consumables for Gun
x2 059627
x1 059610

GYS POT ARCPULL 350 CAR BODY REPAIR

208 · 240V · 1~

350 A

x1 MANUAL

PFC SR AD

082953

included



Manual synergic gun 3 m, 25 mm²

ALU RING BOX 1.5 mm (AlSpec + AlMg3 + AlMgSi) 059429

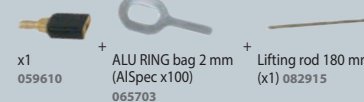

x1 059610

ALU RING bag 2 mm (AlSpec x100) 065703

Lifting rod 180 mm (x1) 082915

OPTIONS

details p.24

Weld 810 for ARCPULL 350 037489



GYS POT ARCPULL 700 CAR BODY REPAIR

380 · 480V · 3~

680 A

x1 MANUAL

SR IP 23

OPTIONS

details p.24

Weld 910 for ARCPULL 700 070967



068315 included

- Manual synergic gun 5 m, 50 mm²
- Arc Pull Rivet Box 700
- Lifting rod 180 mm (x1) 082915
- Ground studs holder ∅ 6 (x1) 075368, ∅ 8 (x1) 075375, ∅ 10 (x1) 075382
- Threaded holder ∅ 5 (x1) 076174, ∅ 6 (x1) 068391
- Double earth clamps 700 A, 3 m, 50 mm² 068605
- ALU RING BOX 1.5 mm (AlSpec + AlMg3 + AlMgSi) 059429
- Gas protection (x1) 068346

MADE IN FRANCE 60974-1	50/60 Hz	I ₂ A	SYNERGIC	TECHNOLOGY		U ₂ V	+AM- A	kW	OK	OK	LxWxH cm / kg
				Acier/Steel	Alu						
GYS POT ARCPULL 350 CAR BODY REPAIR	208 · 240V	6 m	10 · 350	Manual + Digital Gun Motion Control	Power Factor Correction	20.4 · 34V	16	11.9	OK	OK	48 x 36 x 30 / 17.4
GYS POT ARCPULL 700 CAR BODY REPAIR	3x 400V 3x 480V	5 m	50 · 680	Manual + Digital Gun Motion Control	—	22 · 44V	20 A (D) 16 A (D)	47.8 kW 45.7 kW	OK	OK	60 x 43 x 46 / 27.8



GYSPT ARC PULL 200, 350 & COMBI ACCESSORIES & CONSUMABLES

ACIER / STEEL / STAHL

x1 059634	x1 059641	x1 064065	x100 041561	x100 064034	x2 049000	x100 059573	x100 048157	x100 049000	x100 059603	x100 064607	x1 048157	x100 049383	x100 049413	x100 049420	x1 048164	x100 063969	x200 063990	x1 064041	x200 064003	x1 064058	x100 063976	
STEEL STUDS BOX 200 & 350 059443	x1	x1	x1	x100	x1	x100	x1	x100	x100	x100	x1	x100	x200	x1	x200	x1	x100					x1

ALU

x1 059634	x1 059641	x2 049000	x100 059573	x100 048157	x100 059580	x100 048164	x100 059597	x200 064010	x100 064041	x200 064027	x1 064058	x100 063983	
ALU STUDS BOX 200 & 350 059436	x1	x1	x1	x100	x1	x100	x1	x100	x200	x1	x100	x1	

	straight rings						twisted rings							
	Al-Special		AlMg3		AlMgSi		Al-Special		AlMg3 - x 50		AlMgSi - x 50			
box	n°1 1mm x100	n°4 1.5mm x100	n°8 2mm x100	n°2 1mm x100	n°5 1.5mm x100	n°3 1mm x100	n°6 1.5mm x100	n°1 1mm x50	n°4 1.5mm x50	n°2 1mm x50	n°5 1.5mm x50	n°3 1mm x50	n°6 1.5mm x50	
	059535	059559	065703	059498	059511	059450	059474	059542	059566	059504	059528	059467	059481	
box	ALU RING BOX 1 mm 059412		1mm x50		1mm x50		1mm x50		1mm x20		1mm x20		1mm x20	
box	ALU RING BOX 1.5 mm 059429		1.5mm x50		1.5mm x50		1.5mm x50		1.5mm x20		1.5mm x20		1.5mm x20	
sachet - bag	ALU RING BOX 2 mm 065703		2mm x100											

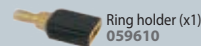

Earth clamp
Croco T400.70
043787



Double earth clamp
25 mm², 3 m, 350 A
070714

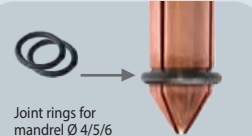

Joint rings for
mandrel Ø4/5/6
x2
060814

Mandrel support - Support porte-goujon x1 059634	Nozzle + pad - Buse + patin x1 059641	Ø2mm x1 064065	Ø4mm x2 049000	Ø5mm x1 048157	Ø6mm x1 048164	Ø7.1mm x1 064041	Ø8mm x1 064058
STUDS HOLDER BOX 350 064591	x1	x1	x1	x1	x1	x1	x1
ARCPULL DIFFICULT ACCESS BOX 350 070813	x1	x1					
Difficult access :							

x100 064607		x1 059634	x1 059641	x2 049000	x1 064683	x1 067721	x1 070738	x100 070745
ARCPULL RIVET BOX 1 350 - 24kN 064584	x100	x1	x1	x1	x1	x1	x1	x1
ARCPULL RIVET BOX 2 350 - 50 kN 073388		x1	x1				x1	x100

To be used with :

Extraction with GYSPRESS & adapters
details p.76



GYSPRESS + adapter 24kN for Ø 4
GYSPRESS + adapter 50kN for Ø 4 & 5

GYSPT ARC PULL 700 - ACCESSORIES & CONSUMABLES

x100 070745	x1 070738	x1 066151	x1 071377	x1 059641	x1 059610	x1 071384	x1
ARCPULL RIVET BOX 700 068452	x100	x1	x1	x1	x2	x1	x1

Gas protection (x1)
068346

Ground studs holders
Ø6 x1 075368
Ø8 x1 075375
Ø10 x1 075382

Threaded holders
Ø5 x1 076174
Ø6 x1 068391
Ø8 x1 068407



Double earth clamp
50 mm², 3 m, 700 A
068605



FAST DENT PULLING

STEEL / ACIER / STAHL

EASY TOOL CONNECTION



for GYSPOT 39.02/04, PRO 230/400, EXPERT 230/400, COMBISPOT 230



051690

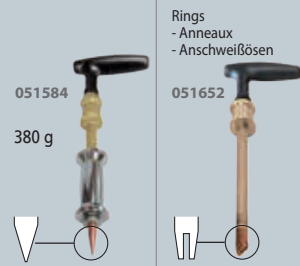

051584
380 g



051652

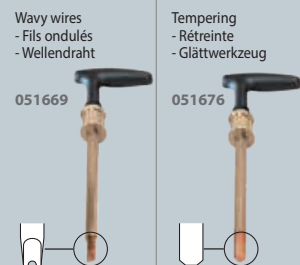

051669



051676



Manual dent-pulling bar - Poignée de tirage manuel 057289



EASYGUN 051317

Box of 3 electrodes for accessories 050822

MANUSPOT = 050679



Tools set and support for DENT 600, 800, 1000, 1600, Workstation & Dentstation



EASYGUN 051317



MANULINER 050471

3 m Ø 35 mm2

PATENTS REGISTERED NUMBERS 001652108-0003 EUROPEAN TRADEMARK & DESIGN

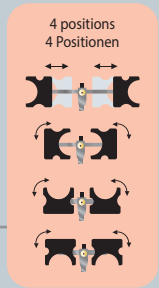

4 positions 4 Positionen

FAST & EASY



RINGMATIC 052154

included (x 50)



Option Gun adapter - Adaptateur pistolet 052499

MANULINER/GUN 056831

PATENTS REGISTERED NUMBERS 001652108-0003 EUROPEAN TRADEMARK & DESIGN



Pads - Patins (x2) 060807



Gun adapter - Adaptateur pistolet included 052499

DENT AXE PULLER 080508



Direct impact electrodes (x5) 050839

QUICK SPOT AIR GUN V2 057340



LIGHT 920 g

AIR

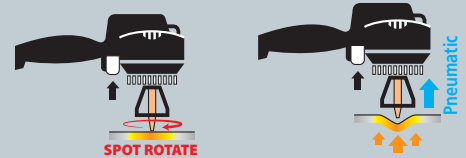

SPOT ROTATE

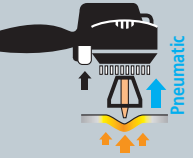

Gun adapter - Adaptateur pistolet 052826

MANU PULLER 079502



Included Alu 3 065178

Included Steel 079830

Included Alu 4 065185



ALU

ARC PULLER PREMIUM 065161



Included Alu 3 065178

Included Alu 4 065185

Pads - Patins (x2) 069008

ULTRA RESISTANT No deformation

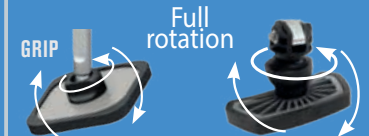

GRIP

Full rotation



Multi positions

ARC PULLER PREMIUM PRO 072572



Pads - Patins (x4) 074958

Included Alu 3 065178

Included Alu 4 065185

ALU PULLER

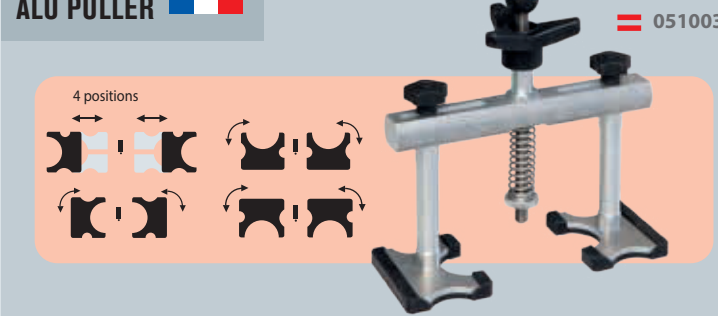

4 positions

= 051003

Included Alu 1 050938

Included Alu 2 050945

Patins - Pads (x2) 060807

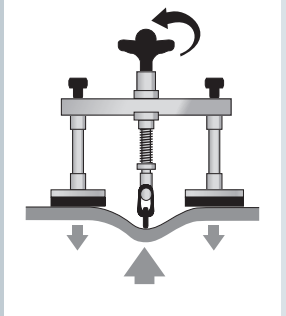

STRAIGHT LINE LAMP - Lampe ligne droite - Dentline-laser 056770



FAST PULLING RINGS - Anneaux de tirage rapide 058743

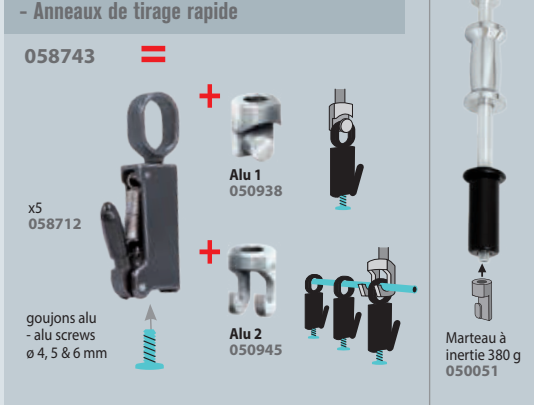

x5 058712

Alu 1 050938

Alu 2 050945

Marteau à inertie 380 g 050051

ALU HAMMERS - Marteaux alu 020986



PULLING BARS

3 PRODUCT LINES

1 STANDARD

2 PREMIUM



3 PREMIUM PRO



STANDARD

Levelling lever
- Levier de débosselage
- Zughebel

050686
↓ 1.6 kg
⊗ 79 x 12 x 17 cm / 1.9 kg

PATENTS REGISTERED NUMBERS
001652108-0002
EUROPEAN TRADEMARK & DESIGN

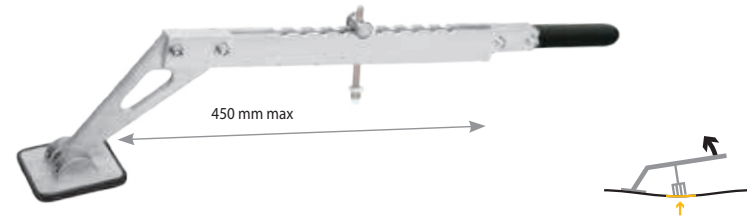

Double action levelling bar
- Barre de débosselage double action
- Zughebelbrücke

053564
↓ 2.5 kg
⊗ 77 x 12 x 13 cm / 3.2 kg

Licensed by
BETAG.Innovation

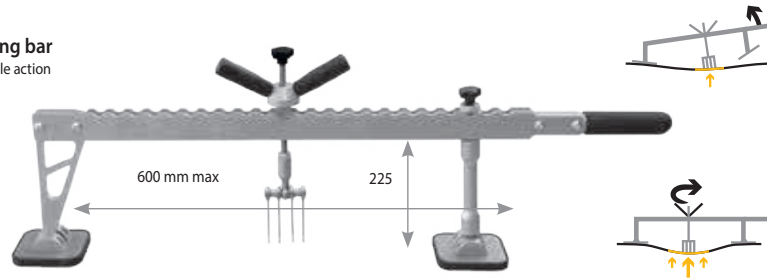

Levelling bar
- Barre de débosselage
- Zugbrücke

050693
↓ 3.4 kg
⊗ 87 x 17 x 19 cm / 4 kg

Licensed by
BETAG.Innovation

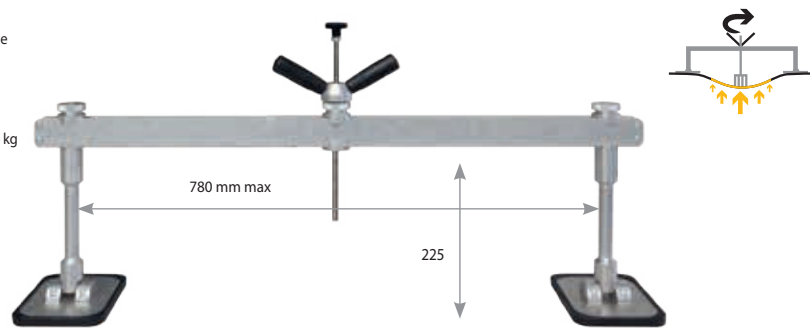

Reinforced scissoring bar
- Barre de tirage renforcée
- Scherenzugbrücke

050716
↓ 5.1 kg
⊗ 87 x 17 x 18 cm / 5.9 kg

PATENTS REGISTERED NUMBERS
001652108-0001
EUROPEAN TRADEMARK & DESIGN

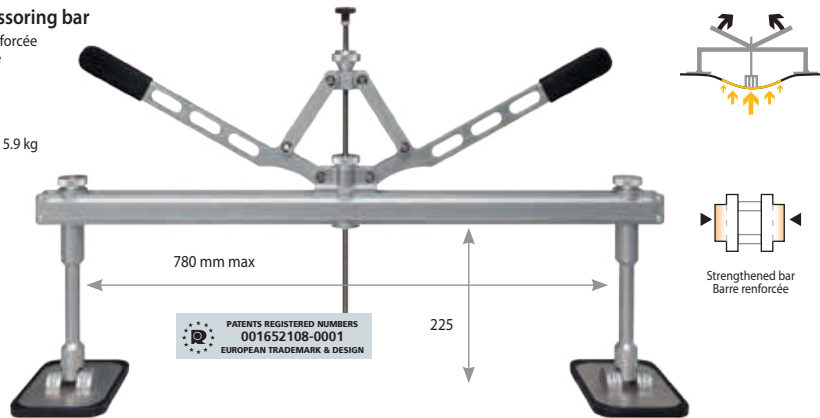

SLIDE & LOCK

Removable system : pads and pulling systems
Système amovible : patins et chariots de tirage

FEET



PULLING SYSTEM

only for 059313



LIGHTWEIGHT

Léger



GRIP 360

360° pads with grip
Patins à frein orientables à 360°



PREMIUM

Premium levelling lever
- Levier de débosselage Premium
- Premium Zughebel

059290
↓ 1.6 kg
⊗ 100 x 16 x 17 cm / 2.2 kg

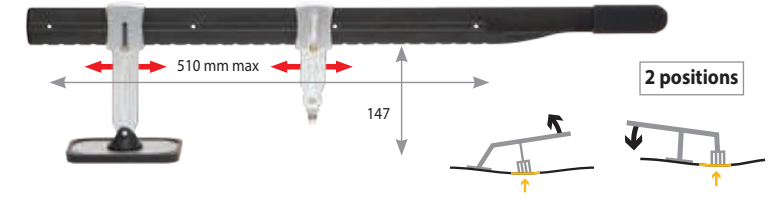

Premium levelling bar
- Barre de débosselage Premium
- Premium Zugbrücke

059306
↓ 2.8 kg
⊗ 79 x 30 x 13 cm / 3.2 kg

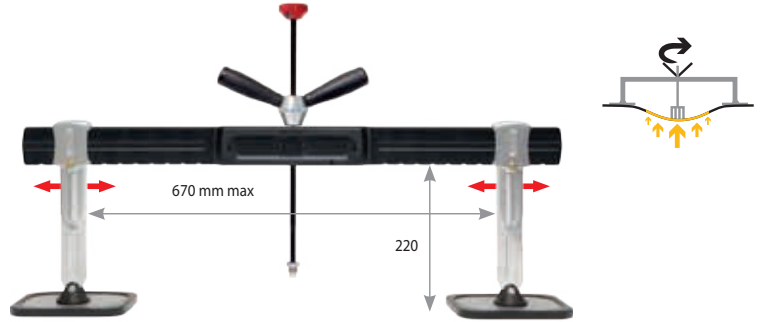

Premium scissoring bar
- Barre de tirage Premium
- Premium Scherenzugbrücke

058996
↓ 3.1 kg
⊗ 87 x 16 x 18 cm / 3.9 kg

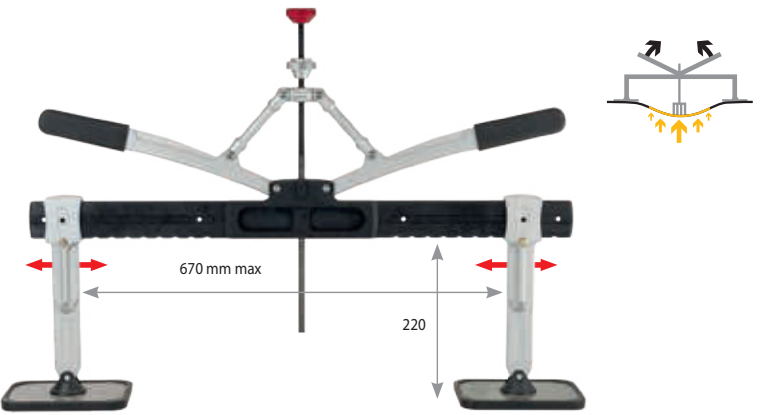

Premium 1200 scissoring bar
- Barre de tirage 1200 renforcée Premium
- Premium Scherenzugbrücke 1200

059313
↓ 5.6 kg
⊗ 127 x 26 x 9 cm / 6.2 kg

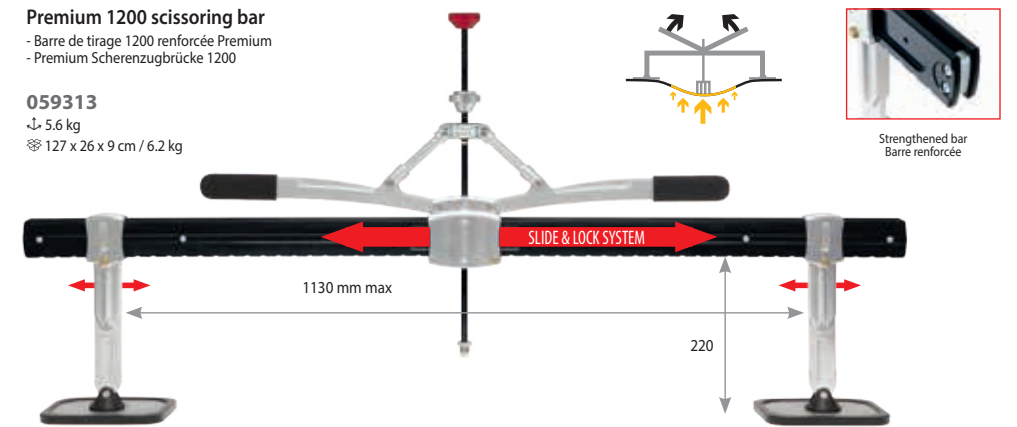

OPTIONS

Reinforced bar 1200 mm - Barre renforcée
051171

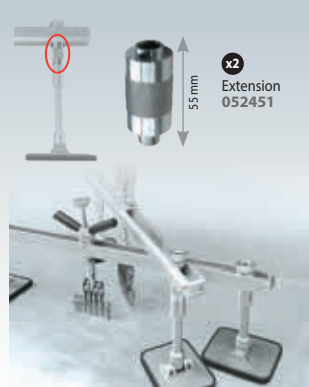
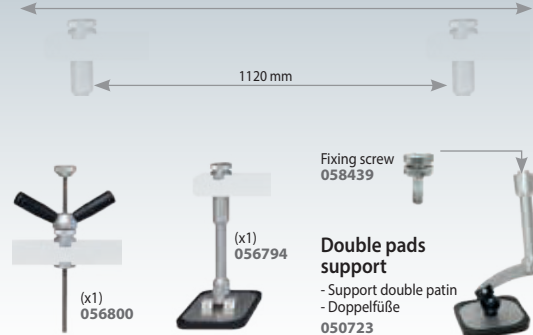

STANDARD

NEW



1 tooth hook
Ø M10 / M14
082021

STANDARD

PREMIUM (LONG FEET NEEDED)



4 tooth claw
Ø M10 / M14
049758

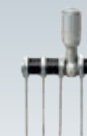

6 tooth claw
Ø M10 / M14
049734

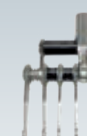

8 tooth claw
Ø M10 / M14
049741



Ring-Pulling
068995

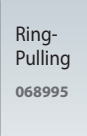

8 tooth claw for pulling chain
Ø M10 / M14
067745

PREMIUM



2 teeth hook
PREMIUM
Ø M14
059382



3 teeth hook
PREMIUM
Ø M14
059658

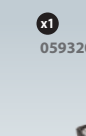

x1 059320

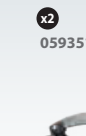

x2 059351

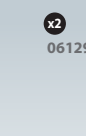

x2 061293

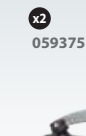

x2 059375



x1 072688



x1 059399

OPTIONS



069268



059399

SUPER ERGONOMIC



QUICK HOOK

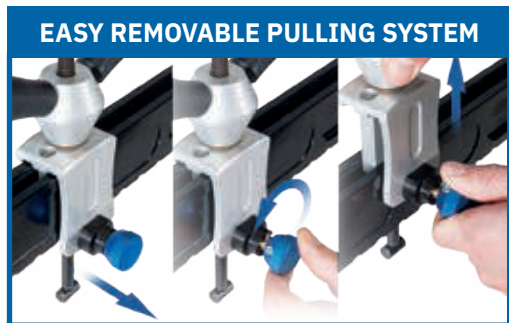
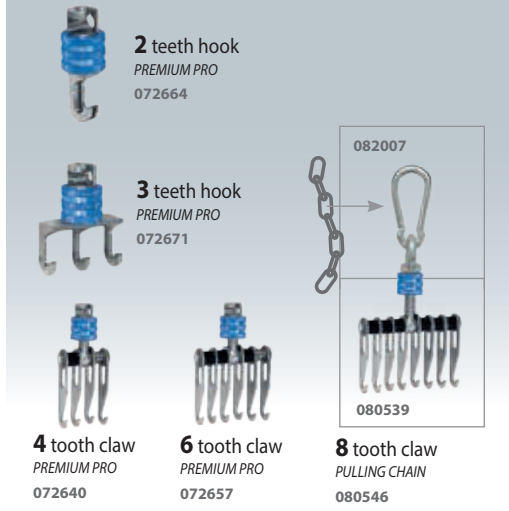

EASY REMOVABLE PULLING SYSTEM

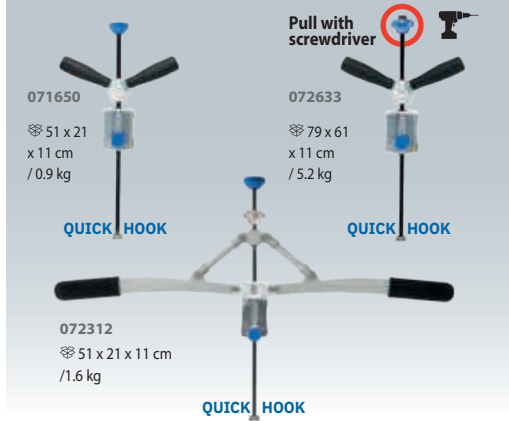

SLIDE & LOCK

Removable system : pads and pulling systems
Système de patins et chariots de tirage amovibles

PULLING SYSTEM

FEET

PREMIUM PRO

Premium Pro Levelling lever
- Levier de débosselage Premium Pro
- Premium Pro Zughebel

072619
↳ 1.6 kg
⊗ 87 x 17 x 18 cm / 2.3 kg

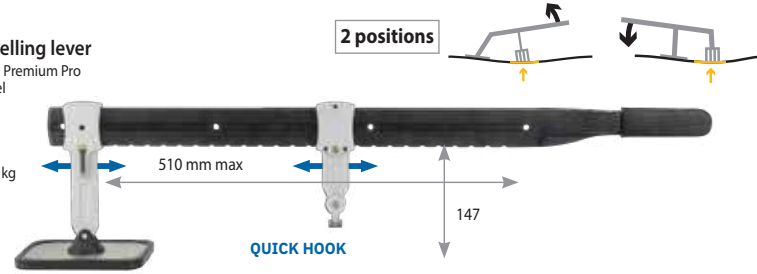

Premium Pro Levelling bar 900mm / Single feet
- Barre de débosselage Premium Pro 900 mm
- Premium Pro Zugbrücke 900 mm

071643
⊗ 120 x 26 x 8 cm / 4.4 kg
↳ 3.8 kg

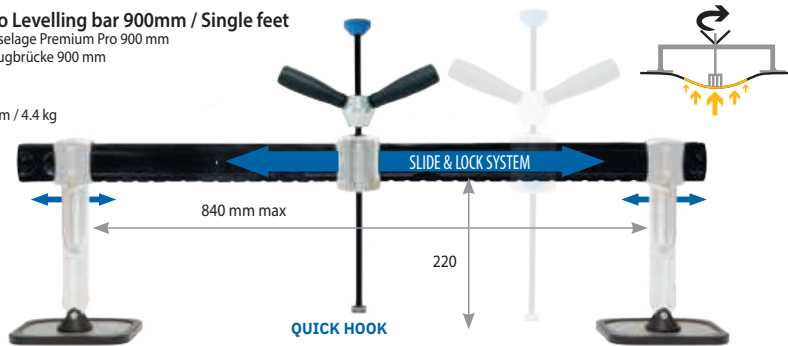

Premium Pro Levelling bar 900mm / Double feet
- Barre de débosselage Premium Pro 900 mm
- Premium Pro Zugbrücke 900 mm

080102
↳ 3.8 kg

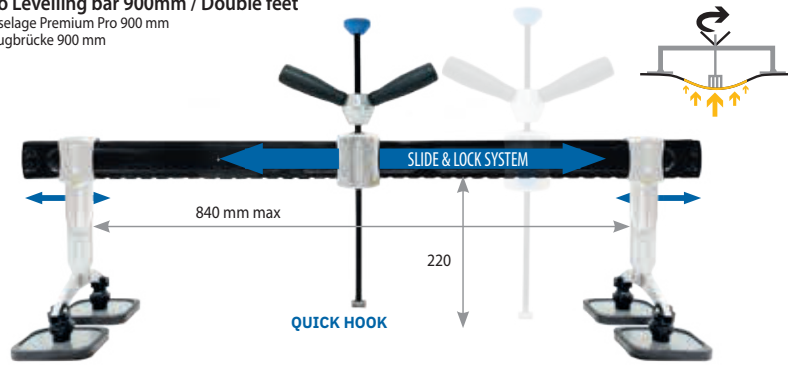

Premium Pro Scissoring bar 900mm
- Barre de tirage Premium Pro 900 mm
- Premium Pro Scherenzugbrücke 900 mm

072305
⊗ 103 x 30 x 13 cm / 5.2 kg
↳ 4.5 kg

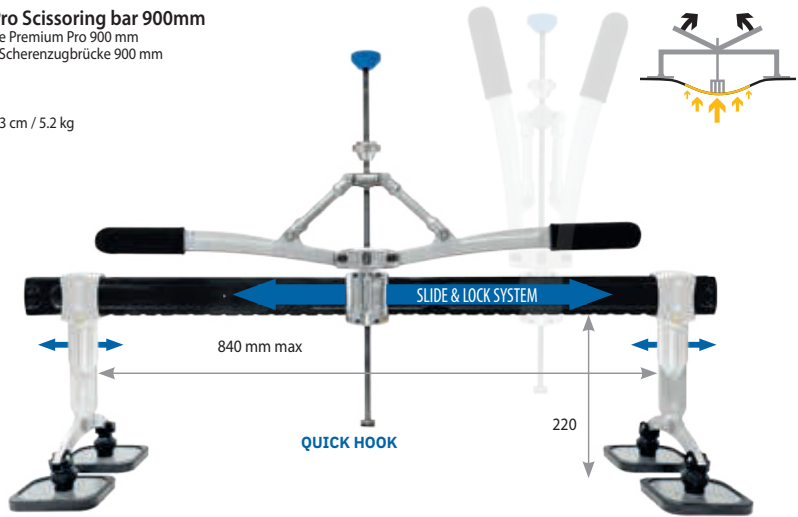

Premium Pro Scissoring bar 1150 mm
- Barre de tirage Premium Pro 1150 mm
- Premium Pro Scherenzugbrücke 1150 mm

072626
⊗ 124 x 7 x 7 cm / 3.1 kg



GRIP 360 GRIP 360+

360° pads with grip
Patins à frein orientables à 360°



STRENGTHENED (DOUBLE) BAR

Improved mechanical resistance
Résistance mécanique renforcée

X-CROSS

Possibility of crossing the bars
Possibilité de croiser les barres



OPTIONS

Single foot
- Pied simple
- Fuß

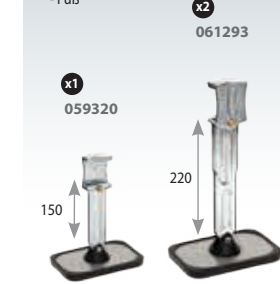

Double foot levelling bar
- Pied double patin
- Doppelfuß



PREMIUM BAR SMART HAND

for Premium & Premium Pro
072480

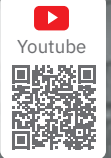
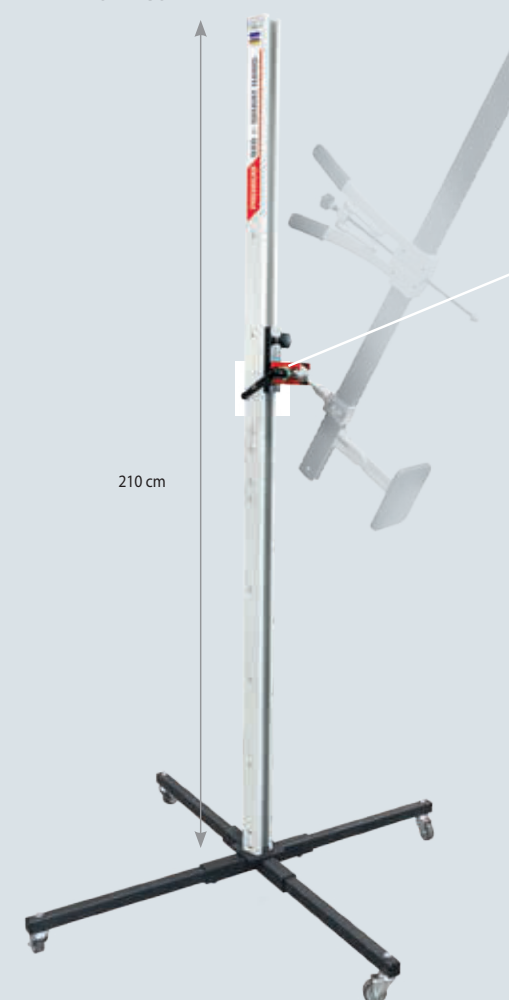



DENT PULLING WORKSTATIONS

**A COMPLETE SOLUTION
UNE SOLUTION COMPLÈTE
KOMPLETTLÖSUNGEN**

Compatibility

SPOT	Dent 600	Dent 1000	Universal 800	Weld 810	Weld 910	Dent 1600	Dent 1600 WD	Dentstation Pro WD
26/27.02	✓	✓	✓	✓		✓		✓
34.02/04	✓	✓	✓	✓		✓		✓
39.02/04	✓	✓	✓	✓		✓		✓
PRO 230/400	✓	✓	✓	✓		✓		✓
EXPERT 230/400	✓	✓	✓	✓		✓		✓
ALU 66	✓	✓	✓					
ALU PRO FV	✓	✓	✓			✓		✓
COMBI 230 E.PRO						✓		✓
ARCPULL 200/350				✓	✓	✓		✓
COMBI ARCPULL						✓		✓
ARCPULL 700					✓	✓		✓

Universal 800
 ↳ 60 x 48 x 83 cm
 17,6 kg
 ↳ 79 x 39 x 18 cm
 18,1 kg
 051331

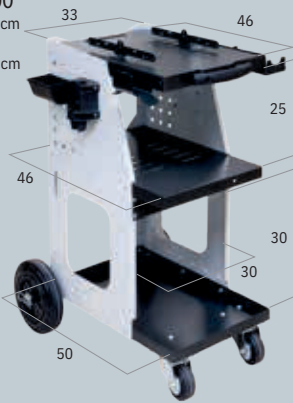

Weld 810
 ↳ 77 x 50 x 84 cm
 20,1 kg
 ↳ 80 x 51 x 14 cm
 21,6 kg
 037489

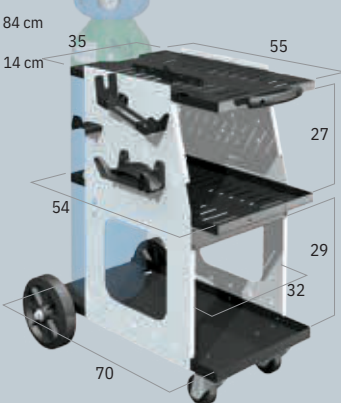

Weld 910
 ↳ 89 x 52 x 84 cm
 25 kg
 ↳ 80 x 52 x 22 cm
 27 kg
 070967

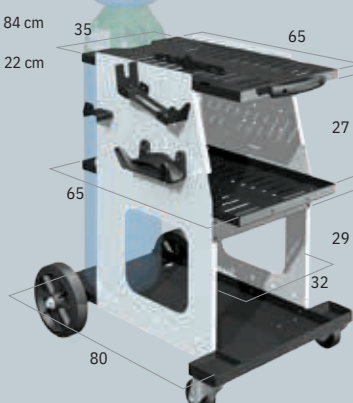

Dent 1600
 ↳ 70 x 69 x 161 cm
 / 35,8 kg
 ↳ 103 x 66 x 22 cm
 / 38,7 kg
 072596

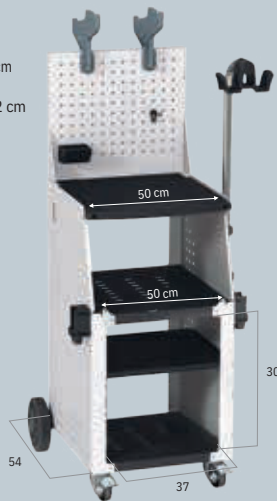

Dent 1600 WD
 ↳ 71 x 70 x 161 cm
 / 49,5 kg
 ↳ 103 x 66 x 22 cm
 / 52,4 kg
 072169

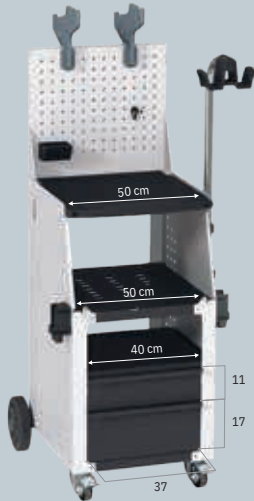

Dentstation Pro WD
 ↳ 90 x 71 x 161 cm
 / 65 kg
 ↳ 120 x 80 x 28 cm
 / 68,5 kg
 072800



CHARIOTS / TROLLEYS

Dent 600
 ↳ 44 x 35 x 62 cm / 6,9 kg
 ↳ 60 x 39 x 14 cm / 7,4 kg
 072831

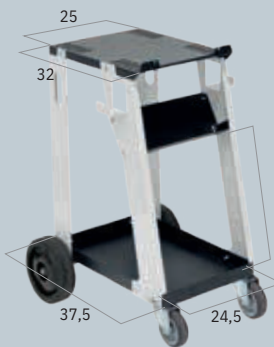

Dent 1000
 ↳ 44 x 35 x 98 cm / 9,3 kg
 ↳ 60 x 39 x 14 cm / 9,9 kg
 072848

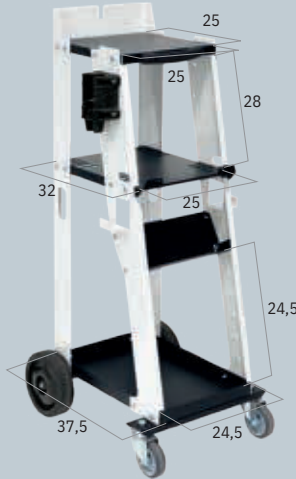

Cable support for Spot 800, 1600 & Dentstation Pro WD 052284



Protection cover - Housse de protection - Schutzhaube
 for Universal 800 062733
 for Spot 1600 & Dent 1600 048881
 for Dentstation Pro 059870

EASYLINER



EASYLINER 39.02

EASYLINER PRO 230

STEEL / ACIER / STAHL



GYSPOT (guns & consumables included)

39.02
053618
☎ : 058521

PRO 230

072398



INCLUDED ACCESSORIES



DENT 1000 072848



Dent box easy 053632



Levelling bar double action 053564

PROLINER



PROLINER 39.02

PROLINER PRO 230
PROLINER PRO 400

STEEL / ACIER / STAHL



GYSPOT (guns & consumables included)

39.02
035775

PRO 230

035799

PRO 400

035805

INCLUDED ACCESSORIES



UNIVERSAL 800 051331 + Cable support 052284



Dent box easy 050037



Levelling bar double action 053564



PROLINER ALU PRO FV

PROLINER ARCPULL 200

ALU



GYSPOT (guns & consumables included)

ALU PRO FV

035836

ARCPULL 200

065260



UNIVERSAL 800 051331 + Cable support 052284



Weld 810 037489 + Cable support 052284



Alu puller 051003



Arc puller premium 065161

SPEEDLINER STANDARD

COMPLETE
SYSTEM



PRO 230, 400 EXPERT 200, 230, 400 COMBI 230 E.PRO ARCPULL 200 + PRO 230, 400 ARCPULL 200 + EXPERT 200, 230, 400 ALU PRO FV

STEEL / ACIER / STAHL



GYSPT
(guns & consumables included)



GYSPT
(guns & consumables included)



GYSPT
(guns & consumables included)



GYSPT
(guns & consumables included)

PRO 230 074446	EXPERT 200 074460	COMBI 230 E PRO 074491	ARCPULL 200 + PRO 230 074507	ARCPULL 200 + EXPERT 200 074521	ALU PRO FV 074552
PRO 400 074453	EXPERT 230 074477		ARCPULL 200 + PRO 400 074514	ARCPULL 200 + EXPERT 230 074538	
	EXPERT 400 074484			ARCPULL 200 + EXPERT 400 074545	

INCLUDED ACCESSORIES

DENT 1600 072596	Cable support 052284	Levelling bar 850 mm 050693	052451
Magnetic earth 049666	Multihook heads 049758+049734	Levelling bar 050686	Ringmatic 052154
Alu puller 051003	Cable support 052284	Arc puller premium 065161	Cable support 052284 + 4 m support 059665
Stainless steel brush 044258	Alu Box 05 & 6 048195	Infrared Thermometer 079922	Hot air gun 650°C 066311

INCLUDED ACCESSORIES

DENT 1600 072596	Cable support 052284
Levelling bar 850 mm 050693	050693
Alu hammers 020986	Set of pencil punches with 6 teflon tips 052888
Multihook heads 049758	Alu puller 051003
Stainless steel brush 044258	Alu Box 05 & 6 048195
Infrared Thermometer 079922	Hot air gun 650°C 066311

Steel Speedliner without generator (excluded Ringmatic) : 035058



SPEEDLINER PREMIUM

★★★★
COMPLETE SYSTEM



PRO 230, 400



EXPERT 200, 230, 400



COMBI 230 E.PRO



ARCPULL 200
+ PRO 230, 400



ARCPULL 200
+ EXPERT 200, 230, 400



ARCPULL 200, 350

STEEL / ACIER / STAHL



GYSPOT
(guns & consumables included)



GYSPOT
(guns & consumables included)



GYSPOT
(guns & consumables included)

ALU



GYSPOT
(guns & consumables included)

PRO 230 073883	EXPERT 200 073906	COMBI 230 E PRO 073968	COMBI ARCPULL 074569	ARCPULL 200 + PRO 230 073975	ARCPULL 200 + EXPERT 200 073913	ARCPULL 200 073999	ARCPULL 350 083042
PRO 400 073890	EXPERT 230 073920			ARCPULL 200 + PRO 400 073982	ARCPULL 200 + EXPERT 230 073937	077317 (without HOT AIR GUN)	
	EXPERT 400 073944				ARCPULL 200 + EXPERT 400 073951		

INCLUDED ACCESSORIES

INCLUDED ACCESSORIES

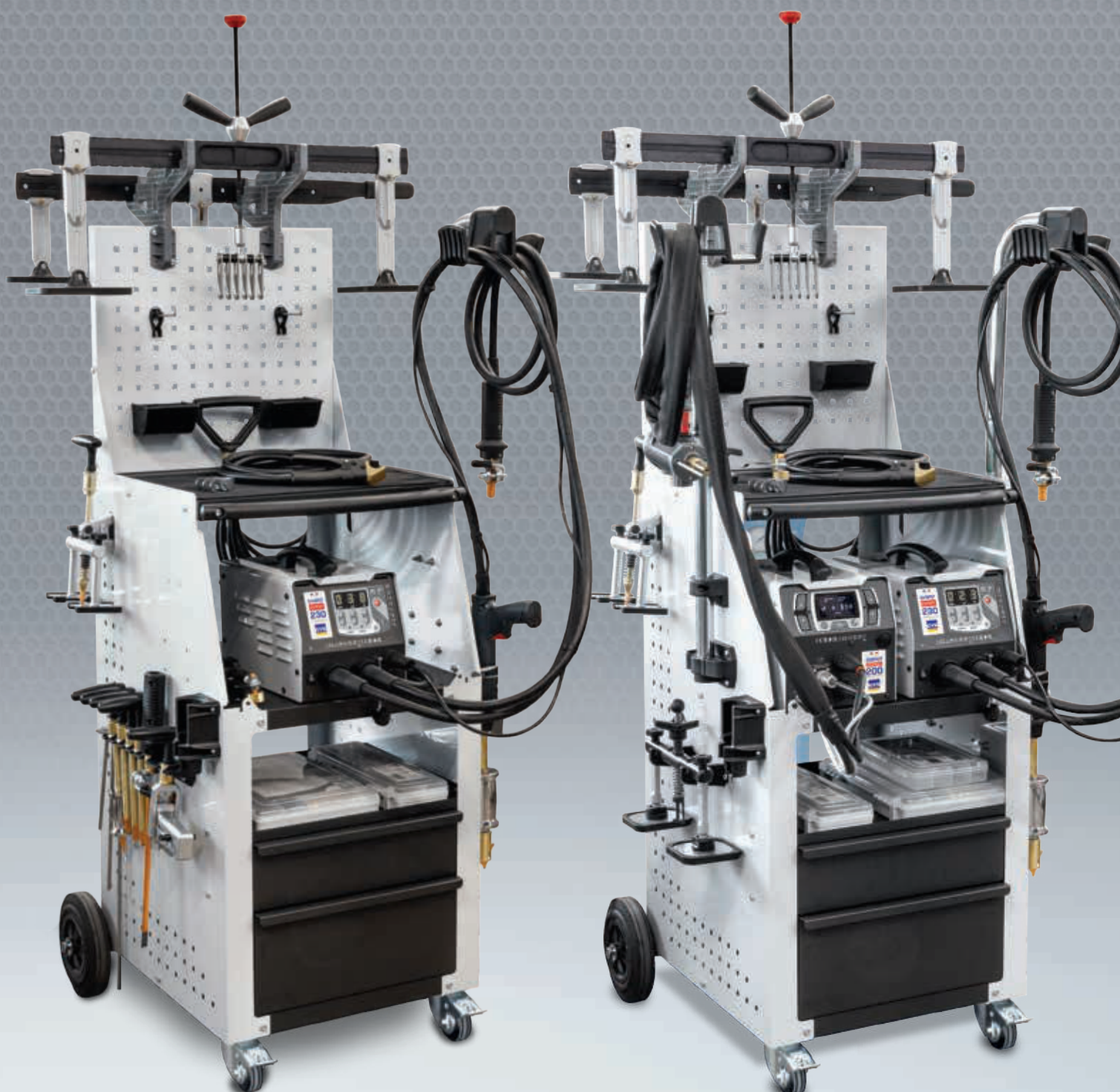

SPEEDLINER PREMIUM PRO



PRO 230, 400



EXPERT 200, 400
+ ARCPULL 200, 350



COMBI ARCPULL



ARCPULL 200, 350

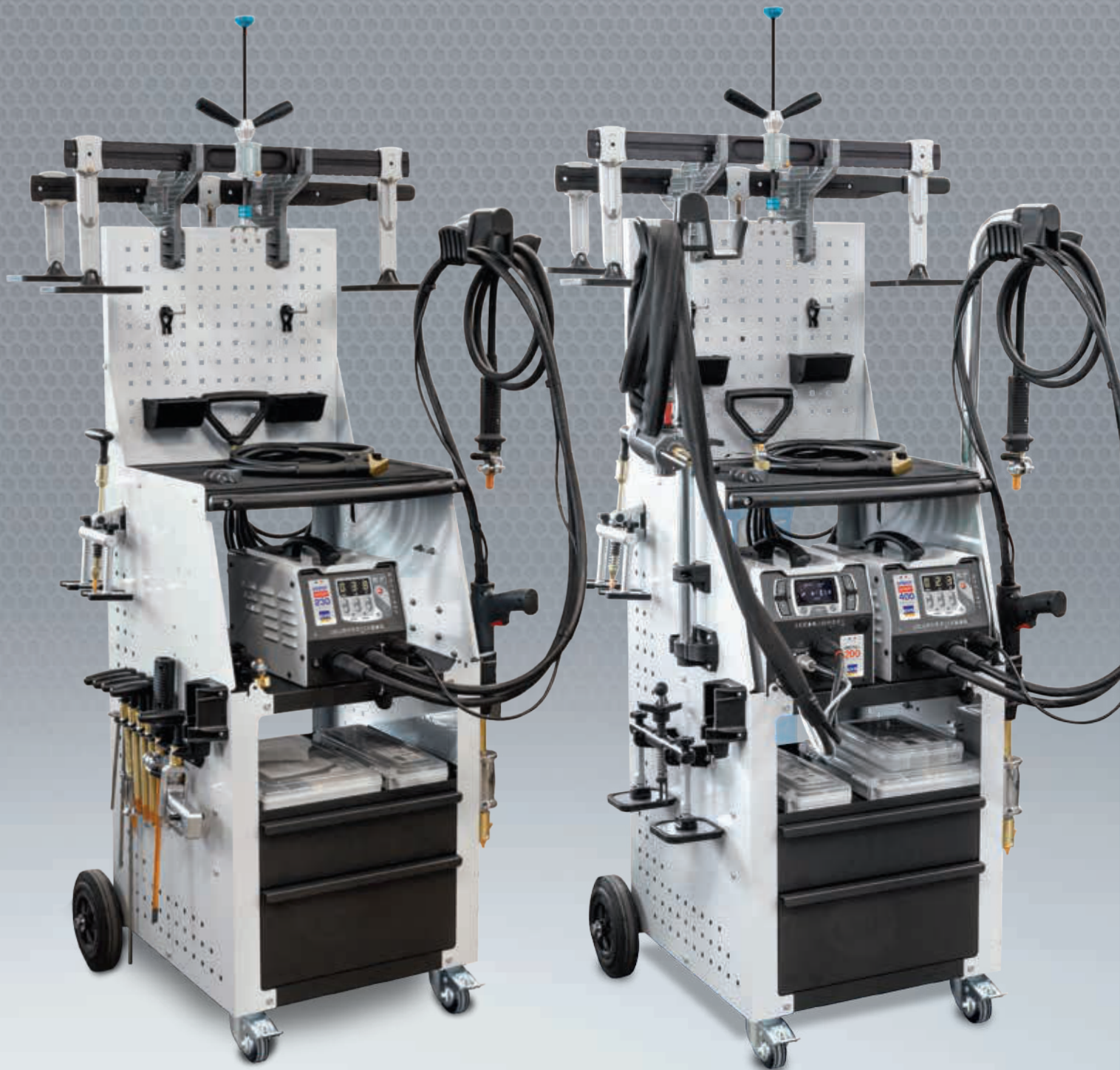

STEEL / ACIER / STAHL



GYSPOT
(guns & consumables included)

ALU + STEEL / ACIER / STAHL



GYSPOT
(guns & consumables included)



GYSPOT
(guns & consumables included)

ALU



GYSPOT
(guns & consumables included)

EXPERT 230	EXPERT 400	EXPERT 400 + ARCPULL 200	EXPERT 400 + ARCPULL 350	COMBI ARCPULL	ARCPULL 200	ARCPULL 350
080201	080218	080232	083028	080225	080256	083035
		EXPERT 200 + ARCPULL 200				
		080553				

INCLUDED ACCESSORIES

Dent 1600 WD 072169	Premium Pro levelling bar 900 mm 071643
Ringmatic 052154	Premium Pro levelling bar 072619
Manual pulling handle 057289	Manuspot 050679
3 lifting rods 050792 Dent box consumables 051515	Premium Pro teeth hook 072671 + 072664 + 072640
Cable support 052284 4 m support 059665 Arc Puller Premium Pro 072572	Magnetic earth 049666

INCLUDED ACCESSORIES

Dent 1600 WD 072169	Alu Ring Box 1 mm
072664	4 m support 059665
Premium Pro levelling bar 900 mm 071643	Arc Puller Premium Pro 072572
Set of pencil punches with 6 teflon tips 052888	230V Infrared Thermometer 079922 Hot air gun 650°C 066311
Alu hammers 020986	3 lifting rods 050792
Stainless steel brush 044258	

DENTSTATION STANDARD



39.02, 39.04 PRO 230, 400 EXPERT 200, 230, 400 COMBI 230 E.PRO ARCPULL 200 + PRO 230, 400 ARCPULL 200 + EXPERT 200, 230, 400

*** COMPLETE SYSTEM

STEEL / ACIER / STAHL



GYSPOT (guns & consumables included)

ALU + STEEL / ACIER / STAHL



GYSPOT (guns & consumables included)



GYSPOT (guns & consumables included)

39.02	PRO 230	EXPERT 200	COMBI 230 E PRO	ARCPULL 200 + PRO 230	ARCPULL 200 + EXPERT 200
078161	078208	078321	078529	078222	078338
39.04	PRO 400	EXPERT 230		ARCPULL 200 + PRO 400	ARCPULL 200 + EXPERT 230
078185	078260	078369		078284	078384
		EXPERT 400			ARCPULL 200 + EXPERT 400
		078444			078468



INCLUDED ACCESSORIES

<p>Dentstation Pro WD 072800 Fixing kit 051362</p>	<p>Double pads 050723</p>	<p>Levelling bar 850 mm 050693</p>	<p>Scissoring bar 050716</p>
<p>Magnetic earth 049666</p>	<p>Multihook heads 049758 +049734 +049741</p>	<p>Levelling lever 050686</p>	<p>Strengthened bar 1200 mm 051171 Extensions (x2) 052451</p>
<p>Fast pulling rings (x5) 058712 + Alu puller 051003</p>	<p>Manuspot 050679</p>	<p>Dent box consumables 051515 3 lifting rods 050792 Empty box 320x113mm</p>	<p>Manual pulling handle 057289</p>
<p>Cable support 052284</p>	<p>Arc puller premium 065161</p>	<p>Cable support 052284 + 4 m support 059665 + Flanges (x 2) 062146</p>	<p>Ringmatic 052154</p>

DENTSTATION PREMIUM



PRO 230, 400



EXPERT 200, 230, 400



COMBI 230 E.PRO
COMBI ARCPULL



ARCPULL 200
+ PRO 230, 400



ARCPULL 200
+ EXPERT 200, 230, 400

★ ★ ★ ★
COMPLETE SYSTEM

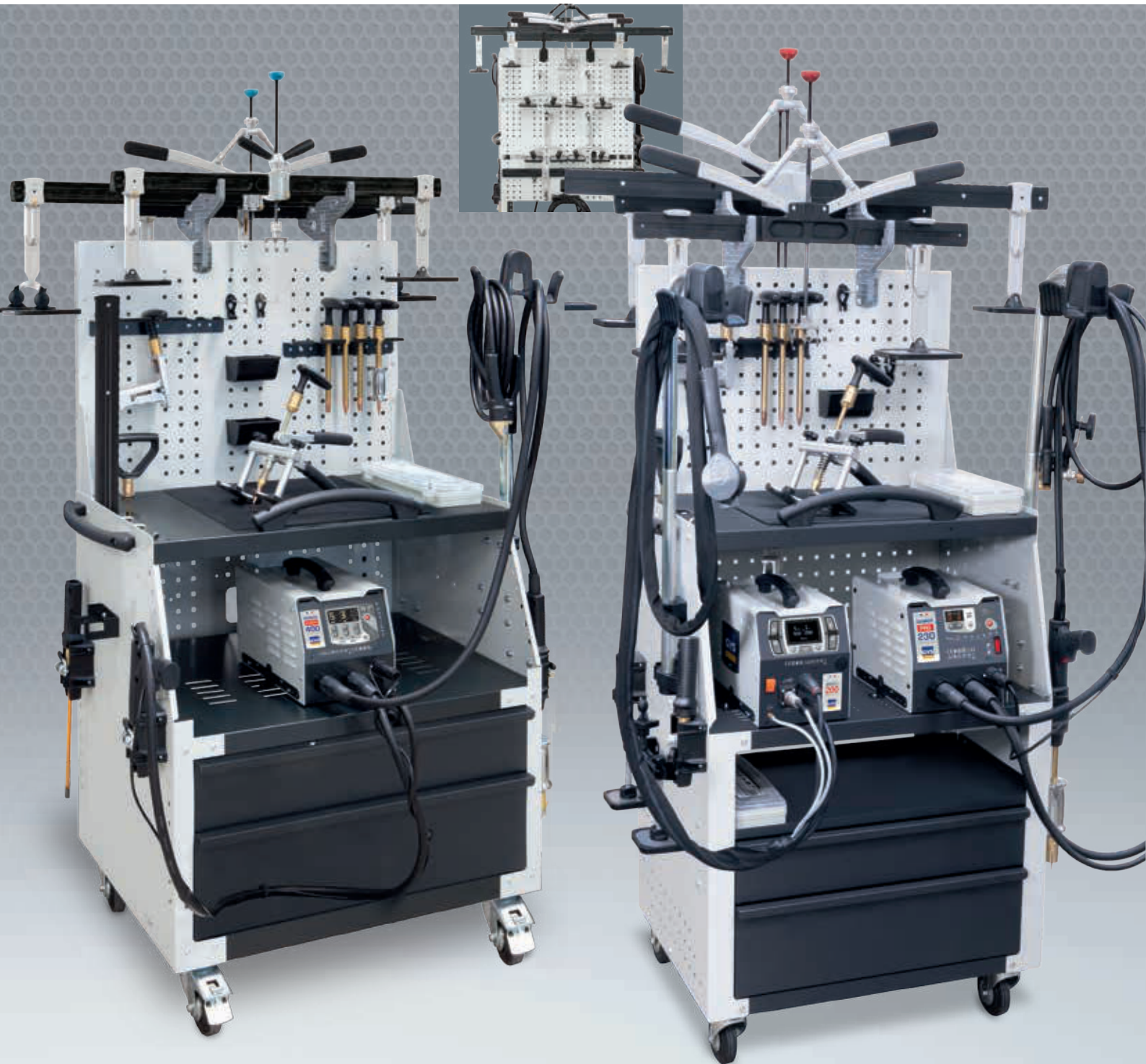

STEEL / ACIER / STAHL



GYSPOT
(guns & consumables included)

ALU + STEEL / ACIER / STAHL



GYSPOT
(guns & consumables included)



GYSPOT
(guns & consumables included)

PRO 230 078239	EXPERT 200 078345	COMBI 230 E PRO 078543	COMBI ARCPULL 078567	ARCPULL 200 + PRO 230 078253	ARCPULL 200 + EXPERT 200 078352
PRO 400 078291	EXPERT 230 078406			ARCPULL 200 + PRO 400 078314	ARCPULL 200 + EXPERT 230 078420
	EXPERT 400 078482				ARCPULL 200 + EXPERT 400 078505

INCLUDED ACCESSORIES

x6 x2	Manuspot 050679	Premium levelling bar 720 mm 059306	Premium levelling lever 059290
Dentstation Pro WD 072800 Fixing kit 051362	Hook head 049734 + 059658 + 059382	Premium scissoring bar 720 mm 058996	Premium scissoring bar 1200 mm 059313
Magnetic earth 049666	Premium double pads support 150 mm (x2) 059351 + 220 mm (x2) 059375	Dent box consumables 051515 3 lifting rods 050792 Empty box 320x113mm	Manual pulling handle 057289
		Ringmatic 052154	

Fast pulling rings (x5) 058712 Alu puller 051003 Cable support 052284	Cable support 052284 4 m ² support 059665 Flanges (x 2) 062146 Arc puller premium 065161	Arc puller premium 065161 Cable support 052284 4 m ² support 059665 Flanges (x 2) 062146
---	---	---

DENTSTATION PREMIUM PRO



EXPERT 230, 400



COMBI ARCPULL



EXPERT 400 + ARCPULL 200, 350



ARCPULL 200, 350

STEEL / ACIER / STAHL



1 BOX GYS SPOT (guns & consumables included)

ALU + STEEL / ACIER / STAHL



1 BOX GYS SPOT (guns & consumables included)

ALU



1 BOX GYS SPOT (guns & consumables included)

EXPERT 230	EXPERT 400	EXPERT 400 + ARCPULL 200	EXPERT 400 + ARCPULL 350	COMBI ARCPULL	ARCPULL 200	ARCPULL 350
080133	080140	080164	083004	080157	080461	083011

INCLUDED ACCESSORIES



1 BOX Dentstation Pro WD 072800



Premium pro levelling bar 900mm 071643



Premium pro levelling lever 072619
Premium pro bar 1184 mm 072626



Manuspot 050679

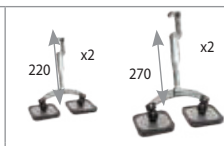

x2 220 x2 270
(x2) 059375 + (x2) 072688



072664 + 072671 + 072640 + 072657



071650 + 072312

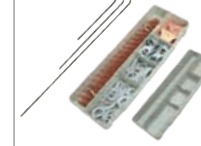

Dent box consumables 051515
3 lifting rods 050792
Empty box 320x113mm



Magnetic earth 049566
Ringmatic 052154
Manual pulling handle 057289

1 BOX STEEL ACCESSORIES PACK V2 080126

INCLUDED ACCESSORIES



1 BOX Dentstation Pro WD 072800



Premium pro levelling bar 900mm 071643 (x2) 059375



072664 + 072640 + 071650 Alu Ring Box 1 mm 059412



Alu hammers 020986 Arc Puller Premium Pro 072572

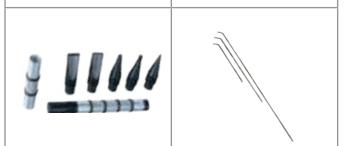

Set of pencil punches with 6 teflon tips 052888 3 lifting rods 050792



Stainless steel brush 044258
Infrared Thermometer 079922
Hot air gun 650°C 066311
4 m³ support 059665

1 BOX ARCPULL ACCESSORIES PACK 080485

+



Cable support 052284 4 m³ support 059665 Arc Puller Premium Pro 072572

1 BOX ALU ACCESSORIES PACK 073838





PULLING SYSTEMS

AIRFIX DRAW ALIGNER	38
DRAW ALIGNER	40
FRAME STRAIGHTENING	42



DRAW ALIGNER



- Designed for
- ★ TIME SAVING
 - ★ DURABILITY
 - ★ MAXIMUM GRIP

4 pads :
**Seal protection,
Perfect stability**

4 patins : protection du joint, stabilité parfaite
4 Pads: Dichtungsschutz, perfekte Stabilität
4 piedini: protezione sigillata, perfetta stabilità



Quick & easy set up

Compact & light
31 kg

No tools

Fast installation

Ground anchor by suction

Ancrage au sol par aspiration : installation rapide
Verankerung durch Vakuumbildung – schnell einsatzfähig
Ancoraggio a terra: installazione rapida

Low noise

Integrated silencer

Smart maintenance

- No glue
- No tools

Pads - Patins (x2) 069008

Plate seal - Joint de plaque 079571



AIRFIX DRAW ALIGNER

Air 5-8 bars
077379
080669

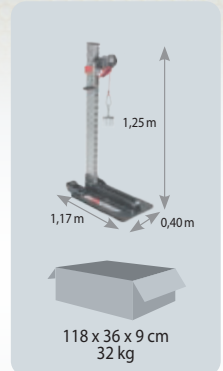

350 kg
Uniform pulling force
Force de tirage uniforme
Gleichmäßige Zugkraft
Forza di spinta uniforme

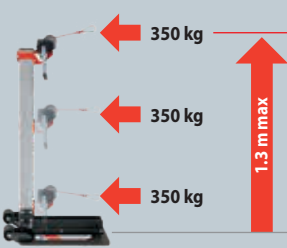

Precision
All directions

Down-pulling
Rocker panel
- Bas de caisse
- Schweller
- Sottoporta

Up-pulling
Upper-parts
- Parties hautes
- Oberteile

Options

Welding sheets kit
- Kit plaques à souder
083493

NEW

25 mm (x1 included)	38 mm (x1 included)	50 mm (x1 included)	75 mm (x1 included)
x5 083509	x5 083516	x5 083523	x5 083530

12 tooth claw
- Griffe 12 dents
082229

Option

XL mast for Airfix Draw Aligner
- Mât XL - XL-Mast
083714

Ergonomic

350 kg

350 kg

350 kg

1.30 m → 2.05 m

200 cm

118 x 27 x 25 cm
21 kg

NEW 07/2024



PULLING SYSTEMS

**DRAW ALIGNER**

Draw aligner - Équerre de tirage - Schnellausbeul-Richtausleger
052475

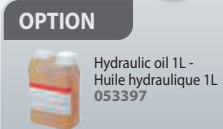
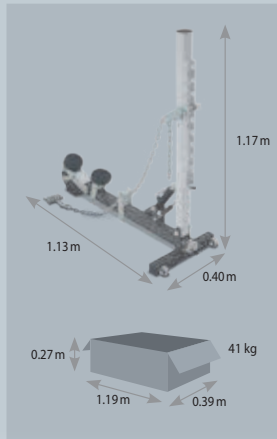
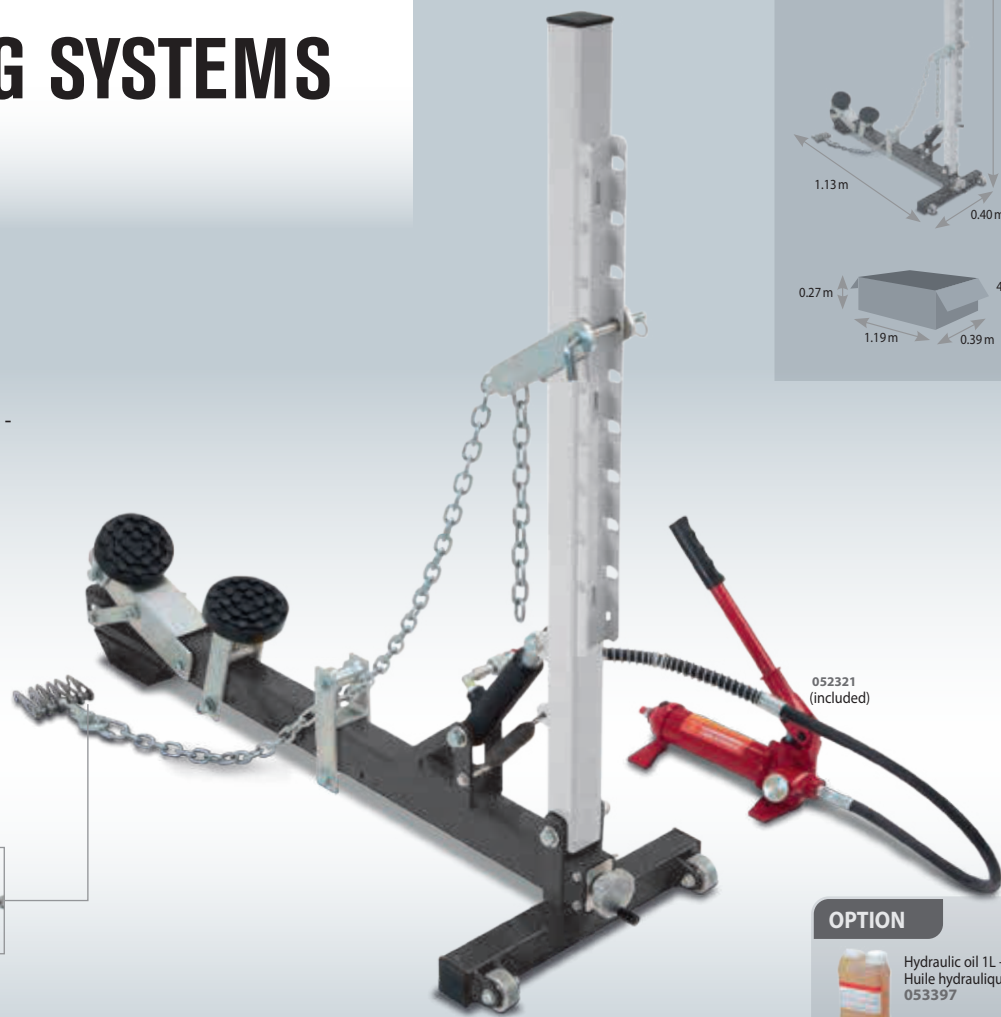
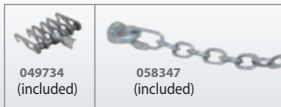
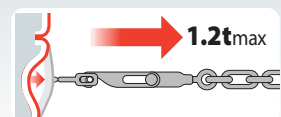
**INCLUDED**

Wedge for rocker panel - Cône pour bas de caisse

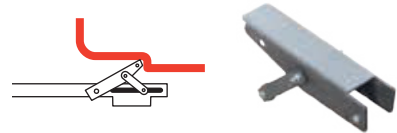

Pads kit for rocker panel - Kit patins pour bas de caisse

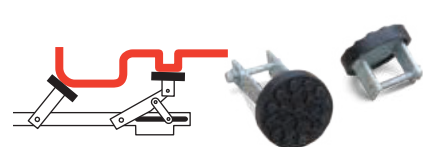
**OPTION**

Rocker panel arms for draw aligner - Bras de bas de caisse - Abstütztraverse für Richtausleger

052581

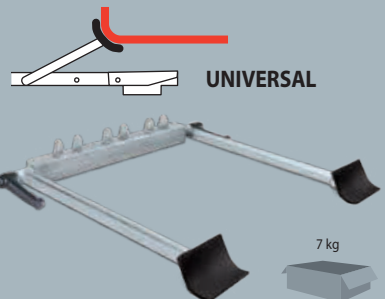
**UNIVERSAL**

7 kg

OPTION

12 tooth claw for pulling chain
082229

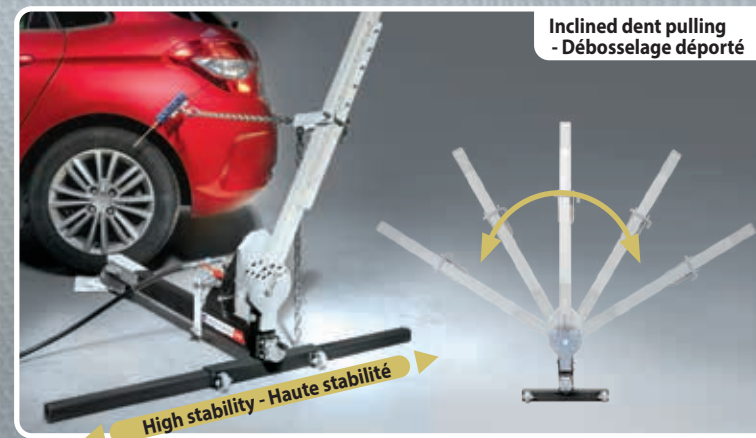
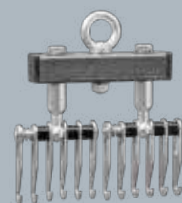
**DRAW ALIGNER PRO**

069244

**INCLUDED**

Plate under the wheel - Cône sous roue
Compatible with Draw Aligner & Draw Aligner Pro 076693



Wedge for rocker panel - Cône pour bas de caisse

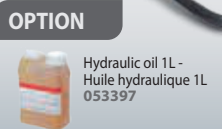
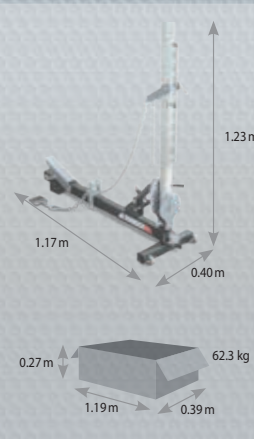
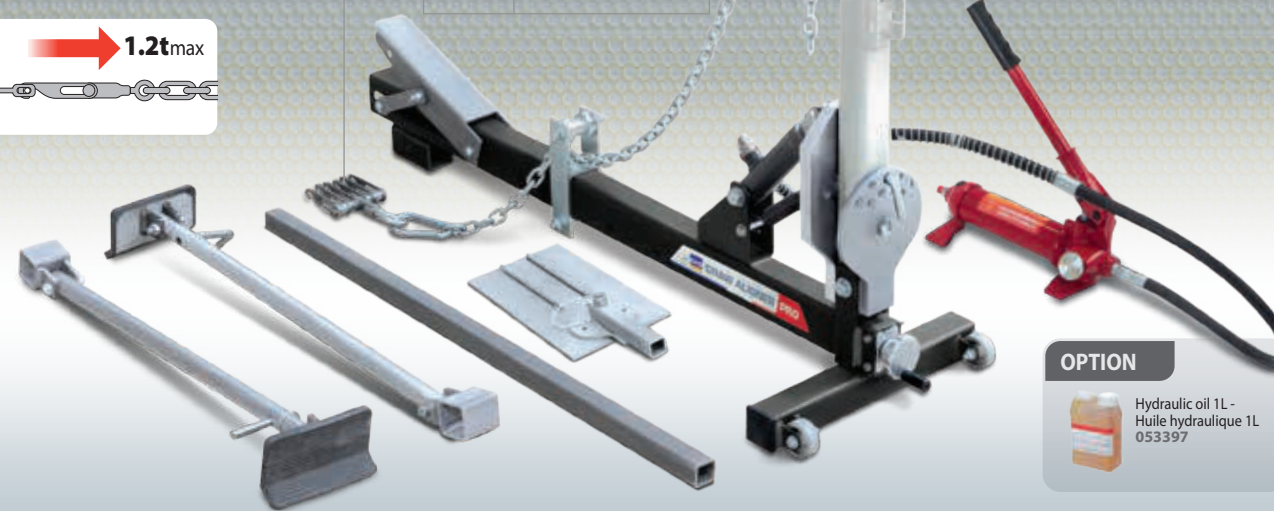
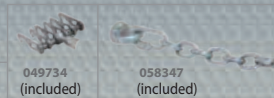
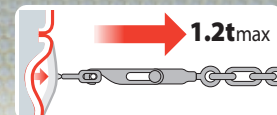
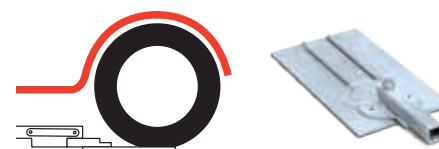
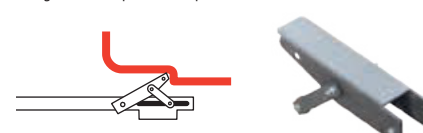

Rocker panel arms and stabilisation bar - Kit bras de bas de caisse et barre de stabilisation

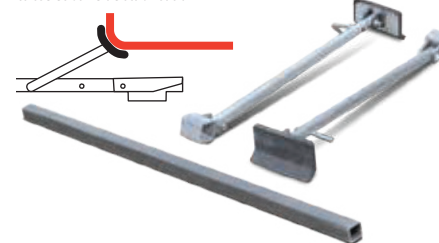
**OPTIONS**

Pads kit for rocker panel - Kit patins pour bas de caisse
071278

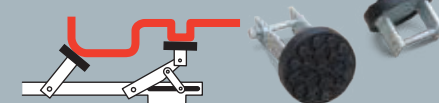

ELECTRO POWER - Zug-Druckpresse

with accessories :
057425



INCLUDED

Accessories kit :
425x620x150 mm
Accessories kit
Total weight: 20 kg

057418



Standard kit :
425x620x210 mm
Standard kit
Total weight: 18 kg

057401



Li-Ion battery
058514

OPTION

Pince écarteur
079496

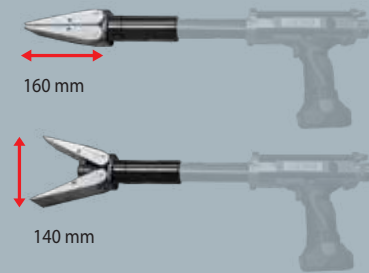

160 mm

140 mm

-PULLING POWER: 5 Ton.
-PUSHING POWER: 5 Ton.
-PISTON
-STROKE: 130 mm

Spreading / Estensione

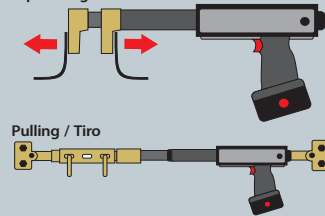

Pressing / Compressione

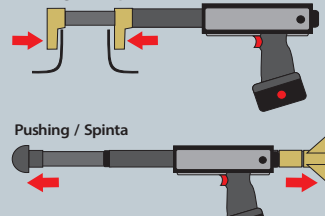

Pulling / Tiro

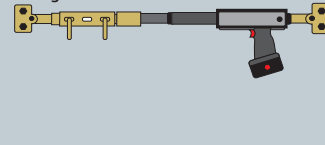

Pushing / Spinta

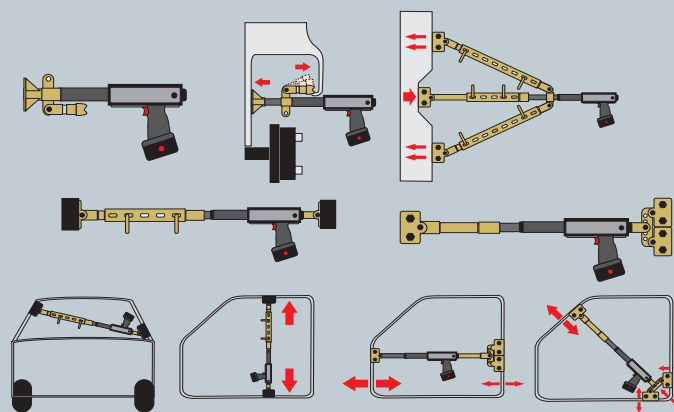
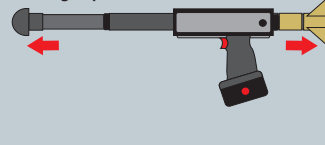

ANCHOR BAR - Barre d'ancrage - Türspanner

MADE IN TAIWAN

053045

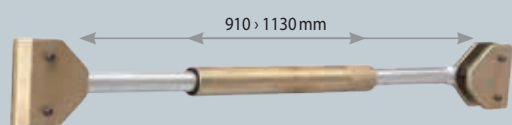

910 > 1130 mm

053052



1540 > 1930 mm



INERTIA HAMMER KIT - Kit marteau à inertie - Ausziehhammer kit

Inertia hammer kit
- Kit marteau à inertie
- Ausziehhammer kit
051928

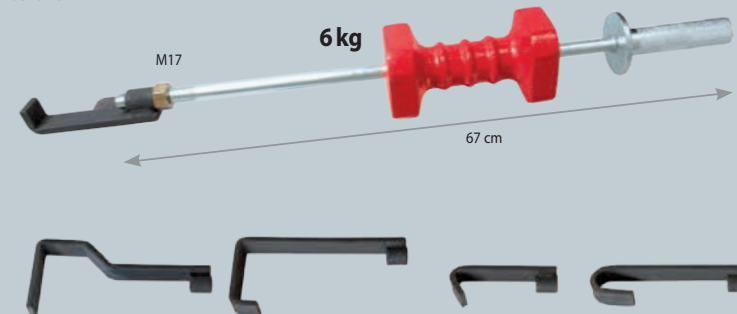

6 kg

67 cm

POWER-PULLER 4T

059740



HIGH QUALITY

HYDRAULIC CYLINDER KIT - Coffret vérin hydraulique - Hydraulischer Drucksatz

MADE IN CHINA

OPTION

BASIC 4T
052345

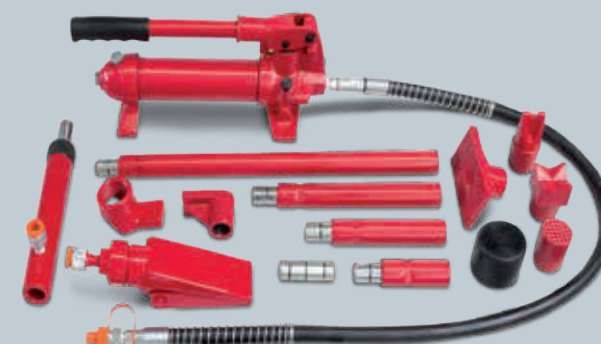

BASIC 10T
052338

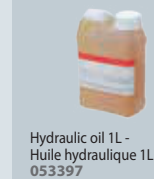

Hydraulic oil 1L -
Huile hydraulique 1L
053397

PRO 4T
057432



PRO 10T
057449



MEASURING TOOLS - Mesures - Vermessung

BODYMETER, Mechanical measurements

052130



250 > 2230 mm

GYSMETER, Electronic measurements

052093

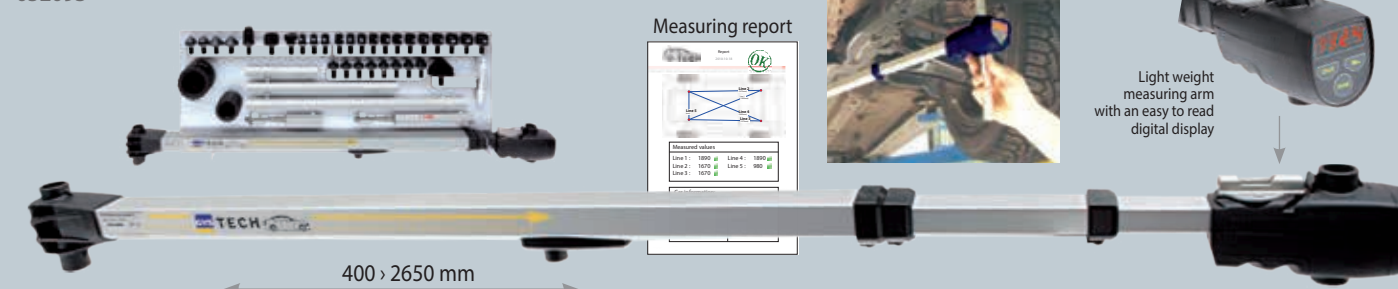

400 > 2650 mm

Measuring report

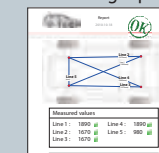

Light weight
measuring arm
with an easy to read
digital display



SWIVEL CLAMP
- Pince pivotante

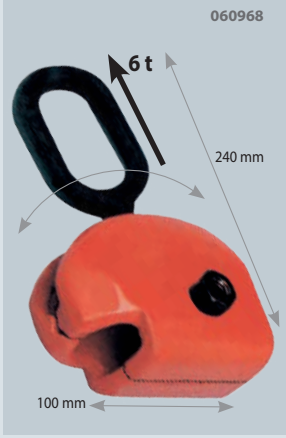

PULL CLAMPS - Pincés de tirage - Ziehwerkzeuge

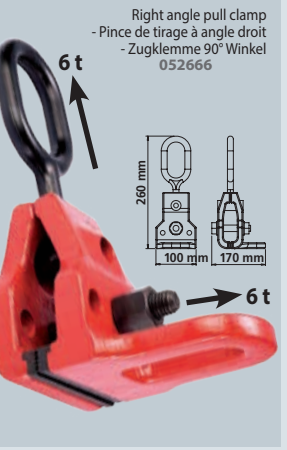
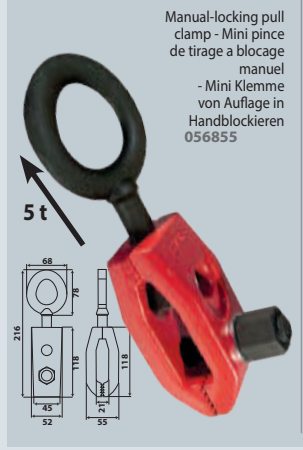

PULL HOOK - Crochet de tirage - Ziehwerkzeuge

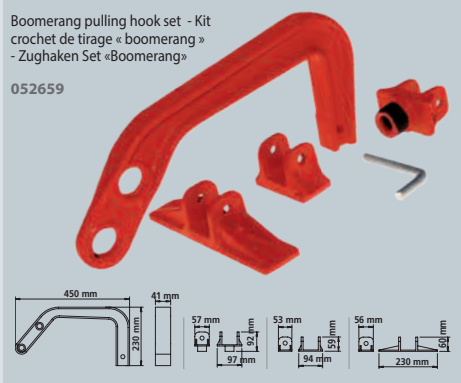

ARCH HOOKS - Passage de roue

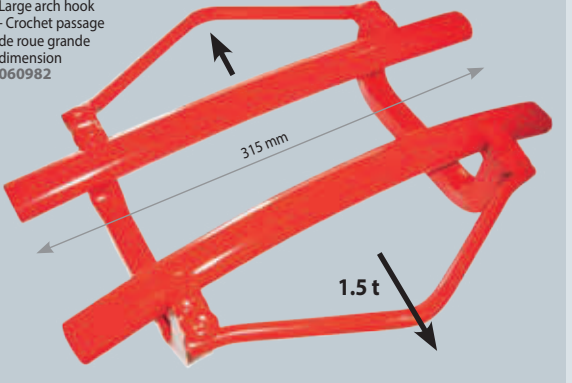
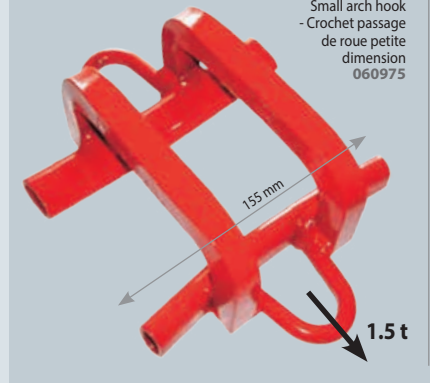

PULLING CHAIN - Chaînes de tirage - Ziehwerkzeuge

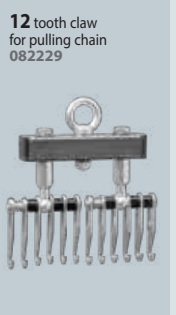
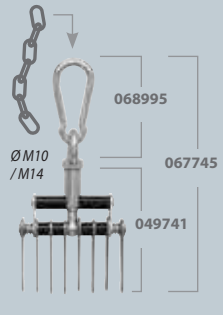
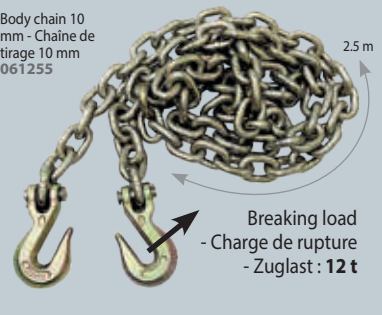
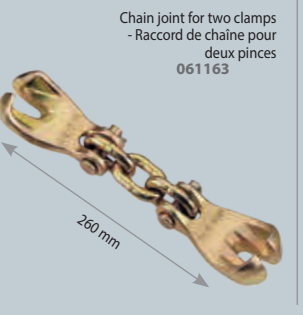
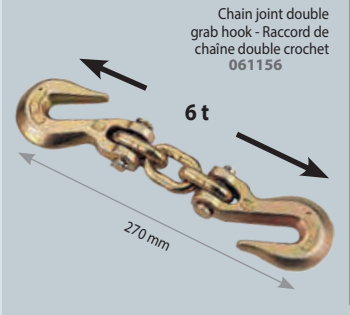

WIDE PULL CLAMPS - Pincés de tirage larges

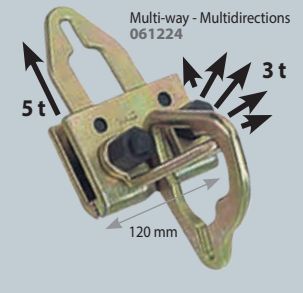
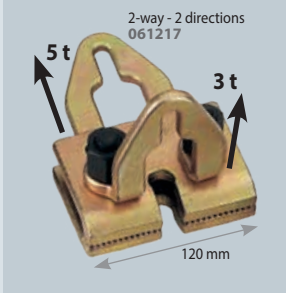

SMALL PULL CLAMPS - Pincés de tirage faible largeur

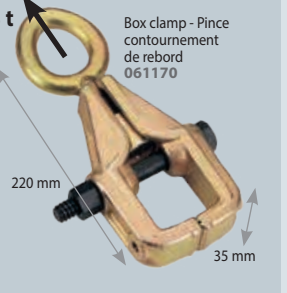
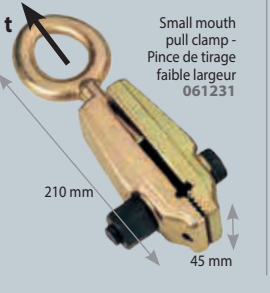

MULTIPLE PULL CLAMP - Pince de tirage multiple

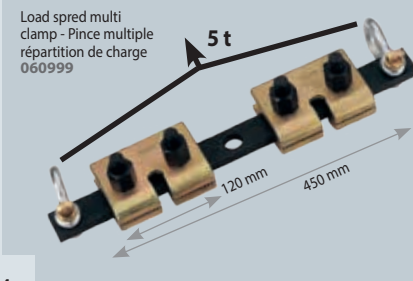

45 MM SCISSORS CLAMP - Pince ciseaux largeur 45 mm

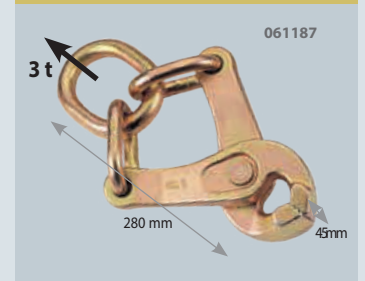

90 DEGREE CORNER CLAMP - Pince de tirage pour angle 90°

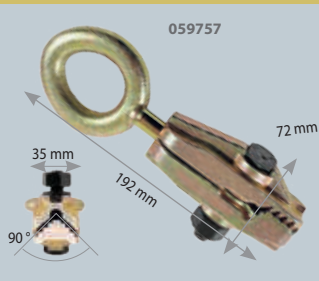

C TYPE CLAMP - Pince de tirage type C

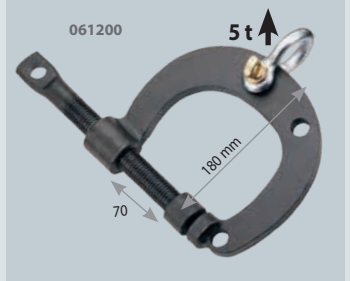

SMART SATELLITE - Satellite intelligent- Satellite Komplett-Kit

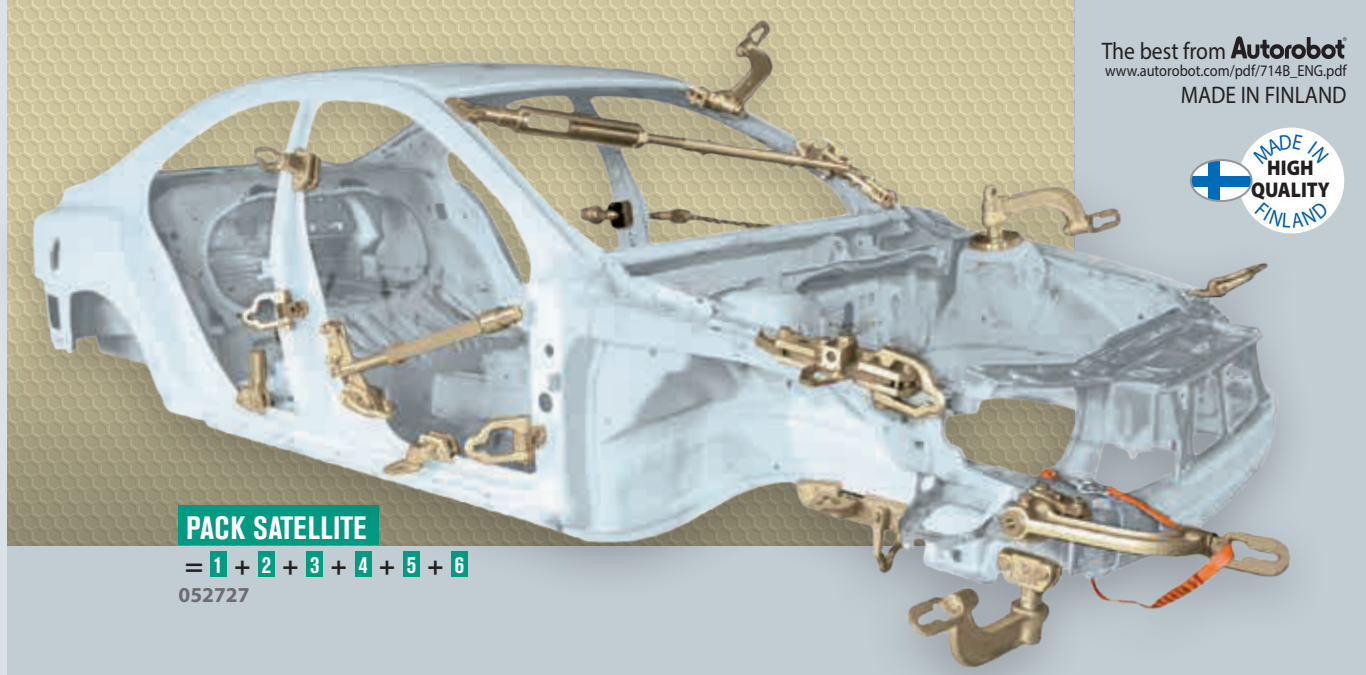

The best from **Autorobot**
www.autorobot.com/pdf/7148_ENG.pdf
MADE IN FINLAND



PACK SATELLITE
= 1 + 2 + 3 + 4 + 5 + 6
052727

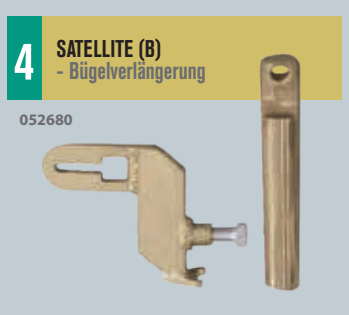
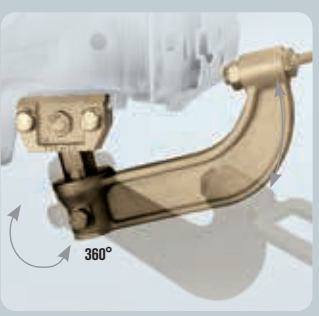

PINCE DE TIRAGE MULTI-USAGE - Versatile pulling clamp - Multifunktions-Zugklemme



WELDING SHEETS KIT WITH CLAMP - Kit plaques à souder et pince



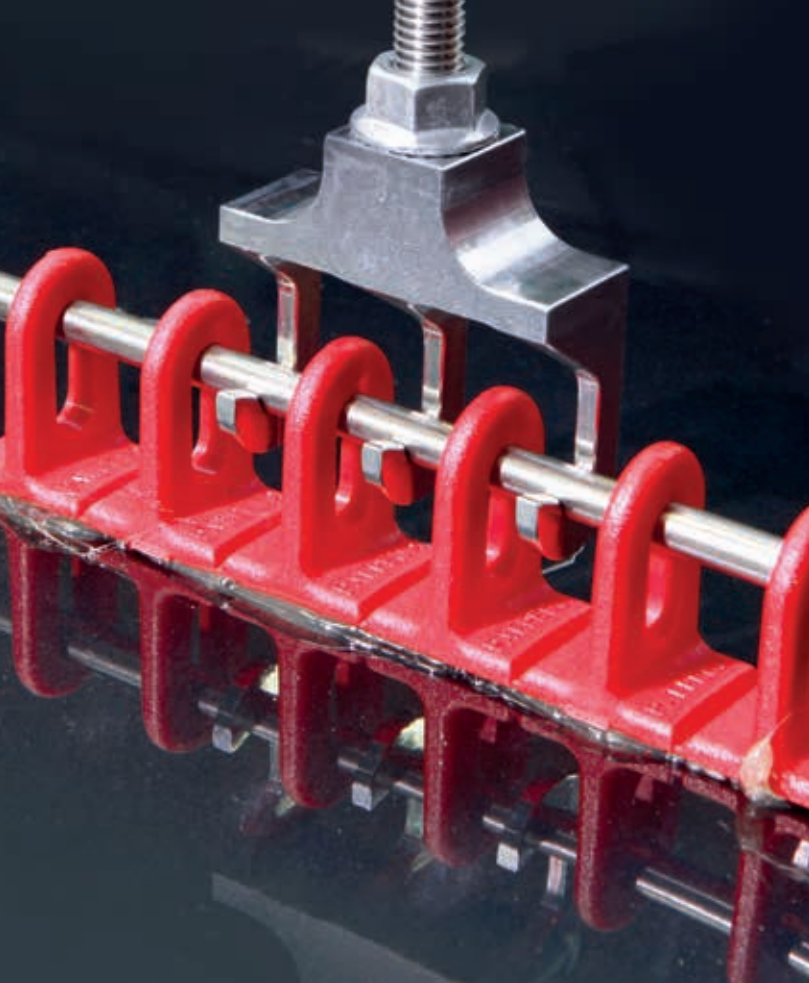

PAINTLESS DENT REPAIR + GLUE PULLING REPAIR

DENT PULLING INDUCTOR

- Inducteur débosselage - Dellenmatrix

GYS
DUCTION
AUTO + Dent pulling
inductor
054776

= GYS
DUCTION AUTO
DENT REPAIR
054981



Youtube



Licensed by
BETAG.Innovation

🔌	🔌	⚡	Freq.	INTEGRATED TECHNOLOGY	❄️	Cable (m)	📦	📏
50 Hz	A	W	kHz	PFC	FV	Liquid Cooling	Inductor	LxWxH cm / kg
230V, 1~	16	2 400	35+120	▪	▪	—	2 2.5	52 x 30 x 37 / 9.4 37 x 21 x 37 / 7.5

DENT PULLING INDUCTOR

- Inspection carrosserie - Ausbeul Induktor

Planche flexible pour inspection de la carrosserie - Ausbeul-Matrix
Ø 800 mm
059122

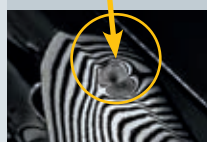

OPTION
Freezer spray
- Spray refroidisseur
-50 °C
400 ml
(x 12)
048898

PAINTLESS DENT REPAIR MAGNETIC KIT

- Kit magnétique de débosselage sans peinture
- Magnetisches Ausbeul-Kit

053168

EXELTOOLS



1010 mm - 40"

705 mm - 28"

610 mm - 24"

510 mm - 20"

DENT PULLING KIT (PAINTLESS)

- Kit débosselage sans peinture - Dellenausbeulhebel-Set

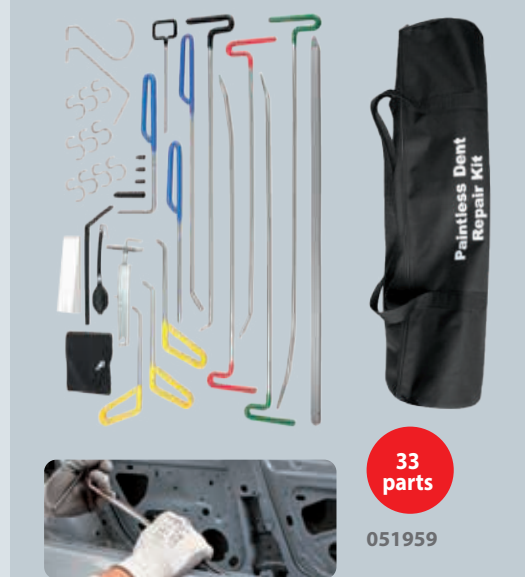

33 parts

051959

AIR CUSHION KIT

- Kit coussins gonflables - Luftpolster-Spreizkissen-Satz



051942

PAINTLESS DENT REPAIR LAMPS

- Lampes de débosselage
- Ausbeullampe

ULTRA LIGHT
CARBON X40 PW
053175

EXELTOOLS

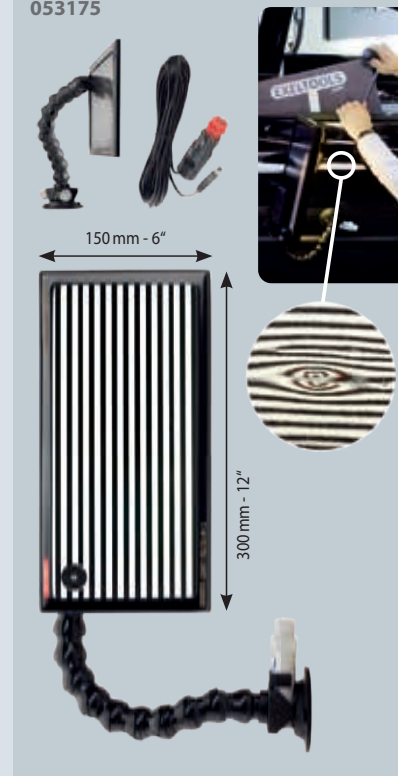

150 mm - 6"

300 mm - 12"

PAINTLESS DENT REPAIR LAMPS

- Lampes de débosselage
- Ausbeullampe

083936

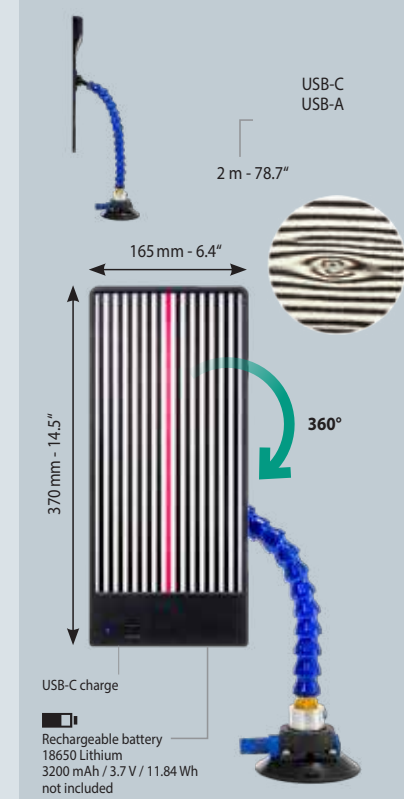

USB-C
USB-A

2 m - 78.7"

165 mm - 6.4"

370 mm - 14.5"

360°

USB-C charge

Rechargeable battery

18650 Lithium

3200 mAh / 3.7 V / 11.84 Wh

not included

SET OF 6 PENCIL PUNCHES

- Kit de 6 coins de frappe - Beulenstemmer-Satz mit 6 Tefloneinsätzen

052888

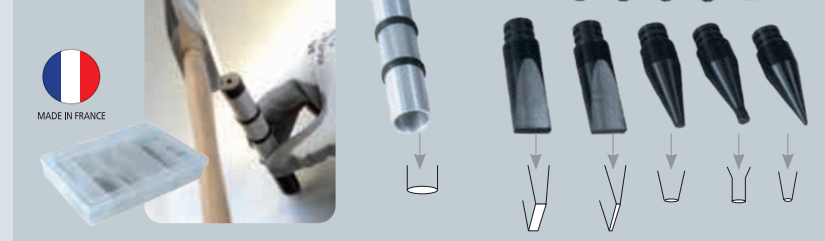

PNEUMATIC INERTIA HAMMER

- Marteau inertie pneumatique - Unterdruck-Schlaghammer

051904



2.5 kg

Ø 60 (x1)

Ø 120 (x1)

Ø 150 (x1)

PUMP AIR SUCTION SLIDE HAMMER

- Marteau à inertie à ventouses (pompage manuel) - Man. Unterdruck-Schlaghammer

1,1 kg

048683



Ø 75 (x1)

Ø 100 (x1)

Ø 125 (x1)



PDR: Paintless Dent Repair
- Débosselage rapide et sans peinture
- Lackschadenfreies Ausbeulen

PAINTLESS DENT REPAIR

GLUE PULLER PRO (Acier/Alu • Steel/Alu)



Glue Puller PRO
058699

Glue Puller PRO
EXPORT
230 V 059160

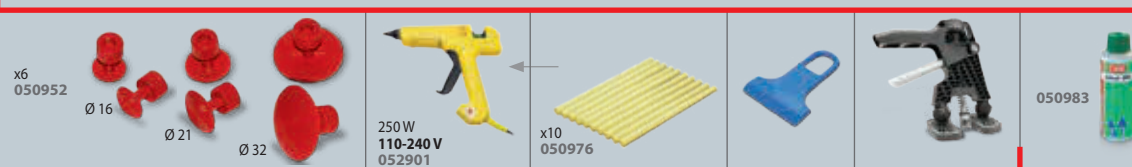

BARRETTES ANNEAUX PLASTIQUE - Plastic Multipads Ösen-Klebepads

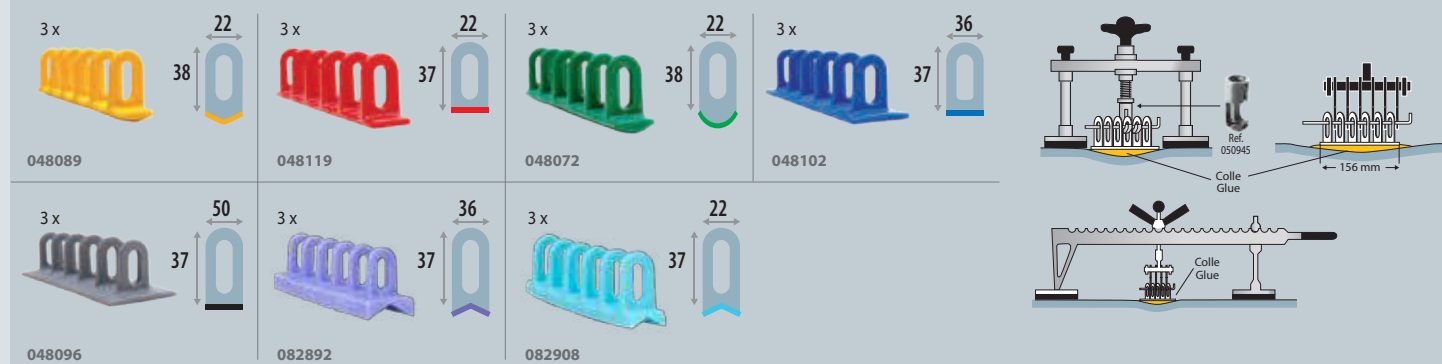

OPTIONS

Pulling handle 3 claws - Poignée de tirage 3 dents - Handzugkralle 3-fach
057326



Slide hammer 380 g
- Marteau à inertie 380 g
- Gleithammer 380 g

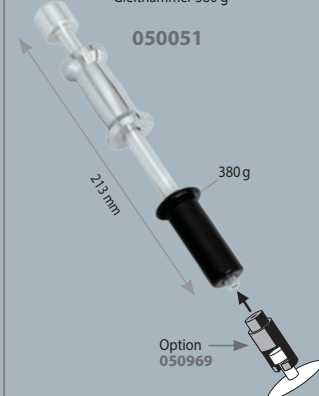

Slide hammer 500 g
- Marteau à inertie 500 g
- Gleithammer 500 g

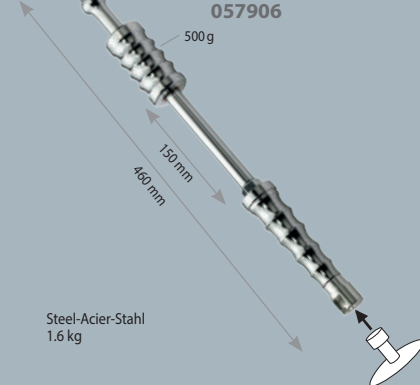

Set of 2 knives to cut glued reinforcements
- Jeu de 2 couteaux pour découpe de renforts colles
- 2-er Set Messer zur Klebepadentfernung



GYSMART GLUE PULLING KIT



GYSMART GLUE PULLING KIT PLUS

Workstation 054233	Set of pencil punches with 6 teflon tips 052888	Infrared thermometer 079922 Heat Gun 066311	Levelling bar 050693 6 Gripping multihook head 049734	3 Lifting rods 150/300/500 mm 050792	Set of 3 conical plastic multipads 048096 048072 048089 048119 048102	Slide hammer 057906	Set of 6 glue tips 050952	Glue Puller PRO 058699	Glue Puller PRO Export 059160	33PC Paintless dent repair kit 051959 PDR Light ultra light carbon X40PW 053175	Mini puller 050921 Aluminium clamp 2 050945
--------------------	---	--	--	--------------------------------------	---	---------------------	---------------------------	------------------------	-------------------------------	--	--

GYSMART GLUE PULLING KIT 076051					✓						
GYSMART GLUE PULLING KIT EXPORT 076105				✓					✓		
GYSMART GLUE PULLING KIT PLUS 076082					✓						✓
GYSMART GLUE PULLING KIT PLUS EXPORT 076129				✓						✓	



GPR: Glue Pulling Repair
- Débosselage par colle
- Lackschadenfreies Ausbeulen

GLUE PULLING REPAIR



GPR I-BAR MINI



080324



GPR FLEXIBLE TABS

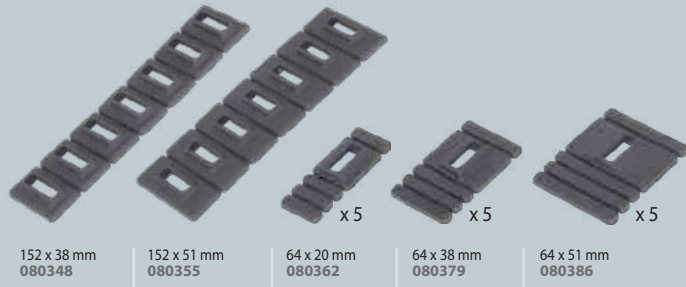

GPR FLAT TABS



GPR 3D TABS



GPR 3D CURVE TABS

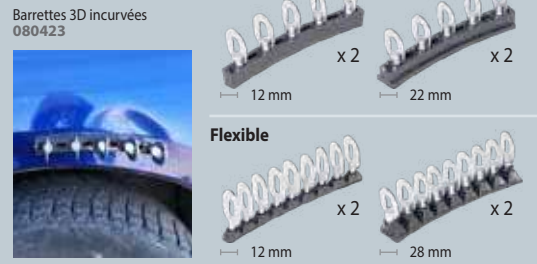

GPR UNIVERSAL TABS

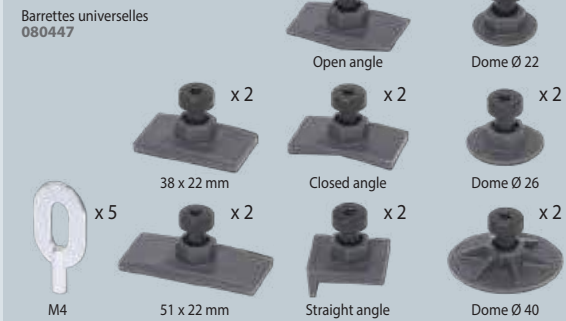

GPR FOLD TABS

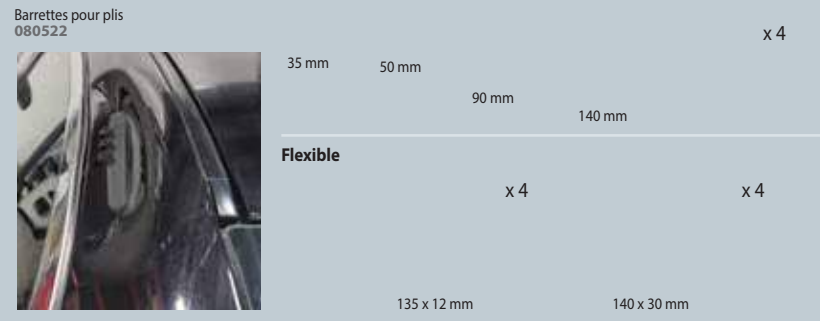

GPR HAIL IMPACT TABS



GPR BAR TABS

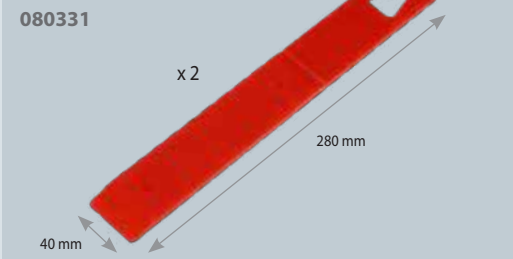

GLUE GUN 400W - Pistolet à colle chaude 400W

082144



GPR Glue sticks
- Bâtons de colle
080454



GPR Glue sticks for stripped sheets
- Bâtons de colle pour tôles découpées
081017

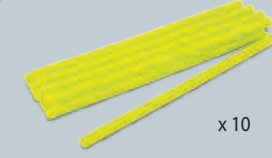

Workstation Premium -
Servante Premium
076143



(p. 136)

GPR PRO KIT

080317



1	GPR I-bar mini	51 mm	x 1
GPR Flexible tabs			
2	64 x 20 mm		x 1
	64 x 38 mm		x 1
	64 x 51 mm		x 1
GPR Long tabs			
3	152 x 38 mm		x 1
	152 x 51 mm		x 1
GPR Plastic hooks			
4			x 10
GPR Bar tab			
5			x 1
GPR 3D tabs			
6	12 mm		x 1
	22 mm		x 1
GPR 3D curved tabs			
7	51 x 38 mm		x 1
	101 x 38 mm		x 1
GPR M4 steel hooks			
8			x 5
GPR Universal tabs			
	Flat 38 x 22 mm		x 1
	Flat 51 x 22 mm		x 1
9	Open angle 38 x 22 mm		x 1
	Closed angle 38 x 22 mm		x 1
	Straight angle 27 x 22 mm		x 1
	Dome Ø 22 mm		x 1
	Dome Ø 26 mm		x 1
	Dome Ø 40 mm		x 1
GPR Flat tabs			
	Ø 13 mm		x 1
	Ø 23 mm		x 1
10	Ø 27 mm		x 1
	Ø 32 mm		x 1
	Ø 38 mm		x 1
	Ø 52 mm		x 1
GPR Bars for folds			
	35 mm		x 1
	50 mm		x 1
	90 mm		x 1
	140 mm		x 1
	Flexible 135 mm		x 1
	140 x 30 mm		x 1
11			x 4
GPR Glue sticks			
12			x 10

Isopropyl alcohol
99.9% + spray - Alcool
isopropyloque 99.9% +
vaporisateur
082236



1 L 600 ml

Heat gun - Décapeur
thermique
066311



Digital display -
Affichage numérique
I: 100/300°C (450 W)
II: 300/650°C (1500 W)
Air flow: 450 l/min

Gas hot air gun
- Pistolet à air chaud
autonome à gaz
060777



Gas included -
Bouteille incluse

Blow torch - Lampe à
souder
052741



Gas not included -
Bouteille non incluse

Novacet +
Butane/Propane/Propylène
040441



380 ml (220 g)

Infrared
thermometer
- Thermomètre infrarouge
079922



Adjustable emissivity:
0.10-1.00

Set of 6 pencil
punches - Kit de 6
coins de frappe
052888



(p. 47)

3 plastic wedges
- 3 cales plastiques
051294



Lifting rod 180 mm
- Tige de tirage 180 mm
082915



Pulling hand 3
claws - Poignée de
tirage 3 dents
057326



4 tooth claw
Ø M10 / M14
049758



Slide hammer 500g
- Marteau à inertie 500g
057906

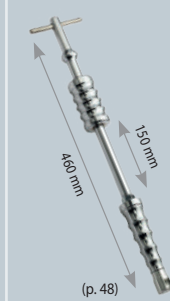

(p. 48)

Slide hammer 1.7kg
- Marteau à inertie 1,7kg
051201

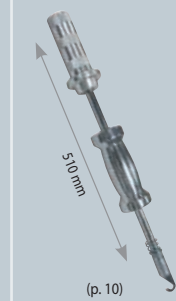

(p. 10)

Glue Lifter
057364



included
061392

(p. 48)

Arc Puller
Premium
065161



included
Alu 3
065161

(p. 19)

Arc Puller
Premium Pro
072572



included
Alu 4
065185

option
Steel M14
079830

(p. 19)

Premium Pro
Levelling bar
900 mm
071643

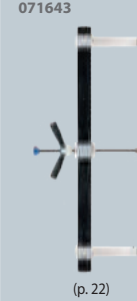

(p. 22)

Airfix Draw Aligner
077379



(p. 39)



RESISTANCE SPOT WELDING

RANGES 54

PRESENT MACHINES

PORTASPOT / 100 R.CX / B.P.LX	56
BP GENIUS	58
PTI-S7 / PTI PREMIUM PRO	60
PTI GENIUS	62

NEW MACHINES WITH COLOUR SCREEN

PTI NEO	64
PTI MASTER / PTI EXPERT	66

ARMS & CONSUMABLES

G ARMS	68
ACCESSORIES & CONSUMABLES	69
X ARMS / C ARMS	70

CAR MANUFACTURER REQUIREMENTS

EXIGENCES CONSTRUCTEUR - ANFORDERUNGEN DES AUTOMOBILHERSTELLERS
- REQUISITI DEL PRODUTTORE DI AUTOMOBILI

An example of new generation car body
• Exemple de carrosserie nouvelle génération
• Beispiel einer Karosserie der neuen Generation
• Esempio di carrozzeria di nuova generazione

- HSS - HLE
- Bore - Boron
- VHSS - THLE
- Aluminium
- UHSS - UHLE



VS RESISTANCE SPOT WELDING - Soudure par résistance

MIG/MAG PLUG WELDING - Bouchonnage MIG/MAG

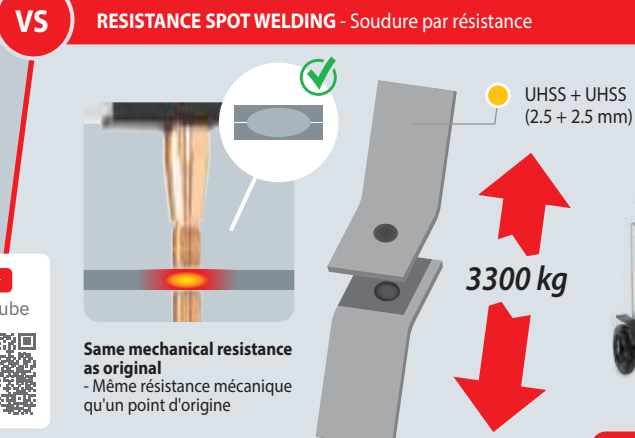
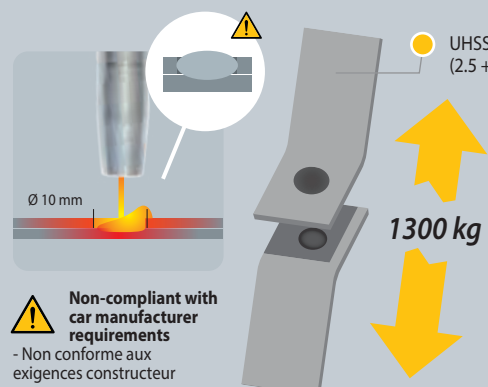

INVERTER machine

MANUFACTURER APPROVALS / COMPLIANCE

HOMOLOGATIONS PRODUITS - PRODUKT HOMOLOGATIONEN - PRODOTTI APPROVATI



	Volkswagen Group	Jeep	Mercedes	smart	Evobus	Jaguar/Land Rover	Ford USA	Honda USA	NIO	LYNK&CO	BVW
DENT PULLER	GYSPT 26.02/27.02	•	•	•	•	•	•	•	•	•	•
	GYSPT 34.02/04, 36.02/04, 39.02/04, PRO230/400, EXPERT 200/230/400	•	•	•	•	•	•	•	•	•	•
	Workstations	•	•	•	•	•	•	•	•	•	•
	GYSPT ALU FV	•	•	•	•	•	•	•	•	•	•
RESISTANCE SPOT WELDER	GYSPT ARCPULL 200	•	•	•	•	•	•	•	•	•	•
	GYSPT BP-LX	•	•	•	•	•	•	•	•	•	•
	GYSPT BP GENIUS	•	•	•	•	•	•	•	•	•	•
	GYSPT PTI-s7	•	•	•	•	•	•	•	•	•	•
	GYSPT PTI PREMIUM PRO	•	•	•	•	•	•	•	•	•	•
	GYSPT PTI GENIUS	•	•	•	•	•	•	•	•	•	•
	GYSPT PTI NEO, MASTER	•	•	•	•	•	•	•	•	•	•
GYSPT PTI EXPERT	•	•	•	•	•	•	•	•	•	•	
VAS 821 101 - Spot Welder	•	•	•	•	•	•	•	•	•	•	
RIVE TING	GYSPRESS	•	•	•	•	•	•	•	•	•	•
	E1 GYS AUTO	•	•	•	•	•	•	•	•	•	•
MIG/MAG	E2, E3 GYS AUTO	•	•	•	•	•	•	•	•	•	•
	P1, P2, P3 GYS AUTO	•	•	•	•	•	•	•	•	•	•
	AUTOPULSE 220-M1	•	•	•	•	•	•	•	•	•	•
	AUTOPULSE 220-M2	•	•	•	•	•	•	•	•	•	•
	AUTOPULSE 220-M3	•	•	•	•	•	•	•	•	•	•
	AUTOPULSE 320-T1	•	•	•	•	•	•	•	•	•	•
	AUTOPULSE 320-T3	•	•	•	•	•	•	•	•	•	•
VAS 821 005 - Pulse MIG	•	•	•	•	•	•	•	•	•	•	
VAS 821 00580 023	•	•	•	•	•	•	•	•	•	•	
PLASMA	EASYCUT 40	•	•	•	•	•	•	•	•	•	•
	CUTTER K25, K35	•	•	•	•	•	•	•	•	•	•
	EASYCUT 30FV, CUTTER 45CT	•	•	•	•	•	•	•	•	•	•
	GYSDUCTION AUTO	•	•	•	•	•	•	•	•	•	•

Homologated by car manufacturers | Meets the specifications of car manufacturers



Monochrome Screen Generation



	PTI s-7	BP GENIUS	PTI PREMIUM PRO	PTI GENIUS
Machine type - Type de machine	Transformer inside	Cable	Transformer inside	Transformer inside
Arm - Bras	C	G	G	G
Max welding current - Courant de soudage max	14500 A	13000 A	14500 A	14500 A
Max tightening force - Effort de serrage max	550 daN	550 daN	550 daN	550 daN
Clamp weight - Poids de la pince	9.9 kg	6.5 kg	10.3 kg	11.3 kg
Electrode with over-opening - Electrode avec sur-ouverture	—	Pneumatic	—	Pneumatic
Welding max frequency - Cadence max de soudage	10 pts/min	20 pts/min	10 pts/min	20 pts/min
Automatique mode - Mode automatique	•	•	•	•
Cooling system - Système de refroidissement	30 litres	30 litres	30 litres	30 litres
Duty cycle - Facteur de marche	★★★★	★★★★	★★★★	★★★★★
Clamp cable length - Longueur faisceau pince	4 m or 6 m	2.5 m	6 m	6 m
Gyro - Gyro	(Option)	• Ball bearing Gyro	•	• Ball bearing Gyro
Mains cable length - Longueur câble secteur	8 m	8 m	8 m	8 m
Balancing arm - Avec potence	•	•	•	• Electric, adjustable height
Disconnectable clamp - Pince déconnectable	•	—	•	—
Single sided gun - Pistolet monopoint	(Option)	•	(Option)	(Option)
Software update - Mise à jour logicielle	SD card	SD card	SD card	SD card

3.5" Colour Screen Generation



	PTI NEO	PTI MASTER	PTI EXPERT
Machine type - Type de machine	Transformer inside	Transformer inside	Transformer inside
Arm - Bras	G	G	G
Max welding current - Courant de soudage max	13000 A	13000 A	14500 A
Max tightening force - Effort de serrage max	550 daN	550 daN	550 daN
Clamp weight - Poids de la pince	9.7 kg	10.3 kg	11.8 kg
Electrode with over-opening - Electrode avec sur-ouverture	—	Mechanical	Mechanical
Welding max frequency - Cadence max de soudage	10 pts/min	10 pts/min	10 pts/min
Automatique mode - Mode automatique	•	•	•
Cooling system - Système de refroidissement	5 litres	5 litres	30 litres
Duty cycle - Facteur de marche	★★★	★★★	★★★★★
Clamp cable length - Longueur faisceau pince	4 m	4 m	5 m
Gyro - Gyro	—	—	•
Mains cable length - Longueur câble secteur	8 m	8 m	8 m
Balancing arm - Avec potence	—	—	•
Disconnectable clamp - Pince déconnectable	—	—	•
Single sided gun - Pistolet monopoint	(Option)	(Option)	(Option)
Software update - Mise à jour logicielle	USB	USB	USB

RESISTANCE SPOT WELDING RANGES



PORTASPOT / GYSPOT

RESISTANCE SPOT WELDING

PORTASPOT 230

6 300 A 120daN

Air cooled

230V
022256

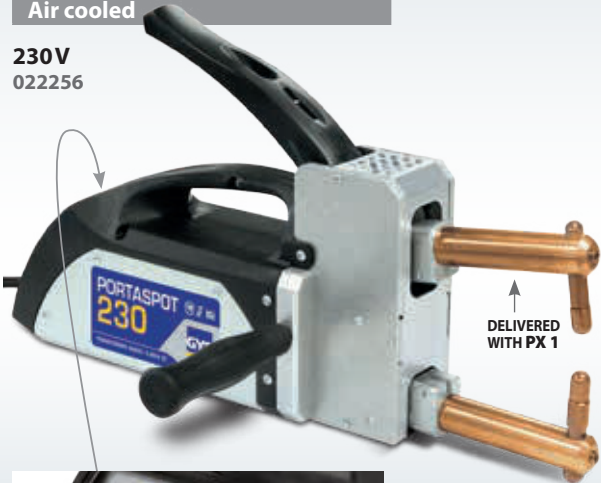

DELIVERED WITH PX 1



ARMS Ø 23 mm

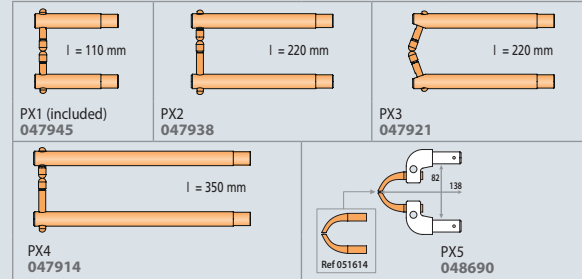

ELECTRODES



CAPS & ACCESSORIES

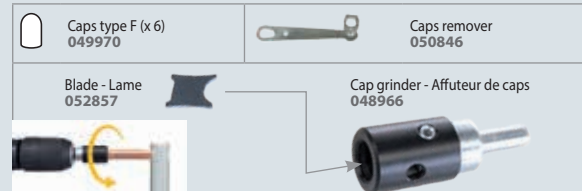

50/60 Hz	A	A	A	mm	V	m	mm ²	LxWxH cm / kg
1 x 230V	16(D)	6 300	8 900	2+2	2.45	2.5	3x2.5 H05VVf	OK 41 x 18 x 22 / 11.3

GYSPOT 100R-CX

10 000 A 550 daN (X) 350 daN (C)

For mild steel, HSS, UHSS

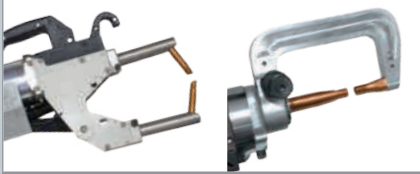

Air cooled

Traceability software Save spot welding configuration and export data



3 x 400V
022317



OPTIONS 100R-CX

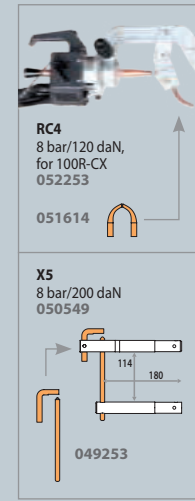

included	
Monopoint/Spot 049291	▪
Inertia hammer 049482 + 049802	▪
Spotter box pro 050075	▪
Top support box	▪
Contact grease 050440	▪
Caps remover 050846	▪
Cable support	× 2
RX1 051034	▪
RX3 051058	▪
RC1 051065	▪
RC2 051072	▪
RC3 051089	▪

OPTIONS

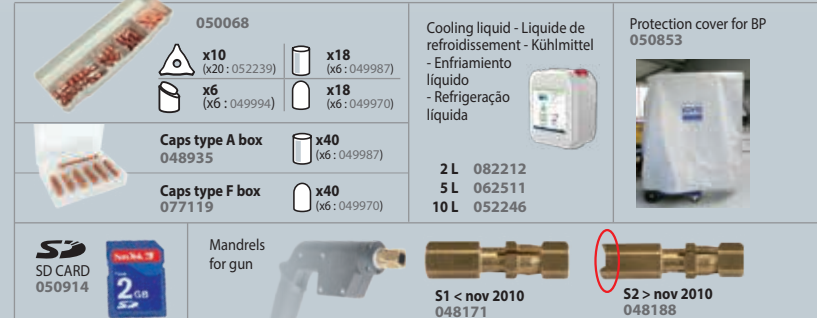

GYSPOT BP-LX

13 000 A 550 daN

For mild steel, HSS, UHSS Boron steel



Liquid cooled

BP BODYPROTECT Unique electro-magnetic field protection 2013/35/UE by GYS

Traceability software Save spot welding configuration and export data



019652

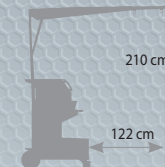

	019652	058804
Gyspot BP-LX	400V	
Monopoint/Spot 049291	▪	▪
Spotter box pro (p.10) 050075	▪	▪
Inertia hammer 049482 + 049802	▪	▪
X1 050501	▪	▪
X4A (x2) + X4B + X4C + X2 020733	▪	▪
Liquid cooling (10l) 052246		(x3)

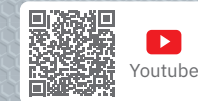

MADE IN FRANCE 62135	50/60 Hz	A D curve	Spots/min (max) 2.5+2.5	RMS A	mm		Uo V	Cables				100% CU	LxWxH cm / kg
					↕	↔		↔	↔	↔	↔		
GYSPOT 100R.CX	3 x 400V	32 (22 kVA) 40 (28 kVA) 50 (35 kVA)	2 6 10	10 000	2.5+2.5+2.5	1.5+3	16	2.5 m, air Ø 200 mm ²	2.5 m, air Ø 200 mm ²	2.5 m, air Ø 150 mm ²	8 m, 4 x 6 H07RNF	OK	61 x 79 x 71 / 137
GYSPOT BPLX	3 x 400V	32 (22 kVA) 40 (28 kVA) 50 (35 kVA)	2 6 10	13 000	2.5+2.5+2.5	1.5+3	16	2.5 m, liquid	—	2.5 m, air	8 m, 4 x 6 H07RNF	OK	65 x 80 x 205 / 164.5



GYSPOT

RESITANCE SPOT WELDING BP GENIUS

G
ARMS



MADE IN FRANCE

G-clamp front
body + protection
078765

**ULTRA LIGHT
& COMPACT**
6.5 kg
(Gyro & G1 included)

550 daN

LIQUID COOLED
REFROIDISSEMENT
LIQUIDE
Ø 10 mm

6.5 kg
(Gyro & G1 included)



Youtube

OPTIONS

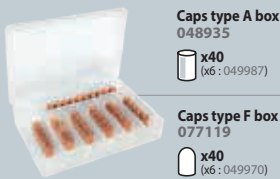

Caps type A box
048935
x40 (x6: 049987)
Caps type F box
077119
x40 (x6: 049970)

x20 (x6: 049987)
x6 (x6: 049970)
x2 (x1: 050617)
073449



Cooling liquid - Liquide
de refroidissement
- Kühlmittel
- Enfrimiento líquido
- Refrigeração líquida

2L 082212
5L 062511
10L 052246



Protection
cover
- Housse de
protection
- Schutzhaube
for BP & PTI
050853



10-14 kg
059696

FAST OPEN XL

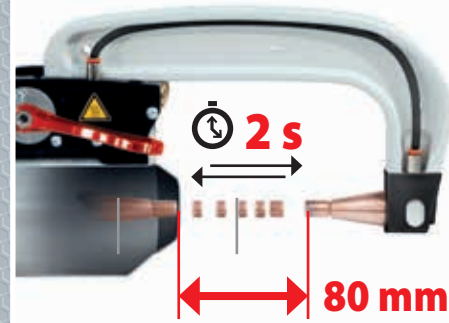

EASY



GYRO INTEGRATED

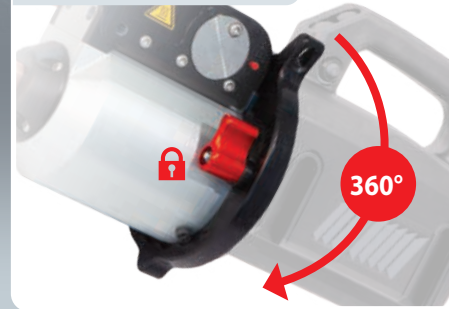

PERFECT ELECTRICAL CONNECTION



AUTO

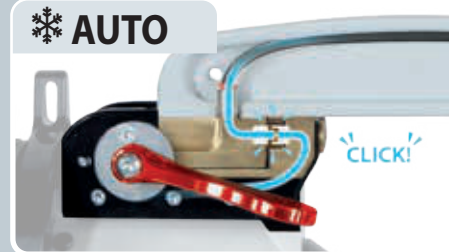

GYSPOT BP GENIUS

13 000 A
550 daN

For mild steel, HSS, UHSS Boron steel

BP BODYPROTECT
Unique electro-magnetic field protection
by GYS

Traceability software
Save spot welding configuration
and export data



	023550	023451	082250
Gyspot BP GENIUS	220V	400V	
Monopoint/Spot 049291	▪	▪	▪
Spotter box pro (p.10) 050075	▪	▪	▪
Inertia hammer 049482 + 049802	▪	▪	▪
Caps remover 050846	▪	▪	▪
Arm support	▪	▪	▪
G1 022768	▪	▪	▪
G2 + G3 + G4 022898	▪	▪	▪
Liquid cooling (10L) 052246	▪	▪	(x3)
Caps type A box 048935	▪	▪	▪
Protection cover 050853	▪	▪	▪



59

GYSPOT BP GENIUS

LIQUID COOLED

MADE IN FRANCE 62135	50/60 Hz	RMS A	-AM- A D curve	Spots max 2.5+2.5 mm	Uo V	mm					Cables			100 % CU	cm	kg
						↕	↔	↗	↘	↖	↙	↘	↙			
GYSPOT BP GENIUS 400V	3 x 400V	13 000	32 (22 kVA) 40 (28 kVA) 50 (35 kVA)	2 6 10	16	2.5+2.5+2.5	1.5+3	2.5 m, Ø 200 mm ² , Liquid	2.5 m, Ø 150 mm ² air	8 m 4x6 mm ² H07RN-F	OK	65 x 80 x 205	171			
GYSPOT BP GENIUS 220V	3 x 200V 208 V 230 V 240 V	10 500 11 000 12 000 12 500	60 (21-25 kVA) 80 (28-33 kVA) 100 (35-41 kVA)	2 6 10	15 15.5 17 18	2.5+2.5+2.5	1.5+3	2.5 m, Ø 200 mm ² , Liquid	2.5 m, Ø 150 mm ² air	8 m 4x6AWG (500V)	OK	65 x 80 x 205	178			



GYSPOT

RESISTANCE SPOT WELDING

GYSPOT PTI-s7

14 500 A
550 daN

For mild steel, HSS, UHSS Boron steel



FUSE 20 A
Double pressure
Ø 10 mm
9.9 kg (included C1)

TRANSFORMER INSIDE

Liquid cooled

Traceability software
Save spot welding configuration and export data

Convert PTI S-7 to Premium Pro
C ARMS G ARMS

Kit Renov PTI Premium Pro

220V
072367



400V
072541

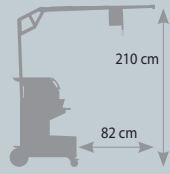

C ARMS



9.9 kg

	220V	400V	
Gyspot PTI-s7	6M 022195	4M 020894	4M 067998
Contact grease 050440	▪	▪	▪
Caps remover 050846	▪	▪	▪
Arm panel	▪	▪	▪
C1 021402	▪	▪	▪
C2 + C3 + C4 060821	▪	▪	▪
C6 022409	▪	▪	▪
Gyro 360° 051720	▪	▪	▪
Complete gun kit 067318	▪	▪	▪
Liquid cooling (10L) 052246	▪	▪	(x3)

OPTIONS

GYRO 360° for PTI S-7 051720

Kit gun for PTI S-7 067318

200 mm² 1.6 m

300 mm² 1 m

Cooling liquid - Liquide de refroidissement
- Kühlmittel
- Enfriamiento líquido
- Refrigeração líquida

2 L 082212
5 L 062511
10 L 052246

Protection cover - Housses de protection - Schutzhaube
for BP & PTI 050853

10-14 kg 059696

MADE IN FRANCE 62135	50/60 Hz	RMS A	-AM- A D curve	Spots/min (max)	U _o		mm		Cables			cm	kg
					V	mm	mm	mm	mm	mm			
GYSPOT PTI-s7	3 x 400 V	14 500	20 (14 kVA)	10	7.3	2.5+2.5+2.5	1.5 + 3	4 m, liquid or 6 m, liquid	OPTION 067318 : 1.6 m, Ø 200 mm ²	8 m, 4x4 mm ² H07RNF	65 x 80 x 230	105.3	
GYSPOT PTI-s7 220 V	3 x	200 V 12 500	208 V 13 000	40 (14-16 kVA)	10	6.5	2.5+2.5+2.5	1.5 + 3	4 m, liquid or 6 m, liquid	OPTION 067318 : 1.6 m, Ø 200 mm ²	8 m, 4xAWG8 (500W)	65 x 80 x 230	115.7
230 V 14 500		7.4											
240 V 14 500		7.7											

GYSPOT PTI PREMIUM PRO

14500 A
550 daN

For mild steel, HSS, UHSS Boron steel



FUSE 25 A
Double pressure
Ø 10 mm
10.3 kg (included G1)

TRANSFORMER INSIDE

Liquid cooled

Traceability software
Save spot welding configuration and export data

GYRO INCLUDED



PERFECT ELECTRICAL CONNECTION

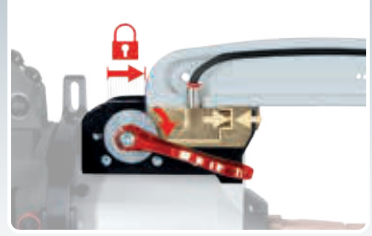

AUTO

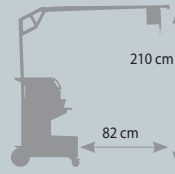

G ARMS



10.3 kg

	220V	400V	
Gyspot PTI Premium Pro	6M 072206	6M 072183	6M 082243
Caps remover 050846	▪	▪	▪
Arm panel	▪	▪	▪
G1 022768	▪	▪	▪
G2 + G3 + G4 022898	▪	▪	▪
Liquid cooling (10L) 052246	▪	▪	(x3)
Caps type A box 048935	▪	▪	▪
Protection cover 050853	▪	▪	▪

OPTIONS

Kit gun for PTI Premium Pro 067226

300 mm² 1.8 m

300 mm² 1 m

G11 for PTI Premium Pro 071766

25 mm max

120 mm

MADE IN FRANCE 62135	50/60 Hz	RMS A	-AM- A D curve	Spots/min (max)	U _o		mm		Cables			cm	kg
					V	mm	mm	mm	mm	mm			
GYSPOT PTI PREMIUM PRO 400V	3 x 400 V	14 500	25 (14 kVA)	10	7.4	2.5+2.0+2.0	1.5 + 3.0	6 m, liquid	OPTION 067226 : 1.8 m, Ø 300 mm ²	8 m, 4x4 mm ² H07RNF	65 x 100 x 230	109	
GYSPOT PTI PREMIUM PRO 220V	3 x	200 V 12 500	50 (17-21 kVA)	10	6.5	2.5+2.0+2.0	1.5 + 3.0	6 m, liquid	OPTION 067226 : 1.8 m, Ø 300 mm ²	8 m, 4xAWG8 (500W)	65 x 100 x 230	119	
208 V 13 000		7.4											
230 V 14 500		7.7											





GYSPOT

RESISTANCE SPOT WELDING PTI GENIUS



MADE IN FRANCE

550 daN

LIQUID COOLED
REFROIDISSEMENT
LIQUIDE
Ø 10 mm

11.3 kg
(Gyro & G1 included)

G
ARMS

G-clamp front
body + protection
078765

FAST OPEN XL

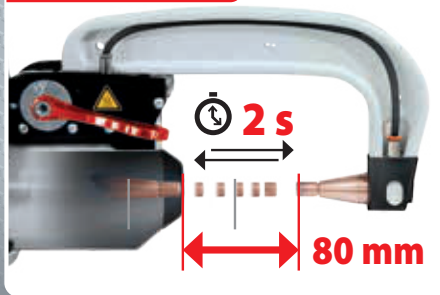

GYRO INTEGRATED

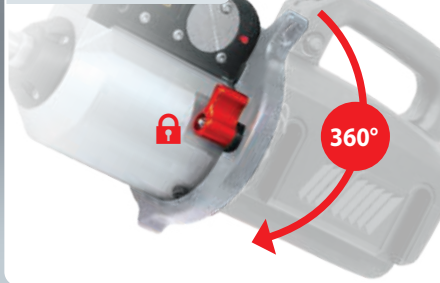

PERFECT ELECTRICAL CONNECTION

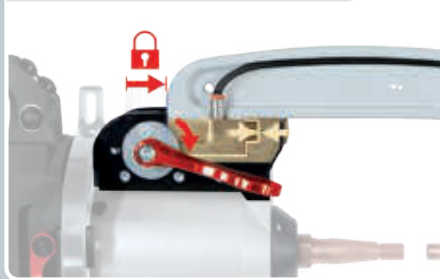

AUTO

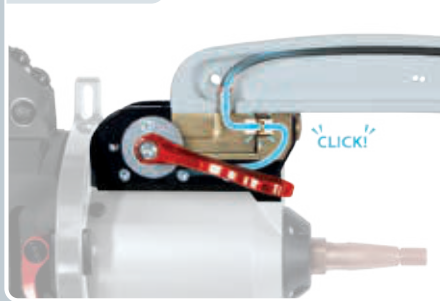

TRANSFORMER INSIDE

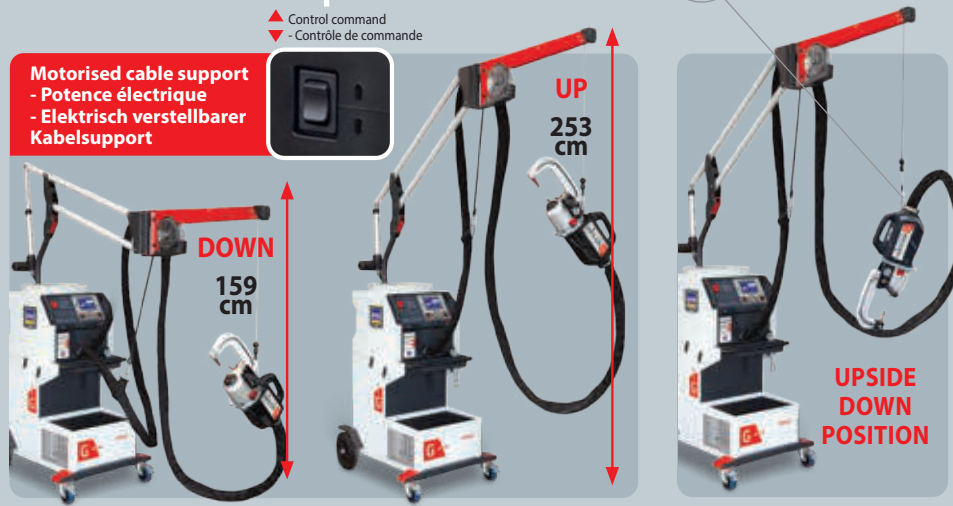

Motorised cable support
- Potence électrique
- Elektrisch verstellbarer
Kabelsupport

Control command
- Contrôle de commande

OPTIONS

Caps type A box 048935 x40 (x6: 049987)	Caps type F box 077119 x40 (x6: 049970)	SD CARD 050914	Kit WIFI Compatibility: Gyspot Inverter PTI-GENIUS 070691	Cooling liquid 2L 082212 5L 062511 10L 052246	for PTI GENIUS 077126

GYSPOT PTI GENIUS

14 500 A
550 daN

For mild steel, HSS, UHSS Boron steel

TRANSFORMER INSIDE

Liquid cooled

Traceability software
Save spot welding configuration
and export data

	024878	082267	024854	024892
	400V		220V	480V
Gyspot PTI-GENIUS				
Caps remover 050846				
Arm support				
G1 022768				
G2 + G3 + G4 022898				
Liquid cooling (10L) 052246		(x3)		
Caps type A box 048935				
Protection cover 077126				

Ergonomic

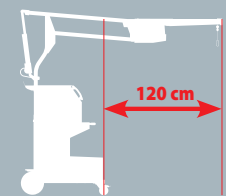

Included
Cable support
ULTRA
RESISTANT



ELECTRIC
MOTOR

Control
Commande

Electrode storage
- Rangement pour
électrodes

6 m

High stability -
Grande stabilité

OPTIONS

Kit gun
067226

300 mm²
1.8 m

300 mm²
1m

MADE IN FRANCE 62135	RMS A	SPT A D curve	Spots/min (max)	U _o		mm		Cables		cm	kg		
				V	mm	mm	mm	mm					
GYSPOT PTI GENIUS 400V	3 x 400V	14 500	25 (17 kVA)	20	7	2.5+2.5+2.5	1.5+3	6 m, Liquid	8 m 4x4 mm ² H07RN-F	71 x 90 x 200	127.7		
												200	12 500
												208	13 000
												230	14 500
GYSPOT PTI GENIUS 220 V	3 x 230V	14 500	50 (17-21 kVA)	20	7.3	2.5+2.5+2.5	1.5+3	6 m, Liquid	8 m 4xAWG8 (500W)	71 x 90 x 200	136.2		
												240	14 500
												7.9	
GYSPOT PTI GENIUS 480V	3 x 480V	14 500	20 (17 kVA)	20	7	2.5+2.5+2.5	1.5+3	6 m, Liquid	8 m 4xAWG12 (500W)	71 x 90 x 200	128.7		

GYSPOT PTI GENIUS

LIQUID COOLED



RESISTANCE SPOT WELDING PTI NEO

NEW



MADE IN FRANCE

Manual Mode

Direct entry of welding current, time and pressure -
Entrée directe du courant et temps de soudage et de la pression

3.5" colour screen
Easy navigation interface



Automatic Mode

Automatic detection of the welding parameters
- Détection automatique des paramètres de soudage



Synergic Mode

User defined welding parameters
- Programmation par l'utilisateur



Car Manufacturer Mode

Specific Car Manufacturer pre-programmed welding parameters
- Points de soudure constructeur préprogrammés



Traceability software
Save spot welding configuration and export data



G ARMS

EASY OPENING

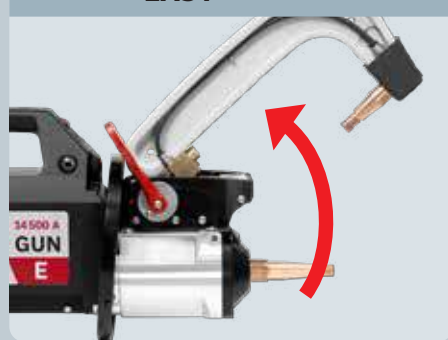

PERFECT ELECTRICAL CONNECTION



AUTOMATIC HYDRAULIC CONNECTION



OPTIONS

<p>Caps type A box 048935 x40 (x6: 049987)</p> <p>Caps type F box 077119 x40 (x6: 049970)</p>	<p>x20 (x6: 049987)</p> <p>x6 (x6: 049970)</p> <p>x2 (x1: 050617)</p> <p>073449</p>	<p>EASY USB UPDATE</p> <p>USB key 16 Gb 062344</p>	<p>Cooling liquid - Liquide de refroidissement - Kühlmittel - Enfriamento líquido - Refrigeração líquida</p> <p>2L 082212 5L 062511 10L 052246</p>	<p>Protection cover - Housse de protection - Schutzhaube</p> <p>062733</p>
---	---	---	--	--

GYSPOT PTI NEO

13000 A
550 daN

For mild steel, HSS, UHSS Boron steel

TRANSFORMER INSIDE

Liquid cooled : 5 litres

Automatic Mode

Automatic detection of the welding parameters

3.5" colour screen

Easy navigation interface

Traceability software

Save spot welding configuration and export data

	024779	084834	077362	084841
Gyspot PTI-NEO	400V		208-240V	
Caps remover 050846	■	■	■	■
G1 022768	■	■	■	■
G2 + G4	■	■	■	■
	ALL IN 1 BOX	ALL IN 1 BOX	ALL IN 1 BOX	ALL IN 1 BOX

78.5 x 58.5 x 64 cm 6 units/palette

G arms storage



G1, G2, G3 storage

OPTION

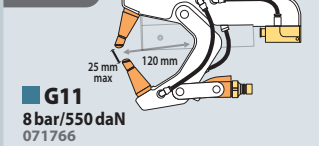

G11 8 bar/550 daN 071766

G ARMS



9.7 kg
VERY LIGHT

OPTION

QUICK FIX Single sided gun
- Kit Pistolet monopoint 082823



EASY CONNECTION



HSS ✓
UHSS ✓
Boron ✓

NEW 05/2024

LIGHT TROLLEY

4 m

LIQUID COOLING
5 Litres

MADE IN FRANCE CE NORX 62135	50/60 Hz	RMS A	TAM A D curve	Spots/min (max)	Uo V	mm		Cables				cm	kg		
						mm	mm	(option)	(option)	(option)	(option)				
GYSPOT PTI NEO 400V	3 x 400V	13 000	20	10	7.7	2.5+2.0+2.0	1.5+3.0	4 m, Liquid	1.8 m, Ø 300 mm ²	1 m, Ø 300 mm ²	8 m 4x4 mm ² HOT8NF	63 x 76 x 127	57		
														200V	10 900
														208V	11 300
														230V	12 500
GYSPOT PTI NEO 208-240V	3 x	30	10	10	7.7	2.5+2.0+2.0	1.5+3.0	4 m, Liquid	1.8 m, Ø 300 mm ²	1 m, Ø 300 mm ²	8 m 4xAWG8 (SOOW)	63 x 76 x 127	62		
														240V	13 000



GYSPOT

RESISTANCE SPOT WELDING

PTI MASTER PTI EXPERT



MADE IN FRANCE

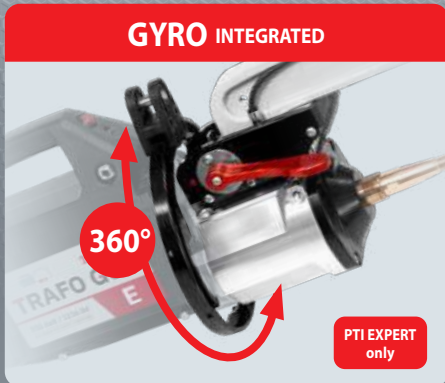
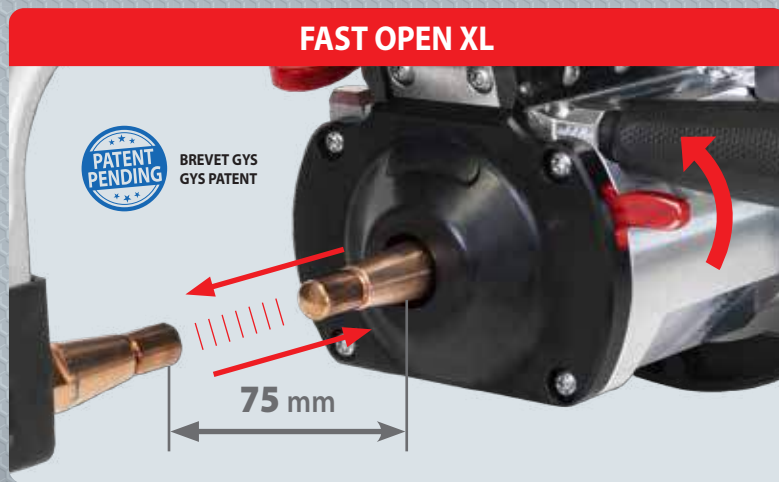

TRANSFORMER INSIDE

MASTER 10.3 kg
(G1 included)

EXPERT 11.8 kg
(Gyro + G1 included)

LIQUID COOLED
Refrroidissement liquide

- TRANSFORMER INSIDE**
- For mild steel, HSS, UHSS
- Boron steel
- Automatic Mode
- 3.5" colour screen
- Traceability software

GYSPOT PTI MASTER

13000 A

550 daN

Liquid cooled : 5 litres

GYSPOT PTI EXPERT

14500 A

550 daN

Liquid cooled : 30 litres

GYSPOT PTI MASTER 400V

13 000 A 400 V • 3 phase

083264

GYSPOT PTI EXPERT 400V

14 500 A 400 V • 3 phase

083943

GYSPOT PTI MASTER 208-240V

13 000 A 208-240 V • 3 phase

083257

GYSPOT PTI EXPERT 208-240V

14 500 A 208-240 V • 3 phase

083950



OPTIONS

- G-clamp front body + protection 078765
- QUICK FIX Single sided gun** - Kit Pistolet monopoint 082823
- EASY CONNECTION**
- Cooling liquid - Liquide de refroidissement - Kühlmittel - Enfriamento líquido - Refrigeração líquida
 - 2L 082212
 - 5L 062511
 - 10L 052246
- Protection cover for PTI MASTER 062733
- Protection cover for PTI EXPERT 050853
- 10-14 kg 059696

MADE IN FRANCE	50/60 Hz	RMS A	A D curve	Spots/min (max)	Uo V	mm		Cables				cm	kg
						mm	mm	(option)	(option)	(option)	(option)		
GYSPOT PTI MASTER 400V	3 x 400 V	13 000	20	10	7.7	2.5+2.0+2.0	1.5 + 3.0	4 m, Liquid	1.8 m, Ø 300 mm ²	1 m, Ø 300 mm ²	8 m, 4x4 mm ² H07RNF	63 x 76 x 127	58
GYSPOT PTI MASTER 208-240V	3 x	200 V	10 900	30	10	2.5+2.0+2.0	1.5 + 3.0	4 m, Liquid	1.8 m, Ø 300 mm ²	1 m, Ø 300 mm ²	8 m, 4xAWG8 (500V)	63 x 76 x 127	63
		208 V	11 300										
		230 V	12 500										
		240 V	13 000										
GYSPOT PTI EXPERT 400V	3 x 400 V	14 500	25	10	7.4	2.5+2.0+2.0	1.5 + 3.0	5 m, Liquid	1.8 m, Ø 300 mm ²	1 m, Ø 300 mm ²	8 m, 4x4 mm ² H07RNF	65 x 100 x 230	109
GYSPOT PTI EXPERT 208-240V	3 x	200 V	12 500	50	10	2.5+2.0+2.0	1.5 + 3.0	5 m, Liquid	1.8 m, Ø 300 mm ²	1 m, Ø 300 mm ²	8 m, 4xAWG8 (500V)	65 x 100 x 230	119
		208 V	13 000										
		230 V	14 500										
		240 V	14 500										



FOR GYSPOT BP GENIUS, PTI PREMIUM PRO & PTI GENIUS

G Arms - Caps Ø13 mm

Bras isolés - Isolated arms - Isolierte Bügel

G2 8 bar/300 daN 022775

G6 8 bar/550 daN 022812

G7 4 bar/150 daN 022829

G11 8 bar/550 daN 022768
for PTI PREMIUM PRO, NEO, MASTER & EXPERT 071766

Kit de maintenance connecteurs pince G - Connectors maintenance kit for G clamp 067295

G arms protections 067288

G4 8 bar/550 daN 022799
Option for G4

G5 8 bar/550 daN 022805
Option for G5

G8 8 bar/550 daN 022836
Option for G8

G1 8 bar/550 daN 022768
Option for G1 & G3

G3 8 bar/550 daN 022782
Option for G3

G14 8 bar/550 daN 080942

G4-SA (Small Access) 064478
(for arms < 01/2021)

G5/G10-SA (Small Access) 067660

G8-SA (Small Access) 067677

G1/G3-SA (Small Access) 067653
(for arms > 02/2021)

G10 8 bar/400 daN 067165
Option for G10 & G12

G12 8 bar/300 daN 075238

G5/G10/G12-SA (Small Access) 067660

G X UNIQUE SYSTEM

BREVETÉ / PATENTED n° US 11,618,097

AUTOMATIC WELDING FOR X1, X2 & X6

Youtube

G9 | 8 bar/550 daN not for PTI PREMIUM PRO

G9 with X1 Included 022881

X1 050501 550 daN

X2 050518 300 daN

G9 with X6 Included 072275

X6 050587 300 daN

Option SD card 050914

Option PCB 97449C

G ARMS PANELS

G2 + G3 + G4 022898

G2 + G3 + G5 063297

KIT SMALL ACCESS GENIUS for PTI GENIUS 077072

included SA 073579

+ G1/G3-SA (Small Access) 134

+ G4-SA (Small Access) 156

+ G5/G10/G12-SA (Small Access) 220

+ G8-SA (Small Access) 368

X/C/G CONSUMABLES - Consommables X/C/G

Type A Cor X clamp Ø 13 mm (x6) 049987

Type B Cor X clamp Ø 13 mm / Ø 5 mm (x6) 055506

Type D Cor X clamp Ø 13 mm (x10) 058507

TYPE F For single sided gun Ø 13 mm (x6) 049970

TYPE G Ø 13 mm (x10) 059672

Caps inclinés - Beveled X2, X4C11 arms Ø 13 mm (x6) 049994

Caps type A box 048935 x40

Caps type F box 077119 x40

Contact grease Graise contact 050440

Caps remover 050846

Anti-corrosion welding primer - Primaire de soudage anti-corrosion 076822

Spot / Monopoint 049291

073449 x20

050068 x10

CAP GRINDER - Affuteur de caps

Lame-Blade 052857

048966

Optimal speed: 400-800 rpm

Youtube

GYRO 360°

for PTI 051720

STEEL SHEET TRACTION BENCH

- Banc de traction arrache tôle - Blech-Zugbank zur Festigkeitsprüfung

052420

052321 (included)

WELD TEST KIT - Valise test soudure HLE / THLE

- Schweißtestkit im Hartschalenkoffer

050433

Barre d'arrache / Traction bar + Acier doux / Mild steel 0.65 (x25) + 1.0 (x25) + Acier HSLA 360 - HLE 0.8 (x25) + 1.5 (x25) + Acier DP600 - THLE/UHLE 1.0 (x25) + Acier FB560 - THLE/UHLE 2.5 (x25)

ANTI-ARC PROTECTION 12V

- Protection anti-arc 12 V - Lichtbogenschutz 12V - Protección anti-arco 12V

041318

PROTECTION COVER

- Housses de protection - Schutzhaube

for BP & PTI 050853

for PTI GENIUS 077126

SHEETS SET

- Échantillons de tôles

Acier standard / Standard steel 0.8 (x65) + 1 (x55) + 1.5 (x35) + 2 (x25) + Alu 1 (x45) + 1.5 (x30) + 2 (x20) 055841

ELECTRODE FORCE SENSOR

- Capteur d'effort

052314

TANK DRAINING KIT - Kit de purge réservoir - Kit zur Tankentleerung

058286

for GYSPOT PTI-s7

SD MEMORY CARD

- Carte mémoire SD

SD CARD 050914

KIT WIFI

for Gyspot Inverter PTI GENIUS 070691

COOLING LIQUID

- Liquide de refroidissement - Kühlmittel - Enfriamiento líquido - Refrigeração líquida

2L 082212

5L 062511

10L 052246

FOR GYSPOT 32D-X, 100R-CX, BP-LX**550 daN****6,5 kg** including X1

- DOUBLE PRESSURE
- LIQUID COOLED / REFRIGÉRISSÉMENT LIQUIDE
- Ø 10 mm

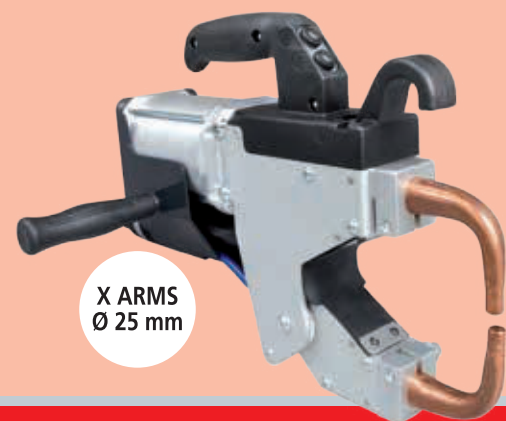
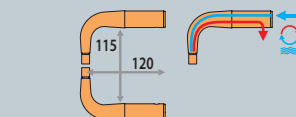
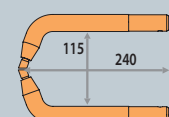
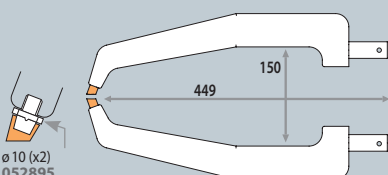
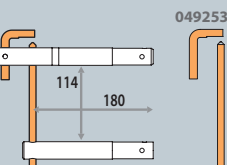
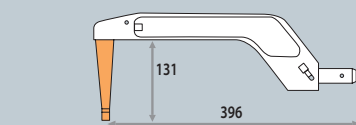
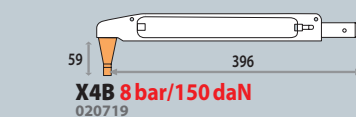
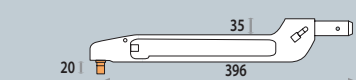
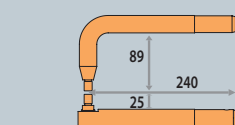
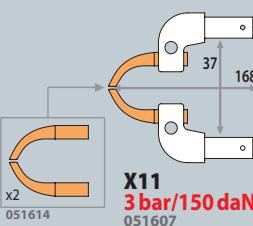
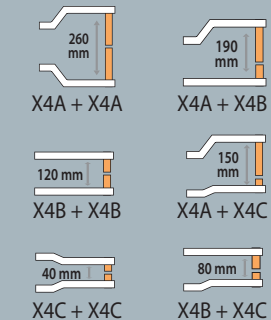
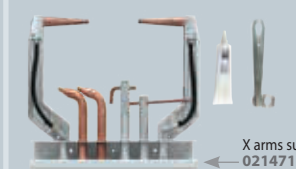
**X ARMS**
Ø 25 mm**X Arms - Caps Ø13 mm****X1 8 bar/550 daN**
050501**X2 8 bar/400 daN**
050518**X4 8 bar/120 daN**
050532**X5 8 bar/200 daN**
050549**X4A 8 bar/150 daN**
020702**X4B 8 bar/150 daN**
020719**X4C 8 bar/150 daN**
020726**X6 8 bar/400 daN**
050587**X4 (A, B & C) combinations****X11 3 bar/150 daN**
051607**X ARMS PANELS****X4A (x2) + X5 + X2**
022324X arms support
021471**X4A (x2) + X4B + X4C + X2**
020733X arms support
021471**Remote control (BP)****C ARMS PANELS**

C2 + C3 + C4
ALL IN 1 BOX
060821



C10 +
C3 +
C5 +
C6 +
C9
= 076495

FOR GYSPOT PTI**550 daN****Transformer inside****9,9 kg** including C1

- DOUBLE PRESSURE
- AIR COOLED + LIQUID COOLED / DOUBLE REFRIGÉRISSÉMENT AIR + LIQUIDE
- Ø 10 mm

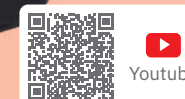
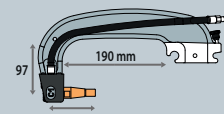
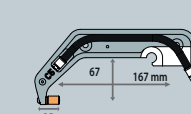
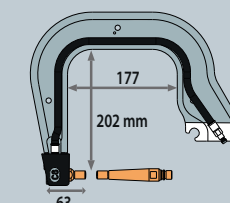
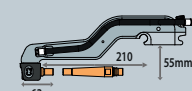
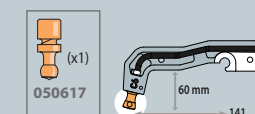
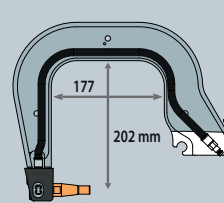
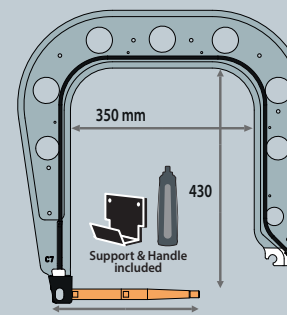
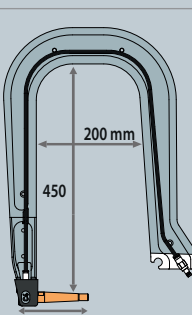
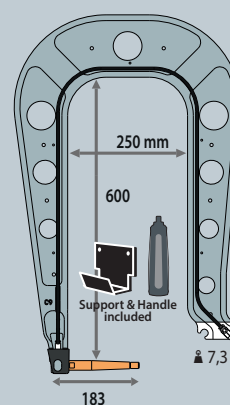
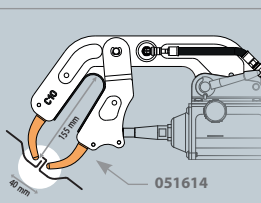
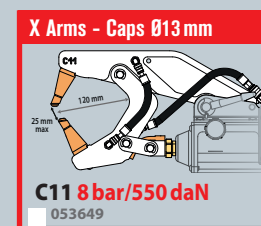
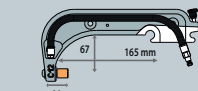
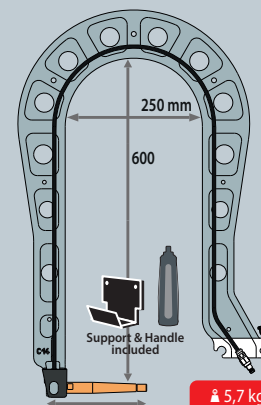
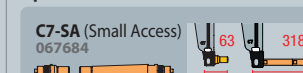
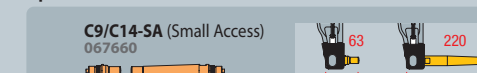
**C Arms - Caps Ø13 mm****Bras isolés - Isolated arms - Isolierte Bügel****C1 8 bar/550 daN**
021402**C5 8 bar/550 daN**
022393**C8 8 bar/550 daN**
021440**C2 8 bar/550 daN**
022386**C6 8 bar/300 daN**
022409**C3 8 bar/550 daN**
021419**C7 8 bar/550 daN**
021433**C4 8 bar/550 daN**
021426**C9 8 bar/550 daN**
020078**C10 4 bar/150 daN**
051638**C11 8 bar/550 daN**
053649**C12 8 bar/550 daN**
022997**C14 8 bar/400 daN**
0235435,7 kg
22% saved**Option for C7**C7-SA (Small Access)
067684**Option for C9 & C14**C9/C14-SA (Small Access)
067660



RIVETING



GYSPRESS 10T

6.5 bar 100 kN

10t

063303

070653

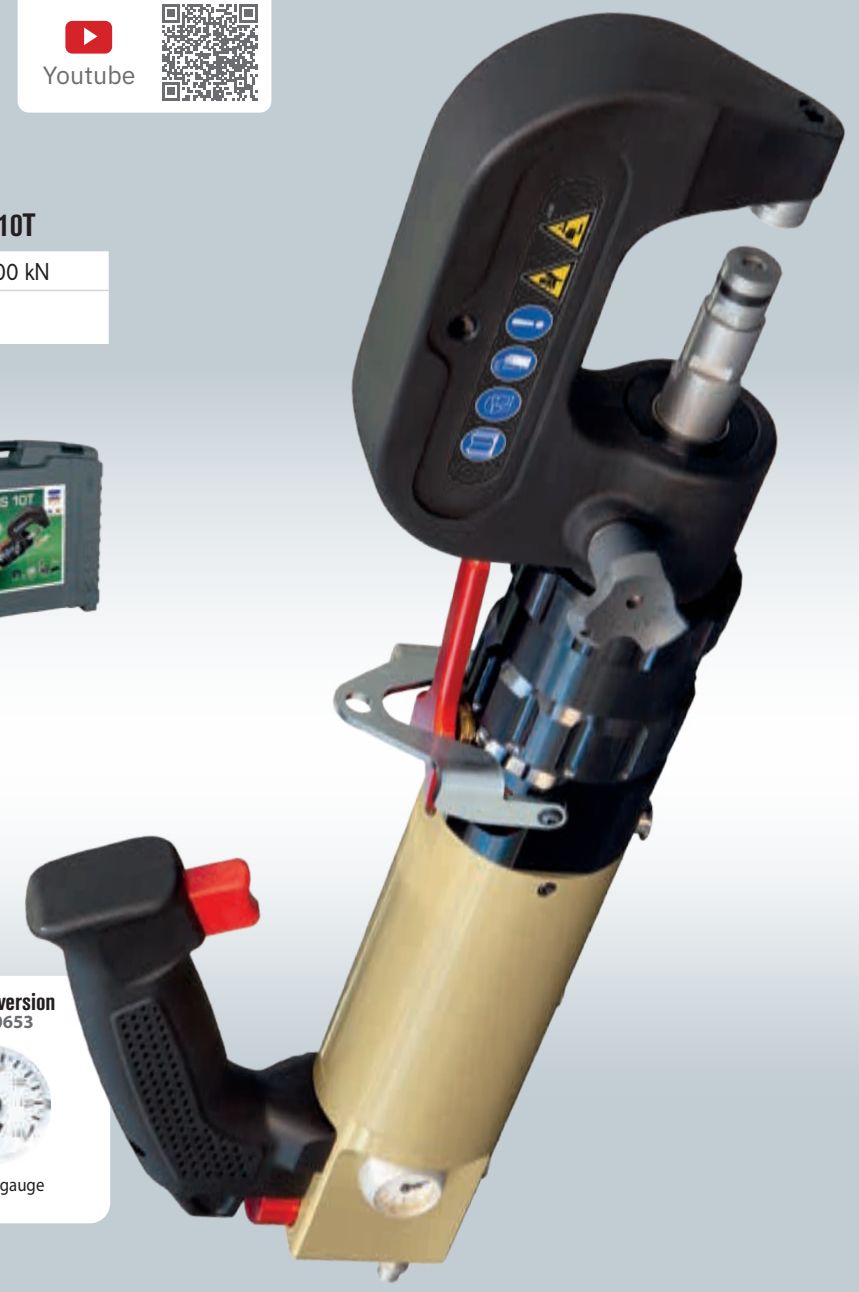

Discharge lever
- Levier de décharge - Auslösehebel



Speed control - Contrôle de la vitesse - Regelung
Werkzeuggeschwindigkeit



Pressure control
- Contrôle de la pression - Druckregelung



GYSPRESS 10T	73
GYSPRESS PREMIUM 10T PP	75
WORKSTATION	76
ADAPTERS	78
DIES BOXES & RIVETS	80
ACCESSORIES	83

GYSPRESS 10T COMPLETE PACKS

	HR110 063310	XT11.21 - Extension for HR110 & HR210 058644	Standard 10T tool box 053694	6 x 50 rivets RAP - Nieten SPR 048706	HR210 + HR310 064089	24kN adapter 063822	Trolley+support 055391
GYSPRESS 10T 063303 070653	✓						
GYSPRESS 10T pack 1 066441			✓				
GYSPRESS 10T pack 2 082991				✓			
GYSPRESS 10T pack 3 064744							✓

MADE IN FRANCE	AIR BAR	PRESSURE CONTROL	SPEED CONTROL	↕	⚖️	🧳
	cm	kg	LxWxH cm / kg			
GYSPRESS 10T	6.5 bar = 10 t (maxi 10 bar)	0 > 6.5 bar	+ -	39.5 x 180	6.2 (HR110 included)	58 x 50 x 15 / 12.1



	HR110	HR210	HR310
	063310	063327	063334
GYSPRESS 8T	✓	✓	—
GYSPRESS 10T	✓	✓	✓
GYSPRESS 8T PUSH PULL	✓	✓	✓
GYSPRESS PREMIUM 10T PUSH PULL	✓	✓	✓
GYSPRESS 10T PUSH PULL	✓	✓	✓
GYSPRESS 10T CONNECT	✓	✓	✓



KIT WITH HR210 + HR310 064089

XT31-40 Rallonges bras HR310 pour point milieu - HR310 arm extension for middle point

Compatible 8T PP/10T/10T PP x2

066335

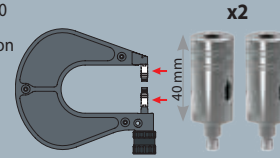

OPTIONS

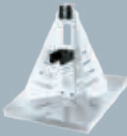

Riveting machine support for changing accessories (arms & dies)
- Support Riveteuse pour changements d'accessoires (bras & matrice)
- Supportständer

↓ 28 x 40 x 21,5 cm
⊗ 45 x 39 x 20 cm / 7,2 kg

054158



Trolley - Chariot

↓ 74 x 51 x 81 cm
⊗ 80 x 123 x 15 cm / 44 kg

054233



Trolley + Support Chariot + Support

↓ 51 x 74 x 122 cm
⊗ 51,2 kg

055391



Pressure sensor - Capteur d'effort 062115



Hydraulic body wrenches (x2) 067325



Temporary - Serre-tôles - fasteners manual mounting

- (x10) Ø 2,4 mm 069664
- (x10) Ø 4,0 mm 069671
- (x10) Ø 4,8 mm 069688
- (x10) Ø 6,4 mm 069695

GYSPRESS 10T PREMIUM PUSH PULL COMPLETE PACKS

	HR110 063310	XT11.21 - Extension for HR110 & HR210 058644	Standard 10T tool box 058631	6 x 50 rivets RAP - Nieten SPR 048706	HR210 + HR310 064089	24kN adapter 063822	Trolley+support 055391
GYSPRESS 10T PREMIUM PUSH PULL 077065	✓						
GYSPRESS 10T PPP pack 1 082519					✓		
GYSPRESS 10T PPP pack 2 082526							✓
GYSPRESS 10T PPP pack 3 082533							✓



GYSPRESS

PREMIUM PUSH PULL

GYSPRESS PREMIUM 10T PUSH PULL

6.5 bar 100 kN

10t

077065

070660



UNIQUE PUSH PULL SYSTEM by GYS

AUTO or MANUAL



LARGE OPENING

MORE ACCESS

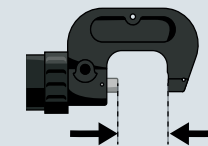

48.5 mm (no dies)
23.5 mm with B1/B2 dies

ERGONOMIC WITH QUICK SELECTION

WORK FASTER



Push/Pull selection - Sélection Push/Pull

MANUAL PULL MODE

OPENING CONTROL



Manual/Automatic selection - Sélection Manuel/Automatique



Pressure control - Contrôle de la pression - Druckregelung



Speed control - Contrôle de la vitesse - Regelung Werkzeuggeschwindigkeit

US version 070660



Pressure gauge Psi



UNIQUE 100% No air inclusion maintenance free, no oil refill

MADE IN FRANCE	AIR BAR	PRESSURE CONTROL	SPEED CONTROL	↕	⚖	📦
				cm	kg	kg
GYSPRESS 10T PREMIUM PUSH PULL	6.5 bar = 10 t (maxi 10 bar)	0 > 6.5 bar	↔	39.5 x 180	6.7 (HR110 included)	59 x 50 x 16 / 13.1



GYPRESS

SYNERGIC RIVETING WORKSTATION

PNEUMATIC HYDRAULIC



ACCESSIBILITY

16 languages

- FR PR CN
- GB CZ JP
- DE NL VN
- IT SE FI
- ES RU TR

★★★★★
SYNERGIC RIVETS SETTINGS

Main panel



Setup instructions

Results

3 MODES

- MANUAL
- SYNERGIC
- CAR MANUFACTURERS

CAR MANUFACTURERS COMPATIBILITY

- ✓ VW GROUP
- ✓ MERCEDES-BENZ
- ✓ BMW
- ✓ TESLA
- ✓ FERRARI
- ✓ FORD
- ✓ RENAULT ALPINE
- ✓ GM

CONNECTIVITY

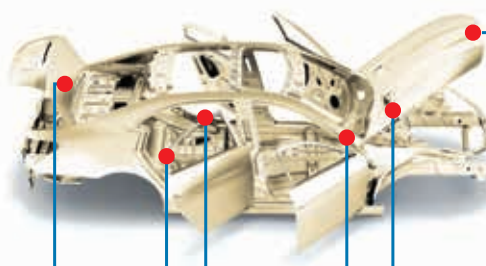

TRACEABILITY

History data export

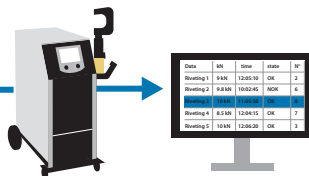

SOFTWARE UPDATE

Gyspress evolutions

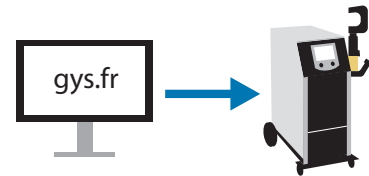

UNIQUE PUSH PULL SYSTEM by GYS

PUSH PULL SYSTEM by GYS

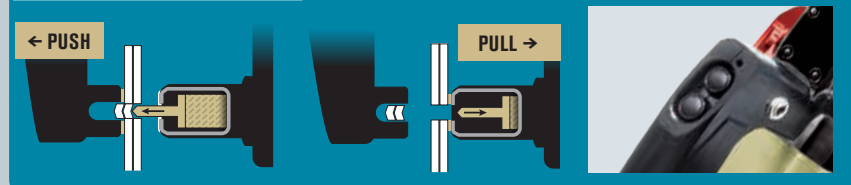

Sélection Push/Pull - Push/Pull selection

Gyspress support



Arms support



REGULATED PRESSURE CONTROL

POWER 10t

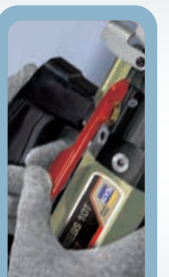

Discharge lever - Levier de décharge - Auslösehebel

WORKSTATION GYPRESS 10T PP CONTROL

6.5 bar 100 kN

10t

063860

Included



OPTIONS

Pressure gauge - Capteur d'effort 10T PP CONTROL 071759

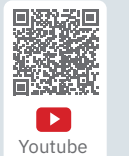

Hydraulic body wrenches for GYPRESS 10T, 10T PushPull, 10T PP CONTROL (x2) 067325

MADE IN FRANCE WORKSTATION GYPRESS 10T PP CONTROL	230V	AIR BAR 6.5 bar = 10t (maxi 10 bar)	PRESSURE CONTROL 0 > 6.5 bar	SPEED CONTROL + -	LxWxH cm / kg	LxWxH cm / kg
					74 x 50 x 116 / 54	76 x 42 x 94 / 64.4

SYNERGIC RIVETING GYPRESS CONTROL



**BLIND RIVET ADAPTERS
- ADAPTATEURS POUR RIVETS AVEUGLES**

GYPESPRESS

Adaptators

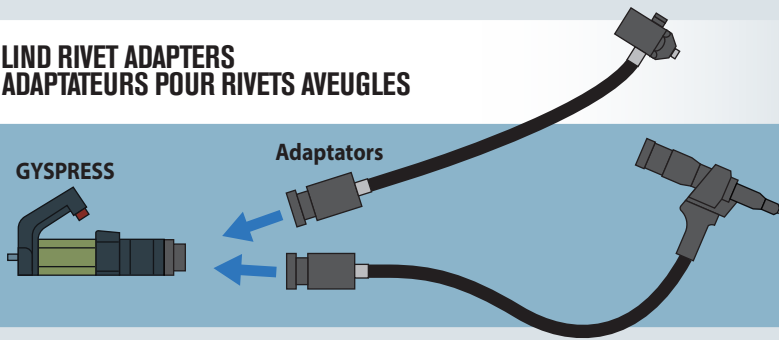

Compatibility

- GYPESPRESS 10T
- GYPESPRESS 10T PUSH PULL
- GYPESPRESS 10T PUSH PULL PREMIUM
- GYPESPRESS 10T CONNECT



Youtube

BLIND RIVET ADAPTER 24 kN - Adaptateur 24 kn pour rivets aveugles - Blindnietadapter 24 kN

24 kN STANDARD 600 mm
063822

Pour rivets POP - For BLIND rivets - Für Blindniet
Acier / Steel : Ø 4.0 → 6.4
Alu: Ø 4.0 → 7.8



INCLUDED

- 058446
- for standard rivets: Ø 3.2 x1 059221, Ø 3.6 x1 059238
- Ø 4.0 x1 059245, Ø 4.5 x1 059252

24 kN COMPACT 600 mm
077164

Pour rivets POP - For BLIND rivets - Für Blindniet
Acier / Steel : Ø 6.4
Alu: Ø 6.4 → 7.8

COMPACT HEAD

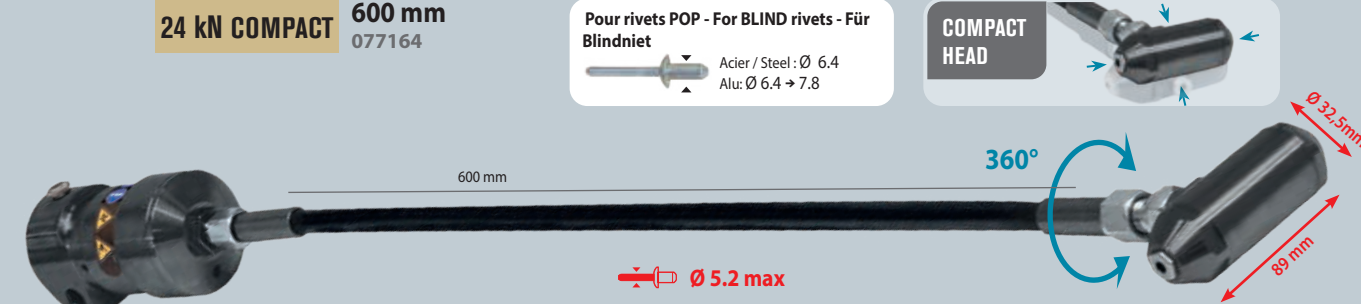

INCLUDED

- 058446
- for standard rivets: Ø 4.5 x1 081222, Ø 5.2 x1 079939

OPTION

- for extraction of self piercing rivet: Rivet-extraction insert - Buse d'extraction 24kN compact Ø 5 079946

HIGH ACCESSIBILITY



SPECIFIC STORAGE



PERFECT COMBO WITH ARCPULL

SPECIAL TEARING RIVETS
- Spécial arrachage de rivets
- Spezial-Zugnieten



OPTION FOR GYSPOT ARCPULL (details p.17)

for GYSPOT ARCPULL 350

ARC PULL RIVET BOX1 350 - 24kN 064584					
Stainless steel nail - Tige inox Ø 4 x 50 mm 064607	Barrel for stainless steel nail welding - Canon pour pose de tige inox	Mandrel support - Support porte-goujon 059634	Nozzle + pad - Buse + patin 059641	Mandrel Ø4mm 049000	Buse d'extraction 24kN Ø 4 064683
x100	x1	x1	x1	x1	x1

BLIND RIVET ADAPTER 50 kN - Adaptateur 50 kn pour rivets aveugles - Blindnietadapter 50 kN



Stroke adjustment - Réglage de la course de traction
0 → 25 mm

50 kN 1 m
064867
4.0 kg

For BLIND rivets - Pour rivets POP - Für Blindniet

Steel / Acier : Ø 4.0 → 6.4
Alu: Ø 4.0 → 7.8

INCLUDED

Kit Standard



Complete kit 065987



OPTIONS

Steel / Acier : Ø 4.0 → 6.4
Alu: Ø 4.0 → 7.8

160 mm extension - Extension 160 mm - Verlängerung 160 mm
066144



Ø 8.0 → 9.8

Ø8.0/9.8mm nozzle-piece kit - Kit Rivets Ø8.0/9.8mm - Mundstückkit 8,0/9,8 mm
066045



M5 → M14
M5 → M8

Blind rivet nut pulling, Blind rivet bolt adapter kit - Kit 6 tirants pour pose d'écrous à sertir et goujons à sertir - Blindnietmuttern, Blindnietgewindebolzen-Kit
066076



OPTION FOR GYSPOT ARCPULL (details p.17)

for GYSPOT ARCPULL 350

ARCPULL RIVET BOX2 350 - 50kN 073388				
Ø 5 x 50 mm 070745	Long barrel + mandrel M5 - Canon long + mandrin M5 070738	Mandrel support - Support porte-goujon 059634	Buse + pad 059641	Buse d'extraction 50kN Ø 5 066151
x100	x1	x1	x1	x1

for GYSPOT ARCPULL 700

ARCPULL RIVET BOX 700 068452									
Ø 5 x 50 mm 070745	Long barrel + mandrel M5 - Canon long + mandrin M5 070738	Buse d'extraction 50kN Ø 5 066151	Mandrel support - Support porte-goujon 071377	Buse + pad 059641	Ring holder 059610	Rod for pulling rings - Fourche pour anneau 071384	Vis de butée	Rod for pulling rings - Fourche pour anneau 071384	Vis de butée
x100	x1	x1	x1	x1	x2	x1	x1	x1	x1

CONSUMABLES BOX FOR 50KN ADAPTER - Boîte consommables pour adaptateur 50kN - Zubehörbox für 50 kN Adapter

066168					
Blind rivet nuts - Écrous à sertir	Blind rivet bolts - Goujons à sertir	Blind rivets - Rivets aveugles	Blind rivet nuts - Écrous à sertir	Blind rivet bolts - Goujons à sertir	Blind rivets - Rivets aveugles
M5, M6, M8, M10, M12, M14	M5, M6, M8	Ø 6.4, Ø 9.8	M5, M6, M8	M5, M6, M8	Ø 6.4, Ø 9.8
22.5 → 27, 24 → 28.5, 23.5 → 28	2.8 → 4.8, 3.0 → 14.0	Ø 6.4, Ø 9.8	22.5 → 27, 24 → 28.5, 23.5 → 28	2.8 → 4.8, 3.0 → 14.0	Ø 6.4, Ø 9.8
0.5 → 3.0, 0.5 → 3.0, 0.5 → 3.0, 1.0 → 3.5, 1.0 → 4.0, 4.5 → 6.0	0.5 → 3.0, 0.5 → 3.0, 0.5 → 3.0	2.8 → 4.8, 3.0 → 14.0	0.5 → 3.0, 0.5 → 3.0, 0.5 → 3.0	0.5 → 3.0, 0.5 → 3.0, 0.5 → 3.0	2.8 → 4.8, 3.0 → 14.0
x 50 066175, x 50 066182, x 50 066199, x 50 066205, x 50 066212, x 10 066229	X 50 066236, X 50 066243, X 50 066250	x 50 066267, x 50 066274	X 50 066236, X 50 066243, X 50 066250	X 50 066236, X 50 066243, X 50 066250	x 50 066267, x 50 066274
+ demo metal sheet - plaque de démonstration	+ x 10 x 10 x 10 x 10 x 10 x 5	+ x 10 x 10 x 10	+ x 10 x 10 x 10	+ x 10 x 10 x 10	+ x 10 x 10

DIES - Matrices - Matrizen

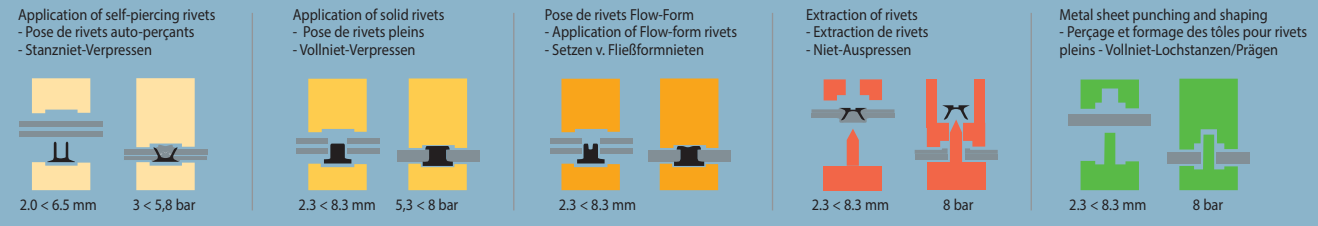

Ø 8																				
A1	A2	B1	B2	B3	B4	B5	B6	D1	D2	D3	D4	D5	D6	D7	D8	D9	D10	D11	D12	D13
055698	055704	055711	055728	055735	059016	059023	059030	055971	055988	055995	055742	056008	056015	056022	056039	056046	055674	056060	056053	055759
A1+A2		B1+B2																		
054295		054301																		

D15	D16	D17	D18	E1		E2	E3	E6	E7	E9	E10	E11	E12	E13	F1	F2	F3	F4	F45					
056077	056084	055681	071155	055865	054288	055766	057005	057142	057159	058606	058613	058620	058828	059085	055773	055780	055797	055803	083547					
				E1+E2																		F1+F2		
				054318																		054714		NEW

F5	F6	G1	G2	G3	G4	G5	G6	H1	H2	H3	H4	H5	H6	H7	H8	I1	I2	I3	J1	J2
055810	071148	057173	057180	057197	057203	057210	057227	068230	068247	068254	068261	068278	068285	068292	068308	071117	071124	071131	071674	071902

Ø 6													Ø 6		Ø 6			Ø 8		Ø 6.7	
S1	S3	S4	S5	S7	S8	ST1	ST2	ST3	T1	T2	T3	T4	T5	T7	T8	T10	T12	T13			
057036	057043	057050	057067	057074	057081	058071	058088	066397	057098	059078	057104	055827	055834	058019	058033	058040	058064	066373	066380		
													T1+T2								
													054707								

BREVET GYS / GYS PATENT n° US 11,712,732

Ø 6.7		Ø 6		Ø 8		Ø 10	
T14	T15	T16	T17	T18	T19	T20	T25
066410	066427	068964	066434	069312	069329	071254	082854

SELF PIERCING RIVETS (SPR)
- Rivets auto-perçants (RAP) - Stanznieten

Steel - Acier - Stahl

Complete box 048706

Ø 3,3 x 3,5 mm x 50	Ø 3,3 x 4 mm x 50	Ø 5,3 x 4 mm x 50	Ø 5,3 x 5 mm x 50	Ø 5,3 x 6 mm x 50	Ø 5,3 x 8 mm x 50	Ø 5,3 x 7 mm	Ø 5,3 x 9 mm
x 200 048232	x 200 048249	x 100 048256	x 100 048263	x 100 048270	x 100 048225	x 100 048638	x 100 048645

SPECIAL CENTER PUNCH
- Pointeau centreur - Spezialkörner



HYDROPNEUMATIC TOOL FOR BLIND RIVETS
- Riveteuse hydro-pneumatique - Hydro-pneum. Blindnietgerät

For BLIND rivets - Pour rivets POP - Für Blindniet
 Steel → 6.4 mm
 Alu → 7.8 mm
 Ø 4.0 → 7.8

HR21
max 21 000 N (6 bar)
055407

MADE IN ITALY

included (x3) 058446

For standard rivets Ø 4.0 51508

For Magnarive rivets Ø 4.5 51507

Option HR21 extension 100 mm 063105

CORDLESS RIVETER - Riveteuse sur batterie
- Akku-Blindnietgerät

For BLIND rivets - Pour rivets POP - Für Blindniet
 Ø 4.0/4.8/5.0/6.0/6.4

TWO ER20
max 20 000 N (6 bar)
10-20 V universal fast charger (30 min)
2.0 kg
064461

BRUSHLESS motor

2 x 20V/2Ah Li-ion battery

HYDROPNEUMATIC TOOL FOR BLIND RIVETS
hydro-pneumatique - Hydro-pneum. Blindnietgerät

For BLIND rivets - Pour rivets POP - Für Blindniet
 Steel / Acier Ø 4.0/4.8/6.4
 Alu Ø 4.0/4.8/6.4

HR14
max 14 000 N
057241

Made in Taiwan

MANUAL TOOL FOR BLIND RIVETS
- Riveteuse manuelle - Manueller Blindnietgerät

For BLIND rivets - Pour rivets POP - Für Blindniet
 Steel / Acier Ø 3.2/4.0/4.8/6.4
 Alu Ø 3.2/4.0/4.8/6.4

061323
Made in Taiwan

HYDROPNEUMATIC TOOL FOR RIVET NUTS
hydro-pneumatique riv 998 - Hydro-pneum. Blindnietmuttergerät

Sealing nuts - Ecrous à sertir - Blindnietmuttern

RIV 998
For sealing nuts from M3 to M12
Pour la pose d'écrous à sertir M3 à M12

max 19 000 N (6 bar)
included accessories for sealing nuts:
- livré avec accessoires pour écrous à sertir:

- ✓ M3 ✓ M4
- ✓ M5 ✓ M6
- ✓ M8 ✓ M10
- ✓ M12

055414

MADE IN ITALY

HYDROPNEUMATIC TOOL FOR BLIND RIVETS
- Riveteuse hydro-pneumatique - Hydro-pneum. Blindnietgerät

For BLIND rivets - Pour rivets POP - Für Blindniet
 Steel / Acier Ø 3.2/4.0/4.8
 Alu Ø 3.2/4.0/4.8

HR9
max 9 000 N
057234

Made in Taiwan



MIG-MAG GMAW-FCAW

TRADITIONAL

GYS AUTO 86

INVERTER

E GYS AUTO 88

NEW

P GYS AUTO 90

AUTOPULSE 92

ACCESSORIES & CONSUMABLES 96

MIG/MAG TRADITIONAL SYNERGIC

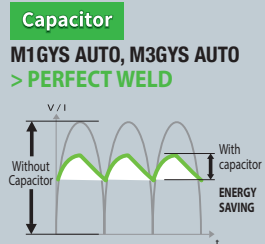

SYNERGIC EASY TO USE
Auto adaptative wire speed
- Réglage automatique de la vitesse
- Automatische Einstellung der Drahtgeschwindigkeit

M1 GYS AUTO

15 160 A Capacitor
230V • 1~
032903
208/240V • 1~
032088

6m
2m

with accessories

T1 GYS AUTO DV

15 200 A
400V • 3~ / 230V • 3~
032927

with accessories

M3 GYS AUTO

15 160 A Capacitor
230V • 1~
032880

6m

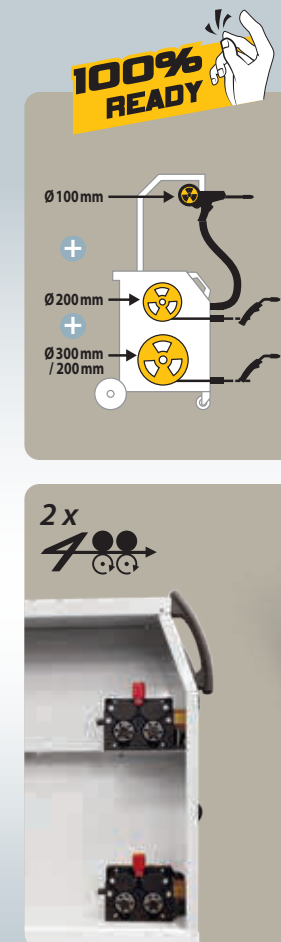

Protection gas
Argon+CO₂ (Steel, Inox)
Argon (ALU/CuSi3/CuAl8)
CO₂PUR (Steel)

Spool Gun Torch
- Torche motorisée Spool Gun
- Spool Gun Brenner



SPOOL GUN + Support
for M3 GYS AUTO



MADE IN FRANCE	MADE IN CHINA	CE MARKING 60974/1	50/60 Hz	A	min → max	Reg	100 (spoolgun) 200 300	Electronic Control	EN60974-1 (40°C)		Ø mm	Original equipment	Protected & compatible power generator (+/-15%)		
									IA (60%)	X% (I2 max)					
			230V 1~	16	15 → 160	6	option	4	90	140A@15%	0.6+1	0.6/0.8	0.8	78 x 38 x 67 / 56	4,5 kVA
			208/240V 1~											37 x 79 x 67 / 57.5	
			230V 3~/400V 3~	10	15 → 200	7	option	4	110	150A@25%	0.6+1	0.6/0.8	0.8	37 x 78 x 67 / 62	5.2 kVA
			230V 1~	16	15 → 160	6		4	90	140A@15%	0.6+1	0.6/0.8 0.8/1.0	2 x 0.8	74 x 40 x 85 / 77.5	4,5 kVA



E GYS AUTO

MIG/MAG INVERTER SYNERGIC

Lastest generation
colour screen 3.5"

EASY



EXPERT

Pre-gas / Creep speed/ Hotstart /
Crater filler / Burnback / Post-gas



Screen protection -
Protection d'écran -
Bildschirmschutz
079885



EASY TO SETUP



MODES

- MANUAL
- SYNERGIC EASY / EXPERT
- 2T
- 4T
- SPOT
- DELAY

FONCTIONS

- TRACEABILITY
- PORTABILITY
- +500 JOBS can be saved

SYNERGIES

- STEEL
- AlSi
- AlMg
- Cu Si 3 / CuAl 8
- CrNi

UPDATES



EASY USB
UPDATE

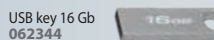

USB key 16 Gb
062344

E1 GYS AUTO

10 200 A

230V 1~

PFC

with accessories :

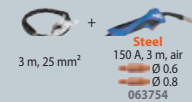

3 m, 25 mm²

Steel
150 A, 3 m, air
Ø 0.6
Ø 0.8
063754

075122

E2 GYS AUTO

10 200 A

230V 1~

PFC

with accessories :

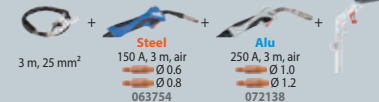

3 m, 25 mm²

Steel
150 A, 3 m, air
Ø 0.6
Ø 0.8
063754

Alu
250 A, 3 m, air
Ø 1.0
Ø 1.2
072138

075139

E3 GYS AUTO

10 200 A

230V 1~

PFC

with accessories :

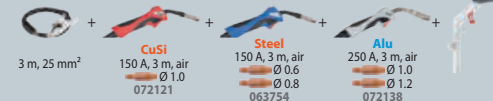

3 m, 25 mm²

CuSi
150 A, 3 m, air
Ø 1.0
072121

Steel
150 A, 3 m, air
Ø 0.6
Ø 0.8
063754

Alu
250 A, 3 m, air
Ø 1.0
Ø 1.2
072138

075160



4 m³
(20L)

1 x

6 m



2 x 4 m³
(20L)

2 x

6 m

2 x 4 m³
(20L)

3 x

6 m

E1 GYS AUTO 200 A • × 1

E2 GYS AUTO 200 A • × 2

E3 GYS AUTO 200 A • × 3

MADE IN FRANCE	CE NORM. 60974/1	50/60 Hz	A	6 m	min → max A	Ø mm		Electronic Control	EN60974-1 (40°C)		Original equipment Equipement d'origine Originalausstattung Equipamiento de fabrica	LxWxH cm / kg	Protected & compatible power generator (+/-15%)	
						200	300		IA (60%)	X% (I2 max)				
▪	E1 GYS AUTO	230V 1~	16	6 m	10 → 200	▪	▪		145	200 A @ 20%	0.6 → 1	Acier Type B 0.6/0.8	79 x 37 67 / 42.6	9KVA
▪	E2 GYS AUTO	230V 1~	16	6 m	10 → 200	▪	▪		145	200 A @ 20%	0.6 → 1	Acier Type B 0.6/0.8 Alu Type B 0.8/1	72 x 37 x 105 / 59.5	9KVA
▪	E3 GYS AUTO	230V 1~	16	6 m	10 → 200	▪	▪		145	200 A @ 20%	0.6 → 1	Acier Type B 0.6/0.8 Acier Type B 0.8/1 Alu Type B 0.8/1	73 x 38 x 108 / 64	9KVA

E GYS AUTO
SYNERGIC MIG GMAW FCAW





P GYS AUTO

MIG/MAG PULSE SYNERGIC

NEW

16 languages

- French
- English
- German
- Italian
- Spanish
- Portuguese
- Czech
- Polish
- Dutch
- Swedish
- Russian
- Chinese
- Japanese
- Vietnamese
- Finnish
- Turkish

Lastest generation colour screen 3.5"

EASY



EXPERT

Pre-gas / Creep speed/ Hotstart / Crater filler / Burnback / Post-gas



EASY TO SETUP



Screen protection - Protection d'écran - Bildschirmschutz 079885

MODES

EASY

- SYNERGIC STANDARD
- SYNERGIC PULSE

EXPERT

- MANUAL
- SYNERGIC STANDARD
- SYNERGIC PULSE

TORCH

2T

4T

SPOT

SPOT DELAY

FONCTIONS

TRACEABILITY

PORTABILITY

+500 JOBS can be saved

SYNERGIES

STEEL - ACIER

ALU

STAINLESS STEEL - INOX

BRAZING - BRASAGE

+40 SYNERGIES

UPDATES



EASY USB UPDATE

USB key 16 Gb 062344

10 → 220 A
Ideal 0.6 mm

P1 GYS AUTO

10 → 220 A 230V 1~ PFC

with accessories :

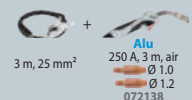

080584

P1 GYS AUTO 208-240V

10 → 220 A 208>240V 1~ PFC

with accessories :

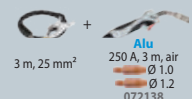

080911



1 x

P1 GYS AUTO 220 A • × 1

P2 GYS AUTO

10 → 220 A 230V 1~ PFC

with accessories :

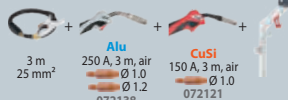

083134

P2 GYS AUTO 208-240V

10 → 220 A 208>240V 1~ PFC

with accessories :

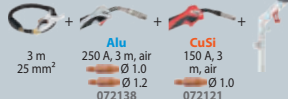

083189



2 x

P2 GYS AUTO 220 A • × 2

P3 GYS AUTO

10 → 220 A 230V 1~ PFC

with accessories :

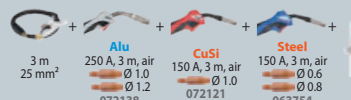

080591

P3 GYS AUTO 208-240V

10 → 220 A 208>240V 1~ PFC

with accessories :

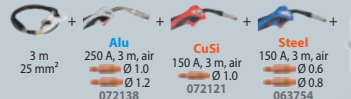

080928

Cable support P2/P3 077300



3 x

P3 GYS AUTO 220 A • × 3

MADE IN FRANCE	CE NORM. 60974/1	50/60 Hz	A	6m	min → max	A	200	300	Electronic Control	EN60974-1 (40°C)		Ø mm	Original equipment / Equipement d'origine / Originalausstattung / Equipamiento de fabrica			LxWxH cm / kg	Protected & compatible power generator (+/-15%)
										IA (60%)	X% (I2 max)		Alu Type B 1.0/1.2	Steel Type B 0.8/1.0	Steel Type B 0.6/0.8		
▪	P1 GYS AUTO	230V 1~	16		10 → 220	▪	▪	1 x		150	220 A @ 20 %	0.6 → 1.2	Alu Type B 1.0/1.2		78 x 45 x 80 / 45	9KVA	
▪	P1 GYS AUTO 208-240V	208 > 240V 1~	16	6m	10 → 220	▪	▪	1 x		150	220 A @ 20 %	0.6 → 1.2	Alu Type B 1.0/1.2		78 x 45 x 80 / -	9KVA	
▪	P2 GYS AUTO	230V 1~	16		10 → 220	▪	▪	2 x		150	220 A @ 20 %	0.6 → 1.2	Alu Type B 1.0/1.2	Steel Type B 0.8/1.0	86 x 63 x 93 / 58	9KVA	
▪	P2 GYS AUTO 208-240V	208 > 240V 1~	16	6m	10 → 220	▪	▪	2 x		150	220 A @ 20 %	0.6 → 1.2	Alu Type B 1.0/1.2	Steel Type B 0.8/1.0	86 x 63 x 93 / -	9KVA	
▪	P3 GYS AUTO	230V 1~	16		10 → 220	▪	-	3 x		150	220 A @ 20 %	0.6 → 1.2	Alu Type B 1.0/1.2	Steel Type B 0.8/1.0	86 x 63 x 93 / 62	9KVA	
▪	P3 GYS AUTO 208-240V	208 > 240V 1~	16	6m	10 → 220	▪	-	3 x		150	220 A @ 20 %	0.6 → 1.2	Alu Type B 1.0/1.2	Steel Type B 0.8/1.0	86 x 63 x 93 / -	9KVA	



91

P GYS AUTO
PULSE SYNERGIC MIG
GMW FCAW



MIG/MAG DOUBLE PULSE SYNERGIC

Latest generation
colour screen 5"
800 x 480 (WVGA)



ACCESSIBILITY

3 interface levels

- EASY
- EXPERT
- ADVANCED

16 languages

- French
- English
- German
- Italian
- Spanish
- Portuguese
- Czech
- Polish
- Dutch
- Swedish
- Russian
- Chinese
- Japanese
- Vietnamese
- Finnish
- Turkish

EASY



3 INTERFACE LEVELS

ADVANCED
Arc length adjustments



EXPERT

Pre-gas / Hot Start / Upslope / Downslope / Crater filler / Post-gas



500+ JOBS can be saved



TRACEABILITY



PORTABILITY



MODES

- DYNAMIC STANDARD
- PULSE
- PULSE IN PULSE
- MANUAL
- COLD PULSE**

FULLY DIGITAL

4 MICROPROCESSORS



65+ SYNERGIES

Find all the synergies:
Retrouvez toutes les synergies:
Finde alle Synergien:



STEEL

Cu Si 3 / Cu Al 8

ALU

UPDATES

EASY USB UPDATE

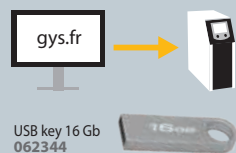

OPTIONS

PUSH PULL TORCH 24 V

MB 25
4 m
046283



Motor inside



MB 15 / MB 25
(250 A)
077089

- x5 (M6-0.6)
- x5 (M6-0.8)
- x5 (M6-1.0)
- x5 (Alu-M6-0.1.0)
- x5 (Alu-M6-0.1.2)



Torch gas flow-meter
- Débitmètre de bout de torche
053939



Protection cover
- Housses de protection
- Schutzhaube
052260

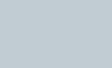

AUTOPULSE 220-M1



AUTOPULSE 220-M2



AUTOPULSE 220-M1

10 220 A

230V 1~

PFC

with accessories:

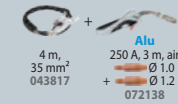

065024



AUTOPULSE 220-M2

10 220 A

230V 1~

PFC

with accessories:

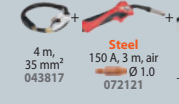

069855

AUTOPULSE 220-M2 208-240V

10 220 A

208>240V 1~

PFC

with accessories:



069862



10 m³ (50L)



PFC POWER FACTOR CORRECTION

185 V ← 265 V



45 m



2 x 4 m³ (20L)



220 A • x1

220 A • x2

	MADE IN FRANCE	CE NORM. EN60974-1	50/60 Hz	A	Ø mm	A	min → max	SPOOLGUN	PUSH/PULL	200 300	Ø mm	Cooling system	ELECTRONIC CONTROL	IA (60%)	X% (12 max)	LxWxH cm / kg	Protected & compatible power generator (+/-15%)
AUTOPULSE 220-M1	MADE IN FRANCE	CE NORM. EN60974-1	50/60 Hz	A	Ø mm	A	min → max	SPOOLGUN	PUSH/PULL	200 300	Ø mm	Cooling system	ELECTRONIC CONTROL	IA (60%)	X% (12 max)	75 x 41 x 94 / 65.5	10 kVA
AUTOPULSE 220-M2	MADE IN FRANCE	CE NORM. EN60974-1	50/60 Hz	A	Ø mm	A	min → max	SPOOLGUN	PUSH/PULL	200 300	Ø mm	Cooling system	ELECTRONIC CONTROL	IA (60%)	X% (12 max)	74 x 41 x 93 / 78.8	10 kVA
AUTOPULSE 220-M2 208-240V	MADE IN FRANCE	CE NORM. EN60974-1	50/60 Hz	A	Ø mm	A	min → max	SPOOLGUN	PUSH/PULL	200 300	Ø mm	Cooling system	ELECTRONIC CONTROL	IA (60%)	X% (12 max)	74 x 40 x 93 / 79.8	10 kVA



MIG/MAG DOUBLE PULSE SYNERGIC

BODYSHOP SPECIFIC
COLD PULSE
CuSi3 Ø 0.8/1



Helmet not included

2 x 4 m³
(20L)

3 x

8 m

PFC POWER FACTOR CORRECTION

185 V ← 265 V

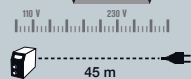

AUTOPULSE 220-M3

1				PP
2			-	-
3			-	-

LIC ELECTRONIC

AUTOPULSE 220-M3

10 **220 A** 230V 1~ PFC

with accessories:

4 m, 35 mm² 043817 + CuSi 150 A, 3 m, air Ø 1.0 072121 + Steel 150 A, 3 m, air Ø 0.8 063754 + Alu 250 A, 3 m, air Ø 1.0 Ø 1.2 072138

036703

AUTOPULSE 220-M3 208-240V

10 **220 A** 208>240V 1~ PFC

with accessories:

4 m, 35 mm² 043817 + CuSi 150 A, 3 m, air Ø 1.0 072121 + Steel 150 A, 3 m, air Ø 0.8 063754 + Alu 250 A, 3 m, air Ø 1.0 Ø 1.2 072138

062481

OPTIONS

PUSH PULL TORCH 24 V

MB 25 4m 046283

Motor inside

Torch gas flow-meter - Débitmètre de bout de torche 053939

MB 15 / MB 25 (250 A) 077089

Protection cover - Housse de protection - Schutzhaube 052260

- x5 (Mg-Ø 0.6)
- x5 (Mg-Ø 0.8)
- x5 (Mg-Ø 1.0)
- x5 (Mg-Ø 0.8)
- x5 (Mg-Ø 1.0)
- x5 (Alu - Mg-Ø 1.0)
- x5 (Alu - Mg-Ø 1.2)

AUTOPULSE 320-T1

1				PP
2	-	-	-	-
3	-	-	-	-

AUTOPULSE 320-T3

1				PP
2				-
3				-

AUTOPULSE 320-T3 208-240V

1				PP
2				-
3				-

LIC ELECTRONIC

AUTOPULSE 320-T1

15 **320 A** 400V 3~

with accessories:

4 m, 35 mm² 043817 + Alu 250 A, 3 m, air Ø 1.0 Ø 1.2 072138

069831



10 m³
(50L)

1 x

5 m

AUTOPULSE 320-T3

15 **320 A** 400V 3~

with accessories:

4 m, 35 mm² 043817 + Steel 250 A, 3 m, air Ø 1.0 072152 + Steel 250 A, 3 m, air Ø 0.8 072145 + Alu 250 A, 3 m, air Ø 1.0 Ø 1.2 072138

067615

AUTOPULSE 320-T3 208-240V

15 **320 A** 208>240V 3~ PFC

with accessories:

4 m, 35 mm² 043817 + Steel 250 A, 3 m, air Ø 1.0 072152 + Steel 250 A, 3 m, air Ø 0.8 072145 + Alu 250 A, 3 m, air Ø 1.0 Ø 1.2 072138

036970

2 x 4 m³
(20L)

3 x

OPTIONS

for AUTOPULSE 320-T3 (400V) only

SPOOLGUN TORCH

Ideal Alu

Ø 0,8

4m 041486

Motor inside

Ø 100

220 A • x 3

320 A • x 1

320 A • x 3

MADE IN FRANCE EN60974-1	50 / 60 Hz	A	Ø mm	min → max	SPOOLGUN	PUSH/PULL	200	Cooling system	Equipement d'origine Original equipment Originalausstattung Equipamiento de fabrica		EN60974-1 (40°C)		LxWxH cm / kg	Protected & compatible power generator (+/-15%)
									ELECTRONIC CONTROL	IA (60%)	X% (I2 max)			
AUTOPULSE 220-M3	230 V · 1~	8 m	16	0.6+1.2	10+220	-	OPTION	Air		ACIER : Type B 0.6 / 0.8 ACIER : Type B 0.8 / 1.0 ALU : Type B 1.0 / 1.2	150	220 A @ 20%	75 x 41 x 94 / 80	10 kVA
AUTOPULSE 220-M3 208-240V	208>240 V · 1~	8 m	16	0.6+1.2	10+220	-	OPTION	Air		ACIER : Type B 0.6 / 0.8 ACIER : Type B 0.8 / 1.0 ALU : Type B 1.0 / 1.2	150	220 A @ 20%	75 x 41 x 94 / 80	10 kVA

MADE IN FRANCE EN60974-1	50 / 60 Hz	A	Ø mm	min → max	SPOOLGUN	PUSH/PULL	200 / 300	Cooling system	Original equipment Equipement d'origine Originalausstattung Equipamiento de fabrica		EN60974-1 (40°C)		LxWxH cm / kg	Protected & compatible power generator (+/-15%)
									ELECTRONIC CONTROL	IA (60%)	X% (I2 max)			
AUTOPULSE 320-T1	400 V · 3~	5 m	16	0.6+1.2	15+320	-	OPTION	Air		ALU : Type B 1.0 / 1.2	260	320 A @ 35%	74 x 41 x 94 / 65.1	16 kVA
AUTOPULSE 320-T3	400 V · 3~	5 m	16	0.6+1.2	15+320	OPTION	OPTION	Air		ACIER : Type C 0.8 / 1.0 mm ALU : Type C 1.0 / 1.2	260	320 A @ 35%	75 x 40 x 94 / 82	16 kVA
AUTOPULSE 320-T3 208-240V	208-240 V · 3~	5 m	25	0.6+1.2	15+320	-	OPTION	Air		ACIER : Type C 0.8 / 1.0 mm ALU : Type C 1.0 / 1.2	260	320 A @ 35%	74 x 41 x 95 / 82	16 kVA

MANUAL TORCHES

- Torches manuelles - Brenner
- Antorcha - Lastoort - Tocha

CLASSIC



Flexible



CLASSIC GRIP



CONFORT GRIP
360°

FUME EXTRACTION

Fume Extraction Torches - Torches aspirantes - Rauchgas-Absaugbrenner - Antorcha con aspiración de humos



Complete systems (p. 121)



PUSH PULL

for AUTOPULSE



Light weight

Rollers - Galets - Drahtführungsrollen
- Rollen - Rodillos - Wielen - Roletes
0.6/0.8/1.0 046290
0.8/1.0/1.2 038752

Connector Push Pull 10 pts
064393



SPOOL GUN

Special CAR BODY REPAIR MACHINES



∅ 100



COMPLETE TORCHES

X % 40°C, ArCo ₂	Steel/Stainless steel - Acier / Inox - Stahl/Edelstahl						ALU - Aluminium - Aluminio					PUSH PULL AIR	SPOOL GUN AIR
	AIR			LIQUID			AIR			LIQUID			
	150 A	150 A	250 A	250 A	350 A	300 A	150 A	250 A	250 A	350 A	300 A		
	A1 + A2	A1 + A2	B1 + B2	B1 + B2	D1 + D2	C1 + C2	A1 + A2	B1 + B2	B1 + B2	D1 + D2	C1 + C2	B1 + B2	A1 + A2
	M6 ∅0.8	M6 ∅1.0	M6 ∅0.8	M6 ∅1.0	M8 ∅1.2	M6 ∅1.2	M6 ∅0.8	M6 ∅1.0	M6 ∅1.2	M8 ∅1.2	M6 ∅1.2	M6 ∅1.2	M6 ∅0.8
	3 m	3 m	3 m	3 m	4 m	3 m	3 m	3 m	3 m	3 m	3 m	4 m	4 m
	063754	072121	072145	072152	063792	040694	063761	063785	072138	063808	040748	046283	041486
	3 m						3 m	3 m			3 m	4 m	
	082151						063778	040687	043275	041462	040724	Carbon liner 040731	043282
	3 m						3 m	4 m			4 m	4 m	
	041424						040700	040946			040939	Carbon liner 040953	
	3 m						4 m	4 m					
	043268						040922	040557					
	3 m						3 m						
	043251						040540						

Anti-spatter spray (without silicone)

- Spray protecteur sans silicone
- Antihafspray (Ohne Silicon)

041806

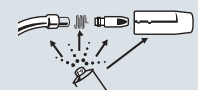

MIG torch stand with magnetic base

- Support torche magnétique

041653



CONSUMABLES - Consommables

Gas nozzles - Buses - Düsen - Tubo - Nippel - Bicos

A	B	C	D	E
Conical nozzle - Buse conique - Konische Düse	Spot welding - Pointage - Punktöse	Nail welding - Soude clou - Nagelschweißdüse	Special No Gas (isolated) - Isolée spéciale Sans gaz	Conical nozzle - Buse conique - Konische Düse

Torch liners - Gains
- Mantel - Funda
- Drahtseelen - Folha
(p. 103)

Tip adaptors & diffusers
- Supports tube contact & diffuseurs

A1	B1	C1	D1	A2	B2	C2	D2

Contact tips - Tubes contacts
- Kontaktröhre - Tubo de contacto
- Contactbuis - Pontas de contacto

A	B	C

Tip adaptors & diffusers - Supports tube contact & diffuseurs

	Steel/Stainless steel - Acier / Inox - Stahl/Edelstahl				ALU - Aluminium - Aluminio				PUSH PULL		SPOOL GUN
	AIR		LIQUID		AIR		LIQUID		AIR		AIR
	150 A	250 A	350 A	300 A	150 A	250 A	350 A	300 A	150 A	250 A	150 A
	A1 (x5) 042902	B1 (x5) 042995	D1 (x3) 043008	C1 (x3) 043589	A1 (x5) 042902	B1 (x5) 042995	D1 (x3) 043008	C1 (x3) 043589	A1 (x5) 042902	B1 (x5) 042995	A1 (x5) 042902
	A2 (x10) 042988	B2 (x5) 042919	D2 (x5) 042926	C2 (x5) 043541	A2 (x10) 042988	B2 (x5) 042919	D2 (x5) 042926	C2 (x5) 043541	A2 (x10) 042988	B2 (x5) 042919	A2 (x10) 042988

Contact tips - Tubes contacts - Kontaktröhre - Tubo de contacto - Contactbuis - Pontas de contacto

	150 A	250 A	350 A	300 A	150 A	250 A	350 A	300 A	150 A	250 A	150 A
	A (x10) 041905	A (x10) 041905	—	A (x10) 041905	—	—	—	—	—	—	—
	A (x10) 041912	B (x10) 041950	C (x10) 041790	B (x10) 041950	B (x10) 041059	A (x10) 041059	—	B (x10) 041059	B (x10) 041059	B (x10) 041059	B (x10) 041059
	A (x10) 041929	B (x10) 041967	C (x10) 419803	B (x10) 041967	B (x10) 041066	B (x10) 041066	C (x10) 419766	B (x10) 041066	B (x10) 041066	B (x10) 041066	B (x10) 041066
	A (x10) 040144	B (x10) 041974	C (x10) 419810	B (x10) 041974	B (x10) 041073	B (x10) 041073	C (x10) 419773	B (x10) 041073	B (x10) 041073	B (x10) 041073	B (x10) 041073
	—	—	C (x10) 419827	—	—	—	—	—	—	—	—
	—	—	C (x10) 419834	—	—	—	C (x10) 041080	—	—	—	—
	—	—	C (x10) 040533	—	—	—	—	—	—	—	—

Gas nozzles - Buses - Düsen - Tubo - Nippel - Bicos

	150 A	250 A	350 A	300 A	150 A	250 A	350 A	300 A	150 A	250 A	150 A		
	53 mm ∅12 (x3) 041875	57 mm ∅15 (x3) 041882	84 mm ∅16 (x3) 041783	63.5 mm ∅12 (x3) 043534	53 mm ∅12 (x3) 041875	53 mm ∅16 (x3) 046214	57 mm ∅15 (x3) 041882	84 mm ∅16 (x3) 041783	63.5 mm ∅12 (x3) 043534	63.5 mm ∅17 (x3) 046221	53 mm ∅12 (x3) 041875	57 mm ∅15 (x3) 041882	53 mm ∅12 (x3) 041875
	53 mm (x1) 041851	—	—	—	—	—	—	—	—	—	—	—	—
	53 mm (x1) 041523	—	—	—	—	—	—	—	—	—	—	—	—
	(x1) 041868	—	—	—	—	—	—	—	—	—	—	—	—
	(x1) 043084	(x1) 040571	(x1) 040588	—	—	—	—	—	—	—	—	—	—

Boxes

- Coffrets - Verschleißteilebox
- Cajas - Kistjes - Estojos

	M6 - 0.6 x 5 M6 - 0.8 x 5 Alu - M6 - 0.8 x 5		x 3		x 5		x 3	=	MB 15 (150 A) 041226
	M6 - 0.6 x 5 M6 - 0.8 x 5 Alu - M6 - 0.1.0 x 5		x 5		x 5		x 3	=	MB 15 / MB 25 077089
	M6 - 0.8 x 5 M6 - 0.1.0 x 5 Alu - M6 - 0.1.0 x 5		x 5		x 3		x 3	=	MB 25 (250 A) 041233
	M6 - 0.1.0 x 5 M6 - 0.1.2 x 5 Alu - M6 - 0.1.0 x 5 Alu - M6 - 0.1.2 x 5		x 5		x 3		x 2	=	MB 36 (350 A) 041417



CONSUMABLES - Consommables

TORCH LINERS - Gainses - Mantel - Funda - Drahtseelen - Folha

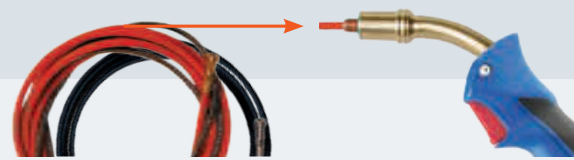

STEEL - Acier - Stahl - Acero - Staal - Aço			
Ø 0.6 / 0.8	3 m	041592	
	4 m	041837	
Ø 1.0 / 1.2	3 m	041608	
	4 m	041844	
	5 m	062276	
Ø 1.2 / 1.6	3 m	418417	
	5 m	062283	
Ø 1.6 / 2.4	4 m	040526	
	5 m	062290	

TEFLON			
Ø 0.6 / 0.8	3 m	041578	
	4 m	044050	
Ø 1.0 / 1.2	3 m	041585	
	4 m	044067	
	8 m	038677	
Ø 1.2 / 1.6	4 m	044074	



Guide gaine téflon pour motodévidoir 079601

CARBON			
Ø 0.6 / 0.8	4 m	039834	
	5 m	062306	
Ø 1.0 / 1.2	4 m	039827	
	5 m	062313	
Ø 1.2 / 1.6	4 m	039810	

PUSH PULL TORCH

Ø 1.0 / 1.2	8 m	038172
-------------	-----	--------

ROLLERS - Galets - Vorschubrollen - Rollen - Rodillos - Wielen - Roletes

TYPE A

For : Carmig



Steel, Stainless steel - Acier, Inox	Ø 0.6 / 0.8	x1	042339
	Ø 0.8 / 1.0	x1	041189
Alu	Ø 0.8 / 1.0	x1	041196
	Ø 0.8 / 0.9	x1	046856
Cored wire - Fil fourré	Ø 0.9 / 1.2	x1	042346



TYPE B

For : Autopulse 220, Autopulse 320-T1, M1 GYS Auto, M3 GYS auto, T1 GYS Auto, T3 GYS Auto, E1/E2/E3 GYS Auto



Steel, Stainless steel - Acier, Inox	Ø 0.6 / 0.8	x1	042087
	x2	042353	
Alu	Ø 0.8 / 1.0	x1	042100
	x2	042360	
Cored wire - Fil fourré	Ø 1.0 / 1.2	x1	042179
	x2	046849	
Alu	Ø 1.2 / 1.6	x2	042384
	x1	042155	
Cored wire - Fil fourré	Ø 0.8 / 1.0	x2	042377
	x1	042186	
Alu	Ø 1.0 / 1.2	x2	040915
	x2	042391	
Cored wire - Fil fourré	Ø 1.2 / 1.6	x2	042391
	x1	042131	
Alu	Ø 0.9 / 1.2	x2	042407

TYPE C

For : Neopulse - Autopulse 320-T3



Steel, Stainless steel - Acier, Inox	Ø 0.6 / 0.8	x2	041738
	Ø 0.8 / 1.0	x2	042094
Alu	Ø 1.0 / 1.2	x2	042117
	Ø 1.2 / 1.4	x2	039780
Cored wire - Fil fourré	Ø 1.2 / 1.6	x2	041752
	Ø 0.8 / 1.0	x2	042148
Alu	Ø 1.0 / 1.2	x2	042162
	Ø 1.2 / 1.6	x2	041776
Cored wire - Fil fourré	Ø 0.9 / 1.2	x2	042124

NO GAS WELDING KIT Ø 0.9 - Kit soudage sans gaz Ø 0.9

041240

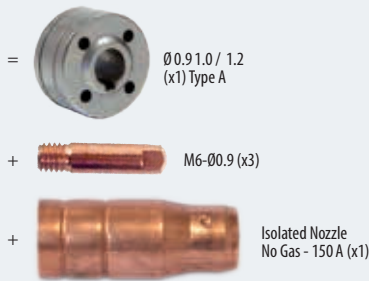
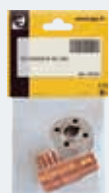

For : Easymig 150/160/160XL Smartmig 142/152/162/3P/182/183, Multiplearl 200-2

GAS CONNECTORS - Raccords gaz - Gasanschlüsse



SPECIAL MIG-MAG PLIER - Pince spéciale MIG/MAG - Spezial MIG/MAG Zange - Pinza especial MIG/MAG

PRO (x1)
041332

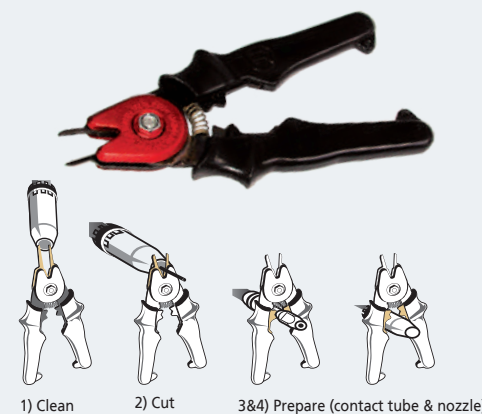

Anti-spatter spray (without silicone)
- Spray protecteur sans silicone
- Antihafespray (Ohne Silikon)

041806

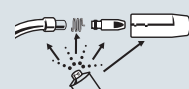

Torch gas flow-meter
- Débitmètre de bout de torche

053939



WELDING WIRE REELS - Bobines de fil - Drahtrollen - Rollos de hilo - Draadbobbijn - Bobines de fio

100 mm

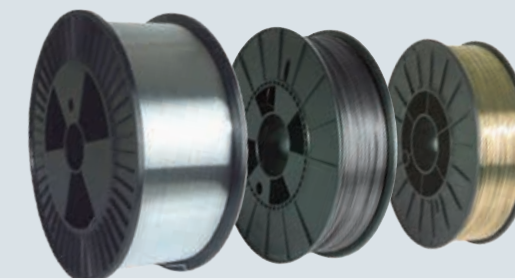

ECO
Ecological wire reel - Bobine écologique

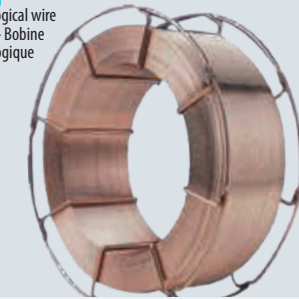

STEEL - Acier - Stahl - Acero - Staal - Aço

SG2

Norms : AWS 5.18 : ER 70S-6 ; EN ISO 14341-A : G46 4MG3S1 ; DIN 8559 : SG2

100 mm 0.9 kg	Ø 0.6	086593
	Ø 0.8	086609
200 mm 5 kg	Ø 0.6	086111
	Ø 0.8	086128
	Ø 1.0	086135
300 mm 15 kg	Ø 0.6	086166
	Ø 0.8	086227
	Ø 0.8 ECO	086272
EXCELLIUM 15 kg	Ø 1.0	086234
	Ø 1.0 ECO	086289
	Ø 1.2	086241
EXCELLIUM 15 kg	Ø 1.2 ECO	086296
	Ø 1.0 ECO	086302
EXCELLIUM 15 kg	Ø 1.2 ECO	086319

SG1

Norms : AWS 5.18 : ER 70S-3 ; EN ISO 14341-A : G42 2MG2S1 ; DIN 8559 : SG1

200 mm 5 kg	Ø 0.6	086418
	Ø 0.8	086401

CrMo2Si

Norms : AWS 5.28 : ER 90S-B3 ; EN ISO 2195L-A : Cr CrMo2Si

300 mm 15 kg	Ø 0.8	086258
-----------------	-------	--------

UHSS

Norms : AWS ASME SFA-5.28 : ER 120 S-G ; EN ISO 12534 : G Mn4Ni2, 5CrMo

200 mm 5 kg	Ø 0.8	086203
----------------	-------	--------

Hardfacing - Rechargement Acier 60 HRC

Norms : EN 14700 : TZ Fe 2 ; DIN 8555 : MSG 6-CF-60

300 mm 16 kg	Ø 1.2 ECO	086173
-----------------	-----------	--------

Cored wire - Fil fourré - Fülldraht - Hilo tubular

Norms : AWS 5.20 : E71T-G5 ; EN ISO 17632-A T42 Z W N 1 H15

100 mm 0.9 kg	Ø 0.6	086425
	Ø 0.9	086104
200 mm 4.5 kg	Ø 0.9	086265
	Ø 1.0	086623
300 mm 15 kg	Ø 1.2	086630
	Ø 1.0	086388
	Ø 1.2	086395

Galva (G2Ti)

Norms : AWS 5.18 : ER 70S-2 ; EN ISO 14341-A : G42 2 M G2Ti ; DIN 8559 : SG2

200 mm 5 kg	Ø 0.6	086760
	Ø 0.8	086777

BRAZING - Brasage

CuAl8 HLE - UHTS (Boron Steel)

Norms : AWS 5.7 : ER CuAl-A1 ; EN ISO 14640 : S Cu 6100 ; DIN 1733 : SG-CuAl8

200 mm 2 kg	Ø 0.8	077409
200 mm 5 kg	Ø 0.8	086661
	Ø 1.0	086197
300 mm 15 kg	Ø 1.0	086180

CuSi3 HLE - UHTS (Boron Steel)

Norms : AWS 5.7 : ER CuSi-A ; EN ISO 14640 : S Cu 6560 ; DIN 1733 : SG-CuSi3

100 mm 1 kg	Ø 0.8	086692
200 mm 2 kg	Ø 0.8	077393
200 mm 5 kg	Ø 0.8	086647
	Ø 1.0	086654
EXCELLIUM 5 kg	Ø 0.8	086210

STAINLESS STEEL - Inox - Edelstahl

CrNi (316LSi)

Norms : AWS 5.9 : ER 316L Si ; EN ISO 14343-A : G19 12 3 L Si ; DIN 8556 : SG X2 CrNiMo 19 12

200 mm 5 kg	Ø 0.8	086326
	Ø 1.0	086364
300 mm 15 kg	Ø 1.0	086371

CrNi (308LSi)

Norms : AWS 5.9 : ER 308L Si ; EN ISO 14343-A : G19 9 L Si ; DIN 8556 : SG X2CrNi 19 9

100 mm 1 kg	Ø 0.8	086616
200 mm 5 kg	Ø 0.8	086579
	Ø 1.0	086340
300 mm 15 kg	Ø 1.0	086357

ALUMINIUM

AlSi5

Norms : AWS 5.10 : ER 4043 ; EN ISO 18273 : S Al 4043-A ; DIN 1732 : SG-AlSi5

100 mm 0.5 kg	Ø 0.8	086685
200 mm 2 kg	Ø 1.0	086142
	Ø 1.2	086159

AlSi12

Norms : AWS 5.10 : ER 4047 ; EN ISO 18273 : S Al 4047 ; DIN 1732 : SG-AlSi12

100 mm 0.5 kg	Ø 0.8	086678
200 mm 2 kg	Ø 0.8	077140
	Ø 1.0	086067
300 mm 7 kg	Ø 1.2	086074
	Ø 1.2	086043

AlSi10Cu4

Norms : AWS 5.10 : ER 4145 ; EN ISO 18273 : S Al 41

200 mm 2 kg	Ø 1.2	073432
----------------	-------	--------

AlMg5

Norms : AWS 5.10 : ER 5356 ; EN ISO 18273 : S Al 5356 ; DIN 1732 : SG-AlMg5

100 mm 0.5 kg	Ø 0.8	086548
200 mm 2 kg	Ø 0.8	086555
	Ø 1.0	086562
300 mm 7 kg	Ø 1.0	086524
	Ø 1.2	086531
EXCELLIUM 7 kg	Ø 1.0 ECO	086487
	Ø 1.2 ECO	086494

After sales

Professional 71608



Industrial 71613

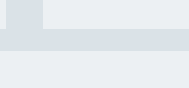

AlMg2.7Mn

Norms : AWS 5.10 : ER 5554 ; EN ISO 18273 : S Al 5554 ; DIN 1732 : SG-AlMg

200 mm 2 kg	Ø 1.2	086517
300 mm 7 kg	Ø 1.2	086500

Thickness measurement tools (x3)
- Jauges d'épaisseur (x3)
- Dickenessgeräte (x3)
071414

0.6 x 8 mm





PLASMA CUTTING

EASYCUT K	101
EASYCUT	102
CUTTER	103



PLASMA

COMPRESSOR INSIDE • 1~



EASYCUT K25

230 V • 1 ~ 25 A Fe 8 mm
Al/CrNi 6 mm

P400 COMPRESSOR

TPT 25, 4 m 068087 2 m, 10 mm²
068063

Youtube



ULTRA LIGHT & COMPACT
INTEGRATED AIR FILTER + AUTOMATIC DRAIN



EASYCUT K35 PFC

230 V • 1 ~ 35 A Fe 15 mm
Al/CrNi 10 mm

P400 PFC AD COMPRESSOR

TPT35, 4 m 080775 2 m, 10 mm²
080768

TPT35, 4 m 2 m, 10 mm² Box TPT35 080782 UNIVERSAL 800 051331
080805

OPTIONS

Consummables

					Boxes - Coffrets
for TPT25	x4 040236	x10 040212	x2 040175	x10 040168	039971
	x1	x1	x1	x1	
for TPT35	x4 040182	x10 080799	x2 040175	x10 040168	080782
	x1	x1	x1	x1	



	MADE IN FRANCE	CE NORM EN60974-1	50/60 Hz	I ₂ A	mm		INTEGRATED TECHNOLOGY					AIR SYSTEM			EN 60974-1 (40°C)			LxWxH cm / kg	Protected & compatible power generator (+/-15%)					
					Coupe max Severance cut	Coupe propre Clean cut	P400	PFC	AD	IP23	COMPRESSOR	min	ideal	max	I 60%	X% I2 max	100%		6.5 kW	7.5 kVA				
EASYCUT K25			230V 1~	16	10 → 25	8	6	6	4	■	—	—	—	■	included				15 A	35%	—	53 x 31 x 48 / 19	6.5 kW	7.5 kVA
EASYCUT K35 PFC			230V 1~	16	10 → 35	15	10	10	8	■	■	■	■	■	included				26 A	30%	—	45 x 26 x 36 / 27	8 kW	10 kVA



GYS

INVEST IN THE FUTURE



INDUCTION HEATING

1 200 - 22 000 kW

GYSDUCTION 106

COMBIDUCTION 107

POWERDUCTION 108

ACCESSORIES & CONSUMABLES 112



INDUCTION HEATING

CAR BODY

PFC POWER FACTOR CORRECTION

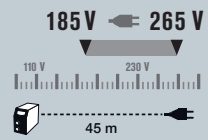

Youtube



	PACKS - GYSDUCTION AUTO									
	PROLINER AUTO 048775	COMPLETE AUTO 053380	COMPLETE AUTO+ 056978	MECA AUTO 048812	MECA AUTO+ 056961	BODY SHOP AUTO 048799	GLASS AUTO 048805	DENT REPAIR AUTO 054981	SMART REPAIR AUTO 079847	
GYSDUCTION AUTO	✓	✓	✓	✓	✓	✓	✓	✓	✓	✓
Plastic wedges 051294	✓	✓	✓	—	—	✓	✓	—	✓	—
Burn off inductor 053373	✓	✓	✓	—	—	✓	✓	—	✓	—
Body Inductor 053359	✓	✓	✓	—	—	✓	1 box	—	✓	—
Bolt Inductor 053366	✓	✓	✓	✓	✓	—	—	—	—	—
Remote control 055490	✓	✓	✓	✓	✓	✓	—	—	✓	—
Universal 800 051331	✓	1 box	—	1 box	—	—	—	—	—	—
Cable support 052284	✓	—	—	—	—	—	—	—	—	—
Dent pulling Inductor 054776	3 boxes	—	—	—	—	✓	✓	—	—	—
Spiral inductor 054783	—	✓	—	✓	—	1 box	1 box	—	✓	1 box



GYSDUCTION AUTO
2 400 W 230 V • 1 ~
 PFC AIR

CONSUMABLES

for	for	for
Protection (x5) + Colle - Stick 053854	Protection (x1) + Colle - Stick 059108	Protection (x10) + Colle - Stick 053847

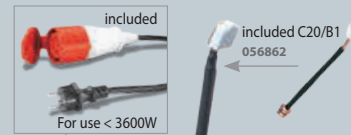

COMBIDUCTION AUTO 50LG
5 200 W 230 V • 1 ~
 PFC LIQUID
 065901



INCLUDED COMBIDUCTION

- Glass - Décapage - Entfernen 053373
- Decal - Décollage - Entkleben 053359

OPTIONS

- Spiral inductor - Inducteur spirale - Spiralinduktor 054783 (1.2 kW, 2.5 m)
- 800 mm 054813
- 800 mm 054868
- SIDE: Ø 18 mm ≤ M8 054806, Ø 24 mm ≤ M12 054790, Ø 30 mm ≤ M16 055469

Complete with - Complétez avec - Vervollständigen mit :

- SIDE: Ø 21 mm ≤ M10 079953, Ø 27 mm ≤ M14 079960
- FRONT: Ø 18 mm ≤ M8 079977, Ø 21 mm ≤ M10 079984, Ø 24 mm ≤ M12 079991, Ø 27 mm ≤ M14 080003, Ø 30 mm ≤ M16 080010

PDR : Paintless Dent Repair - Débosselage sans peinture - Lackschadenfreies Ausbeulen 054776

Licensed by BETAG innovation

3 m

Freezer spray - Spray refroidisseur -50 °C 400 ml (x 12) 048898

Adhesive for logo (x10) 051492

EN-60335/1	MADE IN FRANCE	A	W	kHz	Tech.	PFC	Liquid Cooling	Cable L (m)		Heating			LxWxH cm / kg	LxWxH cm / kg	Protected & compatible power generator (+/-15%)
								Inductor	Inductor	Heating	Heating	Heating			
GYSDUCTION AUTO	230V, 1~, 50/60 Hz	16 mini	2400	35+100	■	—	—	2	2.5	M10 → 1 s	2 mm → 5 s	Ø8 → 10 s	37 x 21 x 37 / 7.5	52 x 30 x 37 / 12.9	3 kW
COMBIDUCTION AUTO 50LG	230V, 1~, 50/60 Hz	25 mini	5200	20+80	■	■ 71	■	8	3	M14 → 1 s	2 mm → 3 s 4 mm → 5 s	Ø10 → 10 s	46 x 43 x 75 / 60	v	6 kW



INDUCTION HEATING

1.2 → 5.2 kW

MAINTENANCE / MECHANIC / INDUSTRY

	10R	10R PRO
POWERDUCTION 10R	✓	✓
Flexible 800 mm 054813	✓	✓
Straight 800 mm 054868	✓	✓
SIDE		
Ø 18 mm ⊙ ≤ M8 054806	✓	✓
Ø 21 mm ⊙ ≤ M10 079953	✓	✓
Ø 24 mm ⊙ ≤ M12 054790	✓	✓
Ø 27 mm ⊙ ≤ M14 079960	✓	✓
Ø 30 mm ⊙ ≤ M16 055469	✓	✓
FRONT		
Ø 18 mm ⊙ ≤ M8 079977	✓	✓
Ø 21 mm ⊙ ≤ M10 079984	✓	✓
Ø 24 mm ⊙ ≤ M12 079991	✓	✓
Ø 27 mm ⊙ ≤ M14 080003	✓	✓
Ø 30 mm ⊙ ≤ M16 080010	✓	✓



	included	37LG S90	37LG S180/B3W
S90 058927	✓	✓	—
S180/B3W 067899	—	—	✓



1200 W | 230V • 1~ | AIR

POWERDUCTION 10R
(5 inductors)
062504
068643
080966

POWERDUCTION 10R PRO
(12 inductors)
080195
080300

POWERDUCTION 37LG (S90) | POWERDUCTION 37LG (S180/B3W)

3700 W | 230V • 1~ | * LIQUID
056992 | 080195 | 072510 | 080959

3700 W | 230V • 1~ | * LIQUID
083387 | 083394

NEW

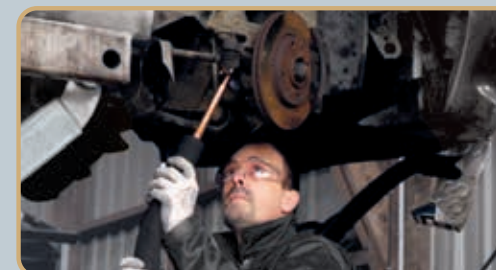
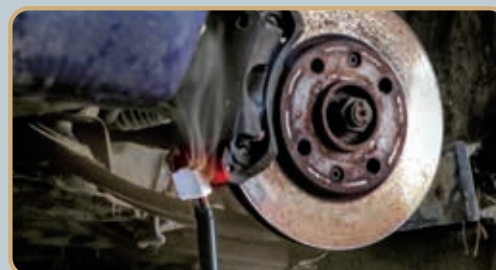

	included	39LG C20/B1	39LG S90
C20/B1 056862	✓	✓	—
28S 064485	—	—	✓
S90 058927	—	—	✓

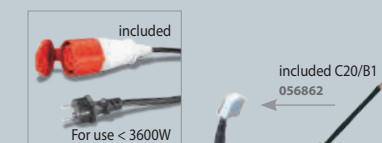

READY TO USE
Liquid included

READY TO USE
Liquid included

POWERDUCTION 39LG (C20/B1) | POWERDUCTION 39LG (S90)

3700 W | 230V • 1~ | * LIQUID
058583

3700 W | 230V • 1~ | * LIQUID
080027

POWERDUCTION 50LG

5200 W | 230V • 1~ | * LIQUID
055599

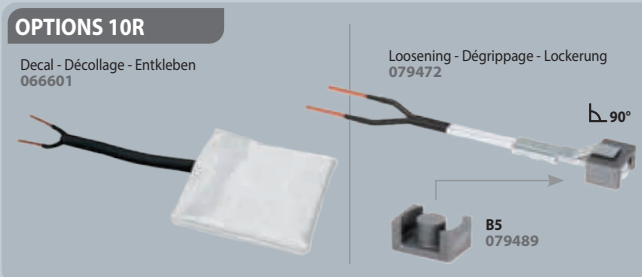

MADE IN FRANCE	A	W	Freq. kHz	INTEGRATED TECHNOLOGY		Liquid Cooling	Cable L (m)	Heating			Protected & compatible power generator (+/-15%)	L × W × H cm / kg	L × W × H cm / kg		
				P400	PFC			Inductor	Heating	Heating					
POWERDUCTION 10R / 10R PRO	230V, 1~ / 50/60 Hz	10 mini	1200	45+80	—	—	2	1.5	M10 → 1s	2 mm → 5 s	Ø8 → 10 s	1.5 kW	062504 - 42 × 17 × 37 / 5.4	062504 - 21 × 10 × 15 / 3.3	
POWERDUCTION 37LG	230V, 1~ / 50/60 Hz	16 mini	3700	15+30	—	—	2	2	M10 → 1s	2 mm → 5 s	Ø10 → 15 s	4 kW	60 × 34 × 33 / 14.5	56 × 26 × 29 / 13	
POWERDUCTION 39LG (C20/B1) / (S90)	230V, 1~ / 50/60 Hz	16 mini	3700	20+60	■	■	71	6	3	M12 → 1s	2 mm → 5 s	Ø10 → 15 s	4 kW	058583 - 81 × 38 × 59 / 52	058583 - 46 × 36 × 70 / 46.5
POWERDUCTION 50LG	230V, 1~ / 50/60 Hz	25 mini	5200	20+60	■	■	71	8	3	M14 → 1s	2 mm → 3 s / 4 mm → 5 s	Ø10 → 10 s	6 kW	80 × 60 × 60 / 71	46 × 43 × 75 / 58



INDUCTION HEATING 11 → 22 kW

NEW

included	110LG L90	110LG L20/B4
32L	064515	✓
L90	059788	✓
L20/B4	067882	✓



READY TO USE
Liquid included

POWERDUCTION 110LG (L90)	POWERDUCTION 110LG (L20/B4)
11 000 W 400 V • 3~	11 000 W 400 V • 3~
* LIQUID	* LIQUID
058590	083400

POWERDUCTION 110LG (L90) 208-240V
11 000 W 208-240 V • 3~
* LIQUID
065246

NEW

included	160LG L90	160LG L20/B4
32L	064515	✓
L90	059788	✓
L20/B4	067882	✓



READY TO USE
Liquid included

POWERDUCTION 160LG (L90)	POWERDUCTION 160LG (L20/B4)
16 000 W 400 V • 3~	16 000 W 400 V • 3~
* LIQUID	* LIQUID
057814	083417

POWERDUCTION 160LG (L20/B4) 208-240 V
16 000 W 208-240 V • 3~
* LIQUID
065253

included adapter
32L + L20/B4
064515 + 067882



READY TO USE
Liquid included

POWERDUCTION 220LG
22 000 W 400 V • 3~
* LIQUID
6 m cable : 066861
10 m cable : 074576

OPTION

Powerduction 160/220 LG over hanging arm-pulley
- Équilibrer Powerduction 160/220 LG

079441



t° POWER HEAT CONTROLLER

t° CONTROL
80>350°C (210>660°F)



5,5m
POWER HEAT CONTROLLER
061644

Included
T° sensors
thermocouple type K
x2



Compatibility
POWERDUCTION 110LG
POWERDUCTION 110LG 208-240 V
POWERDUCTION 160LG
POWERDUCTION 160LG 208-240 V
POWERDUCTION 220LG

OPTION



Pyrometer IR
for inductor L90

1.1 m
064119

OPTIONS



Removable handle
- Poignée de lance
- Abnehmbarer Griff
for POWERDUCTION
110 - 160 - 220 LG
068599



Cooling liquid
for
POWERDUCTION

2 L 082212
5 L 062511
10 L 052246



Protection cover
- Housse de protection
- Schutzhaube
for
POWERDUCTION
160 - 220 LG
050853



Protection cover
- Housse de protection
- Schutzhaube
for
POWERDUCTION
110LG
062733



055490

MADE IN FRANCE	Cable L (m)	Freq.	Liquid Cooling	Cable L (m)	Heating	LxWxH cm / kg	LxWxH cm / kg	Protected & compatible power generator (+/-15%)					
									A	W	kHz	Inductor	Heating
POWERDUCTION 110LG	400 V, 3~, 50/60 Hz	16 mini	11 000	20+60	71	5	4	M18 → 1 s	2 mm → 2 s 4 mm → 4 s	Ø10 → 7 s	42 x 42 x 76 / 66.5	59 x 80 x 60 / 86	15 kW
POWERDUCTION 110LG 208-240V	208-240 V, 3~, 50/60 Hz	35 mini	11 000	20+60	71	5	4	M18 → 1 s	2 mm → 2 s 4 mm → 4 s	Ø10 → 7 s	42 x 42 x 76 / 78	59 x 80 x 60 / 90	15 kW
POWERDUCTION 160LG	400 V, 3~, 50/60 Hz	32 mini	16 000	20+60	301	4	6	M20 → 1 s	2 mm → 2 s 4 mm → 4 s	Ø10 → 5 s	78 x 58 x 118 / 128	80 x 61 x 120 / 140	22 kW
POWERDUCTION 160LG 208-240V	208-240 V, 3~, 50/60 Hz	45 mini	16 000	20+60	301	4	6	M20 → 1 s	2 mm → 2 s 4 mm → 4 s	Ø10 → 5 s	78 x 58 x 118 / 113.5	80 x 60 x 120 / 126	22 kW
POWERDUCTION 220LG	400 V, 3~, 50/60 Hz	32 mini	22 000	20+60	301	4	6	M45 → 3 s	4 mm → 3 s 8 mm → 9 s	Ø10 → 4 s	70 x 60 x 120 / 98	80 x 60 x 132 / 139	22 kW
POWERDUCTION 220LG 10M	400 V, 3~, 50/60 Hz	32 mini	22 000	20+60	301	4	10	M45 → 3 s	8 mm → 9 s 4 mm → 3 s	Ø10 → 4 s	70 x 60 x 120 / 132.5	80 x 60 x 120 / 144.5	22 kW

SMALL Ø16

INDUCTORS

* = original equipment	S90 058927	S70 061569	S180 059269	S20/B1 (20°) 064874	S180/B1 064881	S180/B3W 067899
37 LG	✓*		✓			✓
39 & 50 LG			✓ with adapter 28S			
110, 160 & 220 LG			✓ with adapter 32S			

	S20/D20 078796	S90/D20 078871	S180/D20 069985
Ø 20	S20/D25 078802	S90/D25 078888	S180/D25 069992
Ø 25	S20/D30 078819	S90/D30 078895	S180/D30 070592
Ø 30	S20/D35 078826	S90/D35 078901	S180/D35 070608
Ø 35	S20/D40 078833	S90/D40 078918	S180/D40 070615
Ø 40	S20/D45 078840	S90/D45 078925	S180/D45 070622
Ø 45	S20/D50 078857	S90/D50 078932	S180/D50 070639
Ø 50	S20/D55 078864	S90/D55 078949	S180/D55 070646
Ø 55			
37 LG	✓ S20/D20-D35, S90/D20-D35, S180/D20-D35		
39 & 50 LG	✓ with adapter 28S		
110, 160 & 220 LG	✓ with adapter 32S		
Protection kit for L180/D inductors - Kit de protection pour inducteurs boucle 077386			

	S180 HEAT TUBE D37 078604	S180 HEAT TUBE D40 078611	S180 HEAT TUBE D50 078628
39 & 50 LG	✓ with adapter 28S		
110, 160 & 220 LG	✓ with adapter 32S		

DIFFICULT ACCESS ADAPTERS	
	<ul style="list-style-type: none"> 90°-S 082663 ✓ compatible with 180/B1 ✓ compatible with 180/B2 ✓ compatible with 180/B3W

ADAPTERS	
	<ul style="list-style-type: none"> 28S M28 Ø16 064485 32S M32 Ø16 064508
39 & 50 LG	✓ 28S M28 Ø16
110, 160 & 220 LG	✓ 32S M32 Ø16

Boxes - Boîtes		
 28S/B type W for 39LG & 50LG 072497 included: S20/B1 (x1) S180/B1 (x1) S180/B3 (x1) 28S (x1) B1 (x1) B3 (x1)	 32S/B type W for 110LG, 160LG & 220LG 072503 included: S20/B1 (x1) S180/B1 (x1) S180/B3 (x1) 32S (x1) B1 (x1) B3 (x1)	 L box 065796 included: L70 (x1) L180 (x1)

Trolley for inductor for adapter 32L Chariot pour inducteur pour adaptateur 32L 075955

Ferrites - Ferrites - Ferritaufsatz										
 B1 053823	 B1 (x5) 079380	 B2 053458	 B3 067875	 B4 053755	 B5 079489	 B1 (x5) 079397	 B2 056916	 B3 072527	 B4 054844	 Spiral 069701

Glue kit for inductor Kit de colle pour inducteur 075948

LARGE Ø32

INDUCTORS

* = original equipment	L90 (90°) 059788	L70 (70°) 059771	L180 059795	L180/Spiral 065000	L20/B4 067882	L180/B4 079786	L20 Alu Glove 069114
39 & 50 LG	✓ with adapter 28L						
110, 160 & 220 LG	✓ with adapter 32L*		✓ with adapter 32L		✓ with adapter 32L*	✓ with adapter 32L	✓ with adapter 32L

Ø	Pre-heating - Préchauffe Heating - Chauffage	Pre-heating & Fretting - Préchauffage et Frettage		
		Ø 20°	Ø 90°	Ø 180°
Ø 60	✓	L20/D60 078956	L90/D60 079106	L180/D60 069923
Ø 70	✓	L20/D70 078963	L90/D70 079113	L180/D70 069930
Ø 80	✓	L20/D80 078970	L90/D80 079120	L180/D80 069121
Ø 90	✓	L20/D90 078987	L90/D90 079137	L180/D90 069947
Ø 100	✓	L20/D100 078994	L90/D100 079144	L180/D100 069954
Ø 110	✓	L20/D110 079007	L90/D110 079151	L180/D110 069961
Ø 120	✓	L20/D120 079014	L90/D120 079168	L180/D120 069978
Ø 130	✓	L20/D130 079021	L90/D130 079175	
Ø 140	✓	L20/D140 079038	L90/D140 079182	
Ø 150	✓	L20/D150 079045	L90/D150 079199	
Ø 160	✓	L20/D160 079052	L90/D160 079205	Production on request
Ø 170	✓	L20/D170 079069	L90/D170 079212	
Ø 180	✓	L20/D180 079076	L90/D180 079229	
Ø 190	✓	L20/D190 079083	L90/D190 079236	
Ø 200	✓	L20/D200 079090	L90/D200 079243	
39 & 50 LG		✓ with adapter 28L		
110, 160 & 220 LG		✓ with adapter 32L		

Protection kit for L180/D inductors - Kit de protection pour inducteurs boucle 077386	
--	--

ADAPTERS	 28L M28 Ø32 064492	 32L M32 Ø32 064515
39 & 50 LG	✓ 28L M28 Ø32	
110, 160 & 220 LG	✓ 32L M32 Ø32	

Pre-heating & Fretting - Préchauffage et Frettage			
	L90 BRAZ 16 Ø 1/2" / 16 mm 076907	L90 BRAZ 28 Ø 1" / 28 mm 076921	L180 BRAZ 16 Ø 1/2" / 16 mm 076914
			L180 BRAZ 28 Ø 1" / 28 mm 076938
* = original equipment			
110, 160 & 220 LG	✓ with adapter 32L		

Brasing - Brasage			
	L90 BRAZ 16 Ø 1/2" / 16 mm 076907	L90 BRAZ 28 Ø 1" / 28 mm 076921	L180 BRAZ 16 Ø 1/2" / 16 mm 076914
			L180 BRAZ 28 Ø 1" / 28 mm 076938
* = original equipment			
110, 160 & 220 LG	✓ with adapter 32L*		

Protection kit for BRAZ inductors - Kit de protection pour inducteurs brasage 077515	
---	--

Exchanger - Échangeur	
	L180R X Production on request
110, 160 & 220 LG	✓ with adapter 32L

COMPLETE Ø28

INDUCTORS

	C20/B1 056862	C180/B1 056879	C180/B2 056886
37 LG			
39 & 50 LG	✓*		✓
110, 160 & 220 LG			



TRUCK TOOLS & MOBILE LIFTS

TRUCK TOOLS

TROLLEY IW1	115
MULTITOOL TRUCK	115

CAR LIFTS

SPOT LIFT	116
NEW QUICK LIFT / AIR JACKS	118
ERGO LIFT	119
NEW MANUAL DOOR LIFT / WHEEL LIFT	120

TROLLEY IW1 / MULTITOOL TRUCK

TRUCK TOOLS

TROLLEY IW1
Impact wrench trolley -
Support de clé à choc

max 6.5 bar

max 20 kg

063136



OPTIONS



Huile hydraulique
- Hydraulic oil
1l
053397

**Weight, vibrations & torque suppression -
Suppression du poids,
des vibrations et du couple**



70 kg
95 cm
86 cm
86 cm
39 cm
75 kg
123 cm
79 cm

42°

90 cm (max)
30 cm (min)

Weight adjust
- Effort réglable

Impact wrench -
Clé à choc
max 20 kg

Fixation
36 x 36 mm
→ 44 x 44 mm

High dexterity -
Liberté de
mouvement

High maneuverability & stability -
Grande maniabilité et stabilité



115

TRUCK TOOLS



MULTITOOL TRUCK

SAFE EN 14238 + A1

max 200 kg

067158

INCLUDED



Lifting tool for brake caliper
- Outil de levage pour étrier
de frein - Hebewerkzeug für
Bremssattel

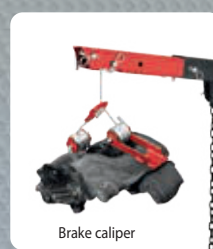

Brake caliper

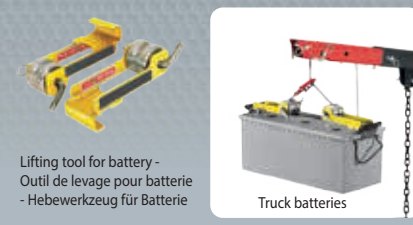

Lifting tool for battery -
Outil de levage pour batterie
- Hebewerkzeug für Batterie

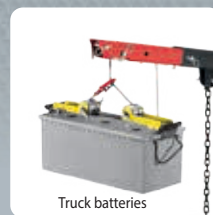

Truck batteries



Lifting tool for wheels -
Outil de levage pour roues
- Hebewerkzeug für Räder



SAFE EN 14238 + A1

90kg
103 > 186 cm
88.5 > 110 cm
101 > 130 cm
39 cm
95 kg
123 cm
79 cm

ULTRA COMPACT 103 cm

HEALTH CARE

90°



SPOT LIFT

MOBILE LIFTS

SPOT LIFT EASY

max Air 8 bar **SAFE EN 1494**
max 2.2 t

HEALTH CARE

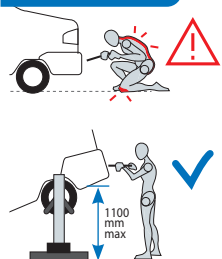

High stability - Haute stabilité

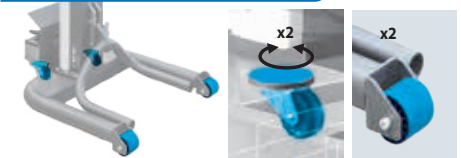

Included 220 bar 053588

SAFE EN 1494

SECURITY

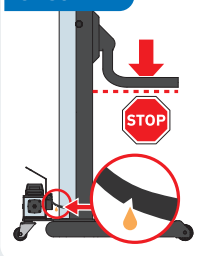

OPTIONS

Hydraulic oil 1L - Huile hydraulique 1L 053397



Rocker panel lifting tool - Outil de levage pour bas de caisse - Auflage für Seitenschweller 053236



84 kg 1.27 m 0.89m 0.76m 0.29m 1.23 m 0.79m 93 kg



SPOT LIFT PRO

max Air 8 bar **SAFE EN 1494**
max 2.2 t

053557

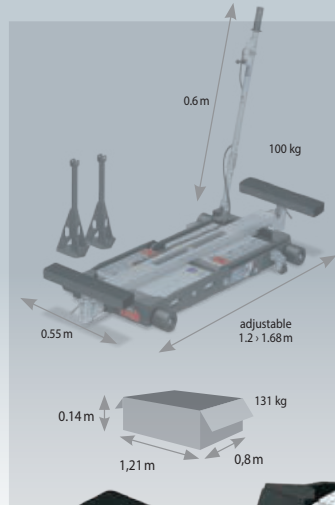

SPOT LIFT PRO MOB

max Air 8 bar **SAFE EN 1494**
max 2.2 t

055896

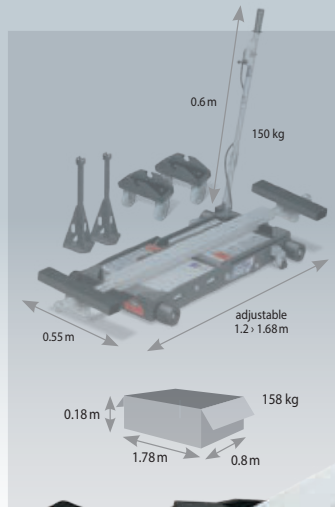

60 cm (max) 14 cm (min)

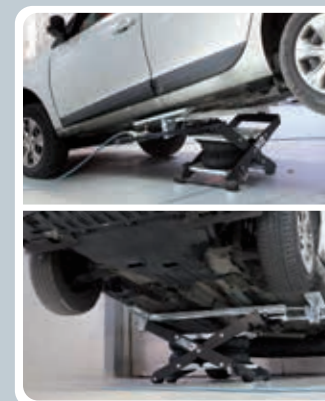
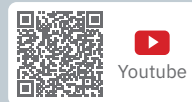

OPTIONS

Height adjuster for 4x4 & utility vehicles - Réhausseur pour 4x4 et utilitaires - Erhöhung f. 4x4 und Leicht-LKW



Pads - Patins for Audi & BMW (x 2) 053717

Ramps - Ramps 700 x 200 x 80 mm (x 2) 056787



OPTIONS

SPOT LIFT PRO MOB Réhausseur pour 4x4 et utilitaires - Height adjuster for 4x4 & utility vehicles - Erhöhung f. 4x4 und Leicht-LKW



Patins - Pads for Audi & BMW (x 2) 061606

Ramps - Ramps 700 x 200 x 80 mm (x 2) 056787

AUTO ROLL

min 500 mm max 1700 mm (AUTOROLL 1.0m) max 2240 mm (AUTOROLL 1.55m) 360° 2.5 t max

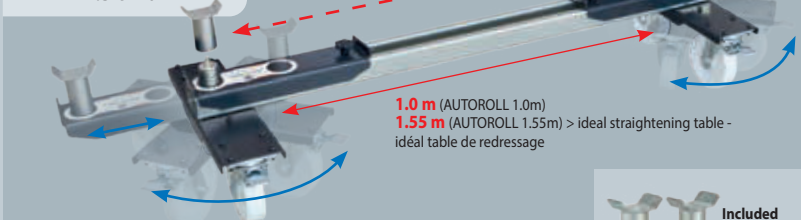

AUTO ROLL 1.0 m / 1.2 t 059047



AUTO ROLL 1.55 m / 1.2 t 063839



AFTER LIFT AUTO ROLL

1 2 360° 2.5 t max

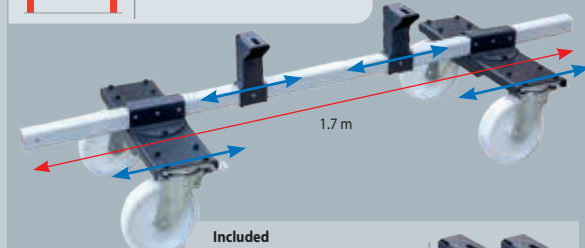

067967



WHEEL TROLLEYS - Tabourets de manutention - Radhocker

048768



MECHANICAL LIFTING JACKS - Chariots de manutention prise sous roue - Kfz-Montagelift, fahrbar

071995

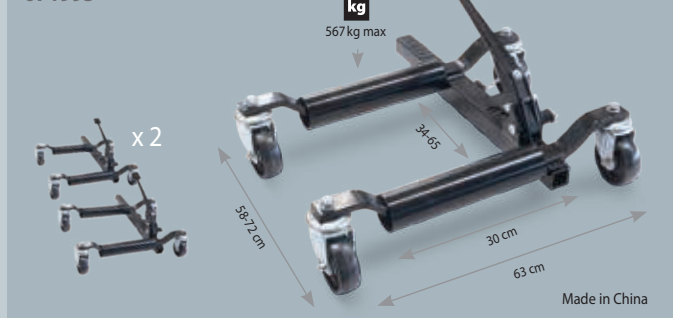

117

SPOT LIFT

MOBILE LIFTS

QUICK LIFT L520E

062184

220 V, 1 ph
0.75 kW

Included
Hydraulic oil 5 L
- Huile hydraulique
5 L
062160



10 cm
12 cm
5 cm
Pads - Patins
Included (x 8)

SAFE
EN 1493

2.5 t max

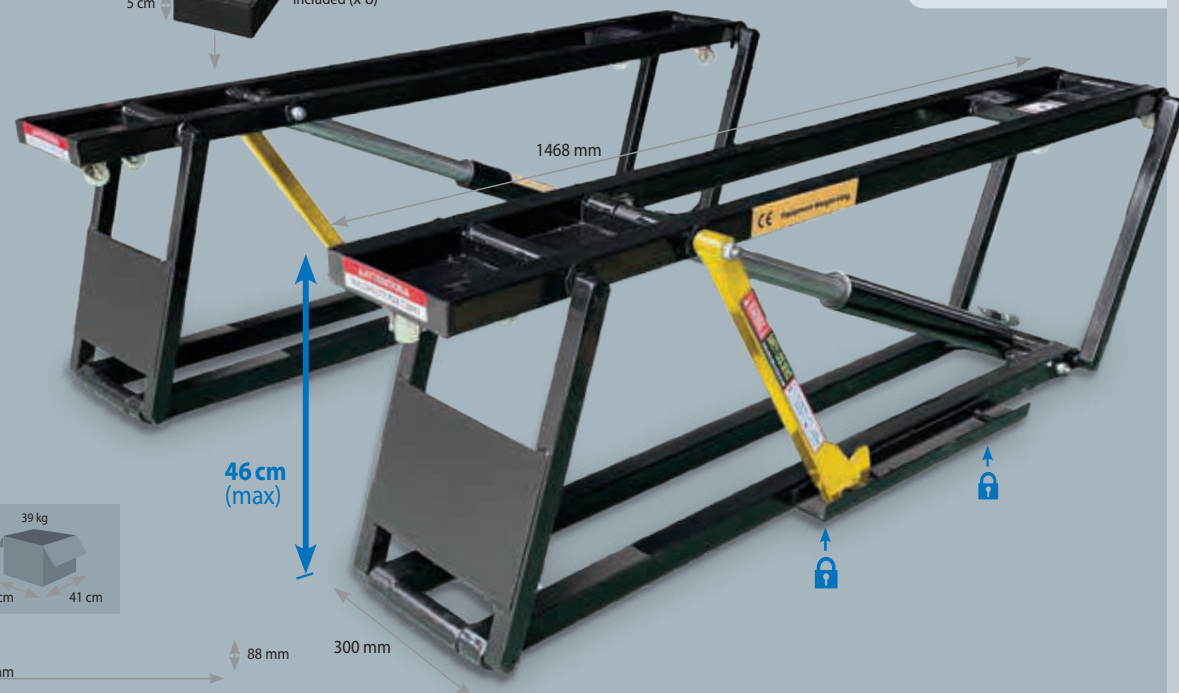

Made in China

OPTIONS

Extensions 1680 mm x 2
066328



x4 Patins à rainures
071933

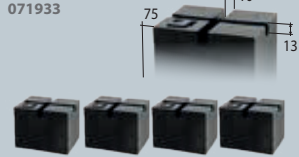

Pads for SUV x4 - Patins pour SUV x 4
065017



Wall mount -
Support mural
071926



AIR JACKS

DOUBLE BAG AIR JACK 082878

Pressure : 8 bar (116 PSI)
Weight 12 kg

60 x 52 x 14.5 cm
14.8 kg

SAFE
EN 1494

12 kg
LIGHT & COMPACT

TRIPLE BAG AIR JACK 082885

Pressure : 8 bar (116 PSI)
Weight 14 kg

62 x 56.5 x 18 cm
17.8 kg

SAFE
EN 1494

14 kg
LIGHT & COMPACT

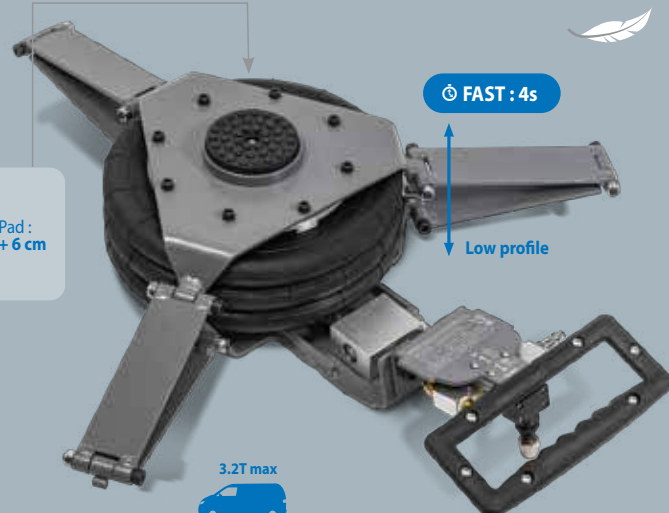
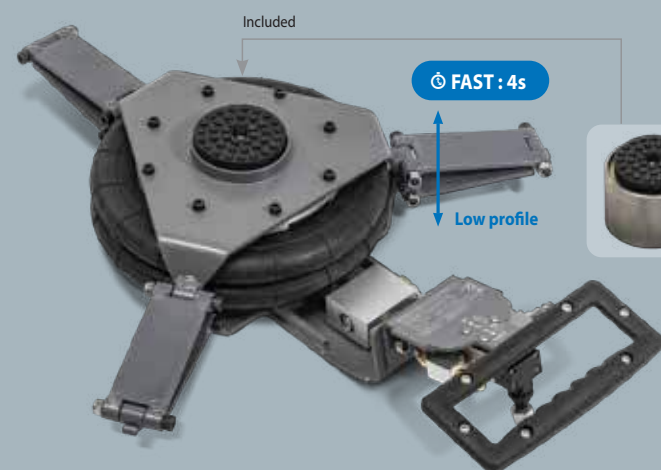

max : 40 cm (+ pad)
max : 34 cm
min : 12 cm
3T max

NEW
06/2024

STABILITY ✓

max : 49.5 cm (+ pad)
max : 43.5 cm
min : 14.5 cm

NEW
06/2024

STABILITY ✓

ERGO LIFT 1000 ROLL

Air 7-8 bars

SAFE
EN 1493

max 2.5 t

24 cm
437 kg
226 cm
115 cm

Ergo Lift
+ Wheels
+ Pump = 469 kg

High stability - Haute stabilité

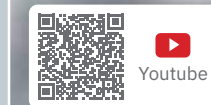

SAFE
EN 1493

included :
(x4) 4 cm + (x4) 6 cm

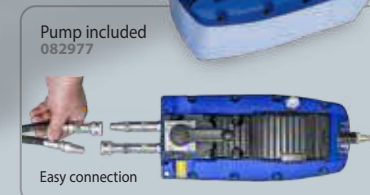
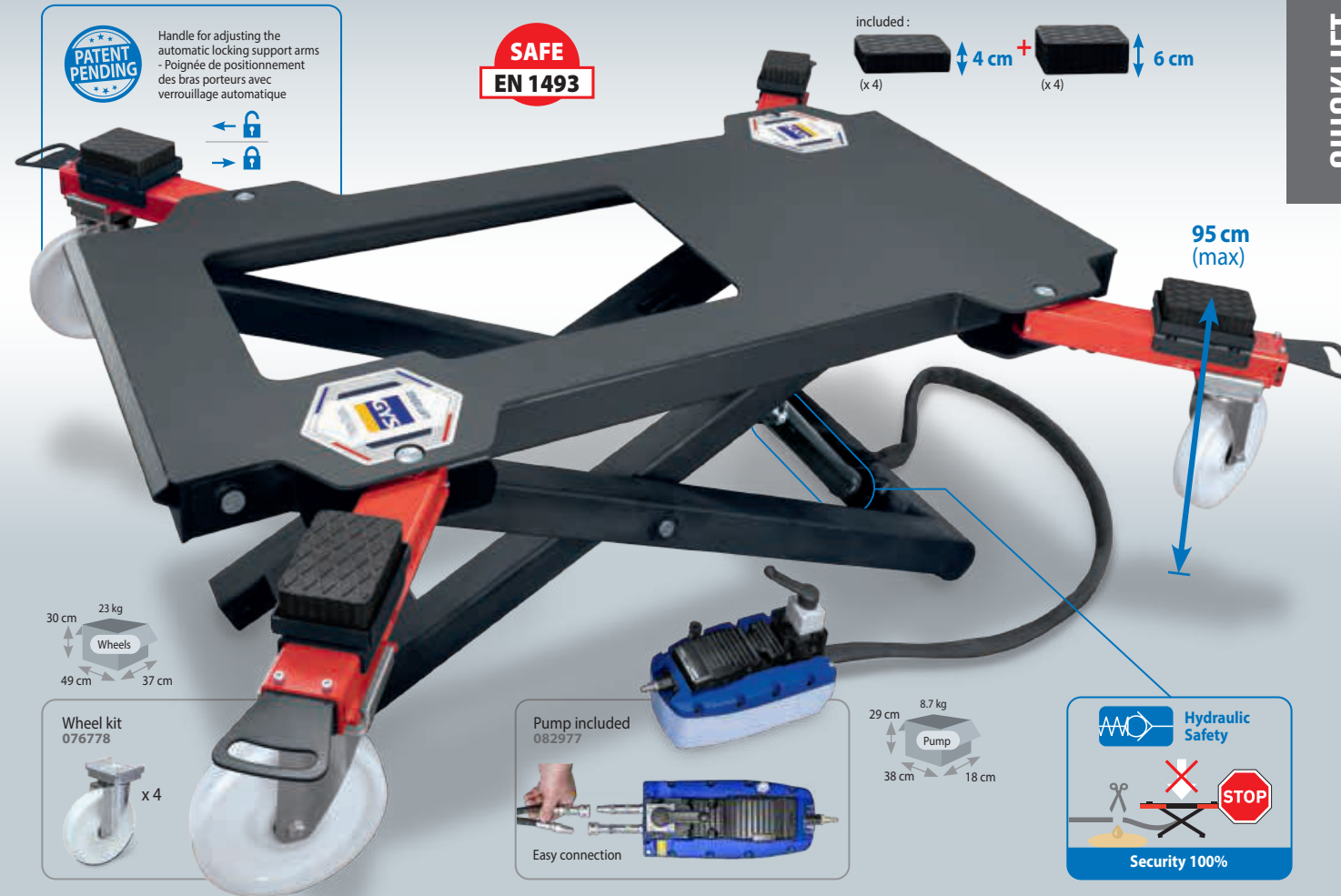

10 cm (min)

395 kg

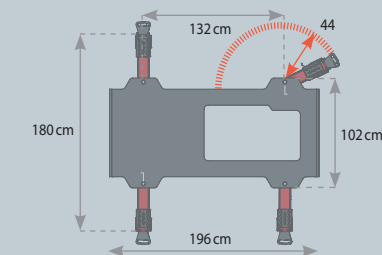

OPTIONS

Pads for SUV x4
- Patins pour SUV x 4
065017

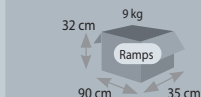
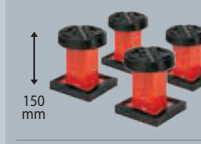

Ergo Lift ramps x2
- Rampes Ergo Lift x2
082717

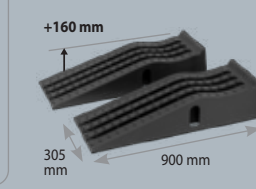

Capacity :
max 3.5 t

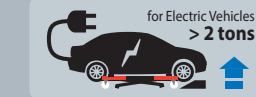

Pack ERGO LIFT 1000 ROLL + wheels

076792



Pack ERGO LIFT 1000 ROLL + wheels + ramps

082984



MANUAL DOOR LIFT

Ergonomic door handling trolley
 - Support Pro ergonomique de manutention de portière
 - Ergonomische Türhandhabungsunterstützung
 082670

Manufactured by GYS = SUPER PRO

117 x 28 x 27 cm
 40 kg

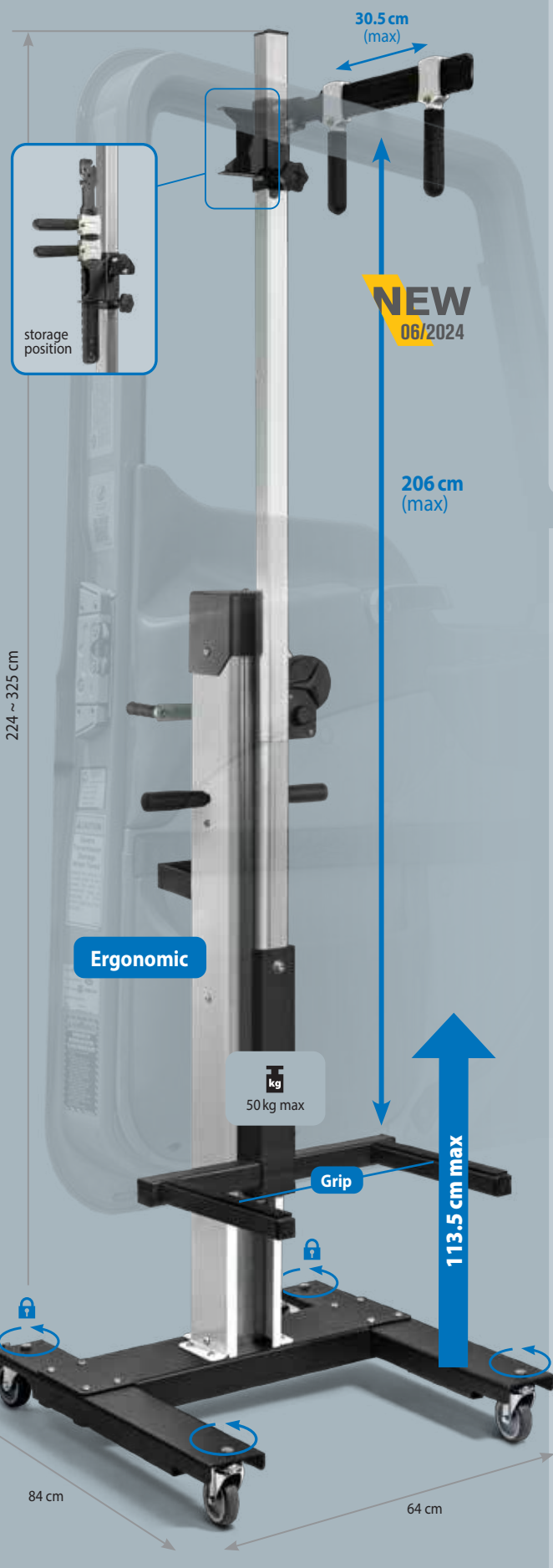

Option

Wide door accessory
 - Accessoire pour portière large
 - breites Türzubehör
 082700

NEW



MANUAL WHEEL LIFT

Wheel lift trolley
 - Lève roue à treuil
 - Radmontage-Heber
 061385

Manufactured by GYS = SUPER PRO

min: R13 / 135 / 65
 max: R22 / 300 / 35
 40 kg max

117 x 28 x 27 cm
 42 kg

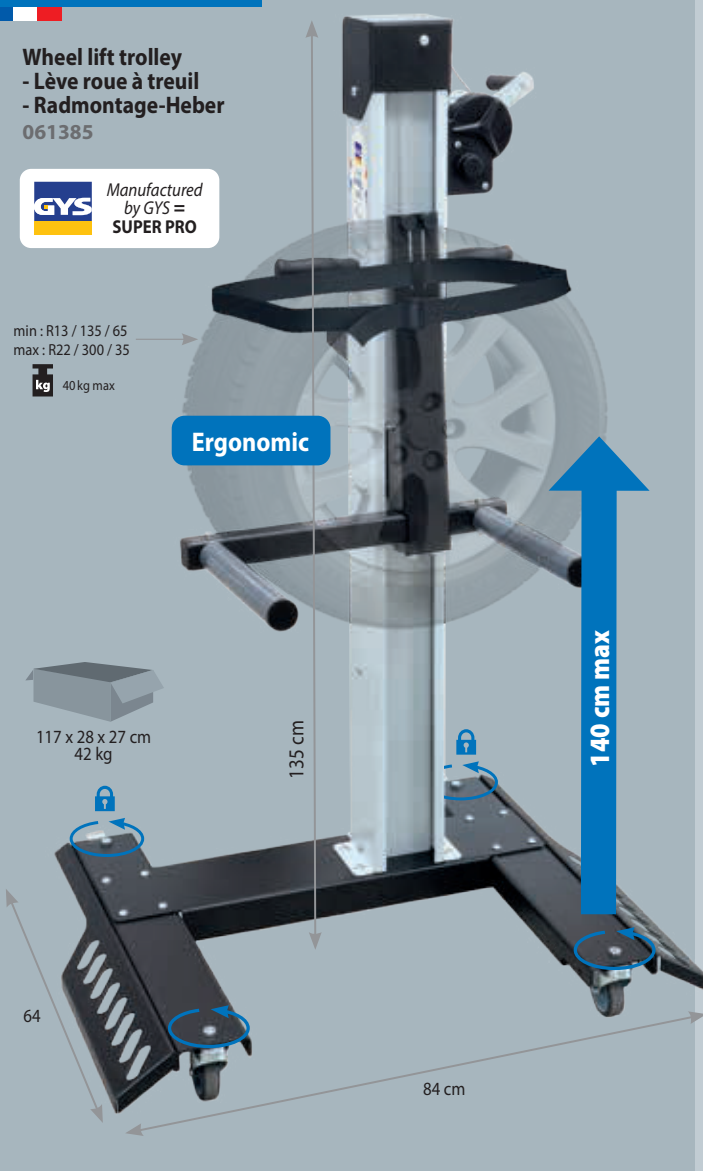

ACCESSORIES

WELDING HELMETS	122
FUME EXTRACTION	125
WINDSCREEN REPAIR	126
BUMPER REPAIR	128
HAND TOOLS	130
PNEUMATIC TOOLS	134
WORKING LIGHTS	136
SANDING & DUST EXTRACTION	138
WORKING SUPPORTS	140
ELECTRIC VEHICLES	144
SAFETY PROTECTION	146

HELMETS VENTILATED

IDEAL



DIGITAL MEMORY & REGULATIONS ELECTRONIC



GYSMATIC 3/9-13 G AIR
0465727
069602

100 x 60 mm

0.08 ms



GYSMATIC 5-13 G AIR XXL
047846
028852

100 x 83 mm

0.1 ms



included with GYSMATIC 5/13 G AIR XXL

Filtration class EN 12941: TH2 P R SL
Air 165 / 200
220 L/min
Battery included

OPTION Filter TH3
065734



Battery charger
037472
028869



Battery included
037465



038424 x1



038417 x5

LENSES - Verres - Schutzgläser

			TRUE COLOR	HF	DELAY								L x W x H cm / g	MASK BRAND
114 x 133 (x10)	043893	G: 106 x 66 (x10)	043886	GYSMATIC 3/9-13 G AIR	3-9>13	0.08 ms	✓	0.10>0.90 s	1/1/1/2	4 HIGH SENSITIVITY	XL: 100x60 mm	✓	28 x 25 x 28 / 1230	Gys
114 x 133 (x10)	043893	106 x 89,5 (x10)	046825	GYSMATIC 5-13 G AIR XXL	4-5>9 / 9>13	0.10 ms	✓	0.1 > 0.9 s	1/1/1/1	4 HIGH SENSITIVITY	XXL: 100x83 mm	✓	27 x 25 x 28 / 1000	Gys

FUME EXTRACTION SYSTEMS - Aspirateurs de fumée - Rauchgasabsauggerät

UNI 2.0 RE

- 400V 3~
- 50 Hz
- 1100 W
- 1500 m³/h max
- arm 3 m
- no plug
- 100 kg
- extraction 0.5 m/s

122 x 67 x 145 cm / 111.5 kg

061545



Ø 150 mm

Included
Pré filtre, treillis Aluminium
Class of filtration G3 EN 779
+ **Filtre - Coal Filter EPA E12**
EN 779, Filtration >99.5 %
046467

Options
Filtre à charbon actif - Coal filter
✓ UNI 2.0 RE
064522

EVO 2.1 RE

- 230V 1~
- 50 Hz
- 1100 W
- 1200 m³/h max
- occasional
- arm 3 m
- included
- 85 kg

96 x 95 x 162 cm / 114 kg

061552



Ø 150 mm

792 mm

347 mm

Patented - Breveté

Included
Pré filtre, treillis Aluminium
Class of filtration F15 G2 EN 779
+ **Filtre - Coal Filter HEPA H13**
EN 779, Filtration >99.95%
046498

FUME EXTRACTION TORCHES - Torches aspirantes - Rauchgas-Absaugbrenner - Antorcha con aspiración de humos

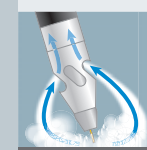

BINZEL

	Steel/Stainless steel - Acier/Inox - Stahl/Edelstahl			
	AIR		LIQUID	
	150 A	250 A	350 A	500 A
original equipment	M6	M6	M8	M8
Ø	Ø 0.8	Ø 1.0	Ø 1.2	Ø 1.2
X % 40°C - ArCO ₂	150A - 60%	200A - 60%	290A - 60%	380A-100%
GRIP	GRIP	GRIP	GRIP	GRIP
L	3m	3m	4m	4m
Ref.	043251	040540	040557	040564

For fume Extraction Torches - Pour torches aspirantes

BINZEL
073715



- 230V / 1 ~, 1100 W
- 230 m³/h max
- 190 mbar max
- 25 kg, 590 x 425 x 825 mm
- 76 db
- Filter auto cleaning system - Système de nettoyage automatique du filtre - Automatische Filterabreinigung

Filtre Classe M, EN 60335-2-69

included: 5 m, Ø50

External evacuation Ø50 (hose not included)
Évacuation extérieure Ø50 (tuyau non inclus)

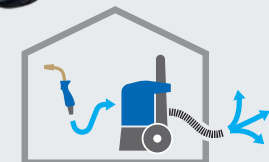

BINZEL

PROFESSIONAL BOX SET FOR WINDSCREEN REMOVAL - Coffret de découpe pare-brise
- Frontscheiben-Trennsystem für Akkuschrauberbetrieb

MADE IN
HIGH
QUALITY
GERMANY

057654

included
Axe enrouleur
068100

included
65 m
resistance 170 kg
Ø 0.79 mm
058125

optional
65 m
resistance 190 kg
Ø 0.92 mm
069275



OSCILLATING PNEUMATIC SAW FOR WINDSCREEN REMOVAL - Couteau pneumatique de découpe pare-brise
- Druckluft-Trennmesser für Windschutzscheiben

057623



Included
57 mm
057845

90 mm
057852

8 mm
057876

35 mm
057838

U
36 mm
057869

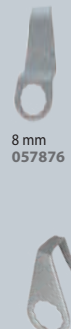

REMOVAL TOOL FOR WINDSCREEN WIPER ARMS - Extracteur d'essuie-glace - Wischerarm-Abzieher

UNIVERSEL
057630



30 mm
max

EXPERT

Accès difficile
- Difficult access
057647



40 mm
max



WINDSHIELD CUTTING KIT - Système de découpe pare-brise à cliquet
- Set zum Lösen von Windschutzscheiben

054738

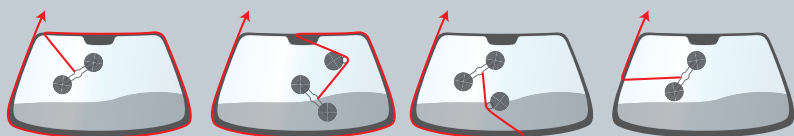

DASHBOARD PROTECTOR - Protections tableau de bord
- Armaturenbrett Schutz

053120

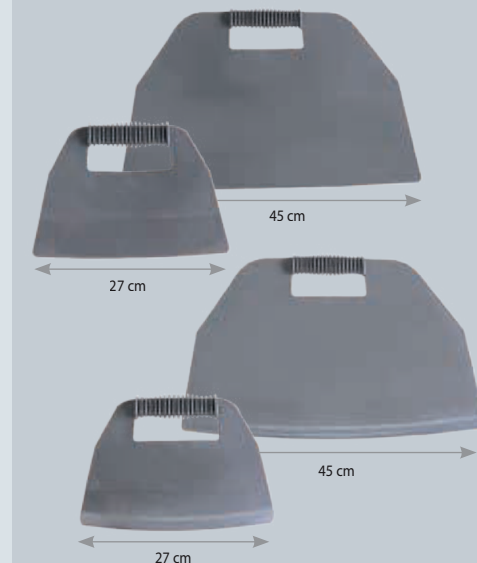

WINDSHIELD CUTTING TOOL - Outil découpe pare-brise
- Windschutzscheiben Demontage-Set

051935



WINDSCREEN JOINT-CUTTING KIT - Kit découpe joint de pare-brise - Scheibentrenn-Werkzeug-Set

051898



Corde à piano torsadé (22 m)
- Windscreen seal cutting wire
(twisted)
- Piano-Schneiddraht, gedreht,
22 m Rolle

051911

Corde à piano carré (50m)
- Windscreen seal cutting wire
(square)
- Vierkant-Draht,
50 m Rolle

051881

SUCTION LIFTING PADS - Ventouses - Saugnapfwerkzeug für Spiegelgläser

056695



Ø 70 mm



051966



x2

x6
057609

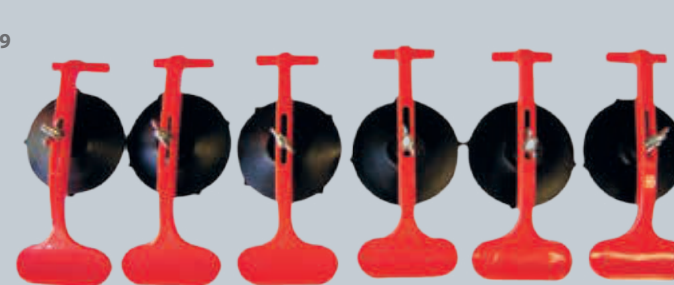

COMPRESSED AIR POLISHER - Renov'Polycarbonate - Druckluftpolierer

Complete pack

1 orbital sander
+ 1 polisher
- 1 ponceuse orbitale
+ 1 lustreuse

052086



2 SPEED

+

+

+

+

+

+

+

+

+

+

+

+

+

+

+

+

+

+

+

+

+

052055

052062

052079

sander Ø75
057494

polisher Ø75
058224

Ø 76

P 500 (x 10)
P 800 (x 10)
P 1500 (x 10)
P 3000 (x 10)



P 500 x 50 052017
P 800 x 50 052024
P 1500 x 50 052031
P 3000 x 50 052048



HOT STAPLER FOR BUMPER REPAIR - Agrafeuse pour réparation pare-chocs - Stoßstangen Reparatur Kit

052925



INCLUDED:
x20 x20 x20 x20 x20

MADE IN TAIWAN

PORTABLE
Battery operated - Sur batterie
058118

included
Li-ion battery 3.7V
048669
included adapters:
EUR, UK, USA & AUS

Charger included
048652

MADE IN TAIWAN



INCLUDED:
Ø 0.6, x100 Ø 0.8, x100

Adjustable
Ø 0.6, x100

Staples - Agrafes	V	U	N	W	M
	Inside corner - Angle interne étroit Ø 0.7 mm	Crack alignment - Alignement de fissure Ø 0.7 mm	Large crack - Fissure importante Ø 0.7 mm	Internal angle - Angle interne Ø 0.7 mm	External angle - Angle externe Ø 0.7 mm
	x 100 047990	x 100 047983	x 100 047976	x 100 047969	x 100 047952
052413	= x 50	+ x 50	+ x 50	+ x 50	+ x 50

PIERCING KIT FOR BUMPER SENSORS - Coffret de perçage pare-chocs pour détecteurs - Lochwerkzeug für Stoßfänger



PRO+
059139

Ø 17-18-18,2
19-20-22,5-24
26-26,7-32 mm



FREEZER

Freezer spray
- Spray refroidisseur

-50 °C

400 ml

(x 12)
048898



TOOL FOR REMOVING BUMPER - Outil de déclipsage pare-chocs



076518



x15
076525

HAND SEAMER FOR PLASTIC REPAIR
Pince de serrage pour réparation des plastiques

082014

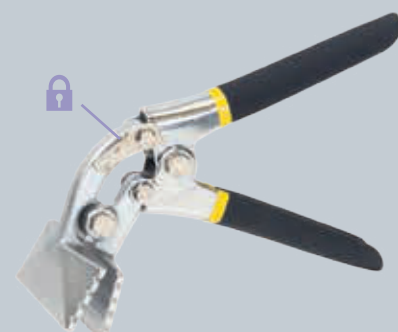

PLASTIC WELDING STATION - Station de soudage des plastiques - Kunststoff-Schweißset



320 W - 230 V, 1-50 Hz
Temperature: 160 < 480°C
▲ 3.4 kg
Length of hose: 1 m
Air flow: 24 l/min

Station seule
- Station only
064072



Ø 5 mm
066694

Ø 8 mm
066700



plastic rods - baguettes plastique 440 mm	PP / EPDM	▲ 4 mm	x 10	066304
		■ 6 mm	x 10	067622
		■ 8 mm	x 10	066298
	ABS	▲ 4 mm	x 10	071322
		■ 8 mm	x 10	071339

Station	PP/EPDM			Pressure wheels	Mini milling machine	Scraper
	4mm (x10)	6mm (x10)	8mm (x10)			
064072	✓					
070974			✓			



WELDING KIT FOR PLASTICS - Kit de soudage des plastiques - Kunststoff-Schweißset



1 600 W - 230V - 50/60 Hz
max. 230 l/min
▲ 1.3 kg / -L- Ø100 x 300mm,
poignée Ø 56mm.

057678

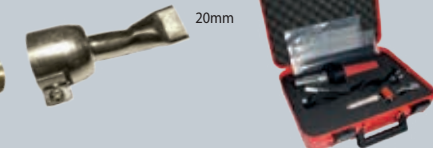

WORKSTATION PREMIUM 5 DRAWERS - Servante premium 5 tiroirs

± 64 kg
Capacity 320 kg



Complete carbody workstation
080119



included



HAND CHISEL FOR CAR BODY

- Burins
- Meißel für Karosserie



SET OF 4 NYLON CHISELS - Jeu de 4 burins en nylon - 4 Kunststoffmeißel

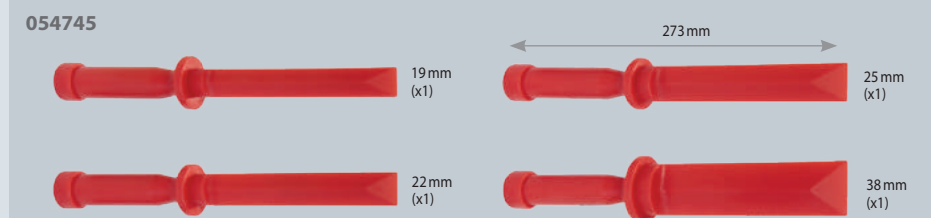

SET OF 3 CHISELS - Lot de 3 burins de séparation éléments collés - 3 Meißel



SET OF 30 TOOLS FOR SCRAPING/SANDING AND PAINT REMOVAL - Outils de dégarnissage et raclage - Polster & Schaber Kit



SET OF 3 SCRAPING KNIVES - Couteaux racloirs

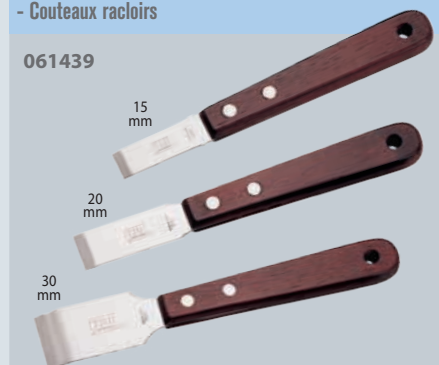

HAND TOOLS - Ausbeulwerkzeug

• FULL PACK =
061637



+ • MEDIUM PACK
051133



PLANISHING HAMMER BLACKTEC®

077270

Rubberised gripping
- Manche en caoutchouc



ALU HAMMERS - Marteaux alu

020986



PLANISHING KIT FOR CAR BODY (SET OF 3 HAMMERS + 4 DOLLYS) - Kit marteaux et tas - Karosseriehammer & Handfaust Kit



SET OF 3 ALU HAMMERS + 4 ALU DOLLIES - Kit marteaux alu et tas alu - Karosseriehammer & Handfaust Kit



FORMING TOOLS - Outils de forme - Formgebungswerzeuge



BODYWORK BUMPING Mallet - Maillet souple caoutchouc - Karosserie-Schlaghammer

083479



CONTOUR GAUGES - Jauges de profil - Konturenlehre



LIP PLIER - Pince à lèvres - Falzzange gebogen

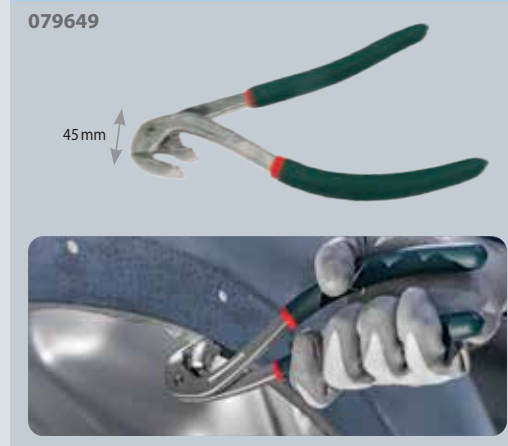

SET OF PLIER + 10 STAPLES - Coffret pinces à agrafes



POSITIONING CLAMP - Pincettes de maintien bord à bord - I-Stoß-Lehre

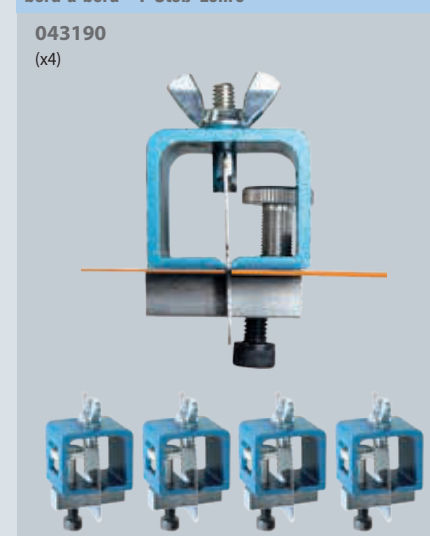

TEMPORARY-FASTENERS MANUAL MOUNTING - Serre-tôles

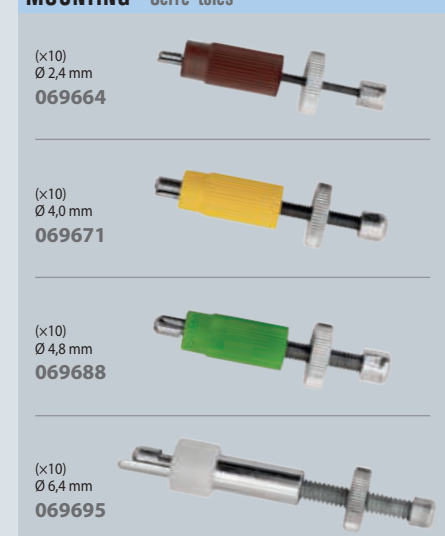

DOOR HINGE STRAIGHTENER - Redresseur de charnière de porte - Türgelekausrichter

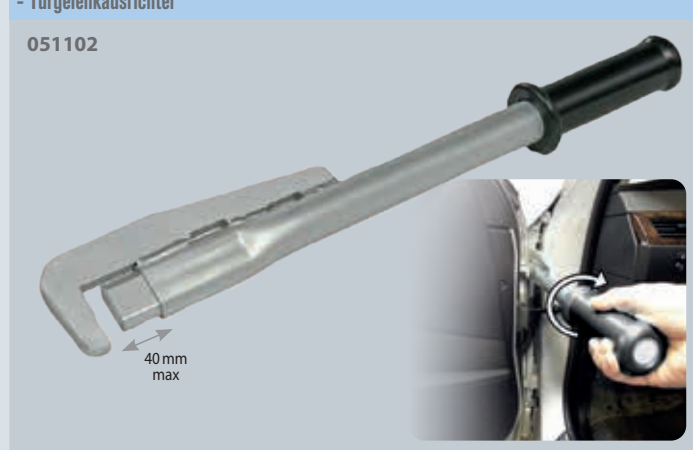

DOOR ALIGNING TOOL - Outil d'alignement de portière - Türausrichtungswerkzeug



GAPPING GAUGES - Jauges de positionnement - Spaltmaßlehre

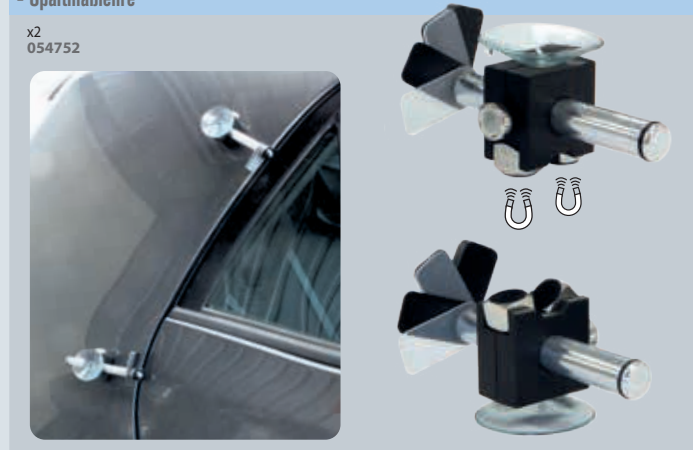

FENDER ROLLER TOOL SET - Outil de remise en forme passage de roue - Kotflügelrollen-Werkzeugsatz

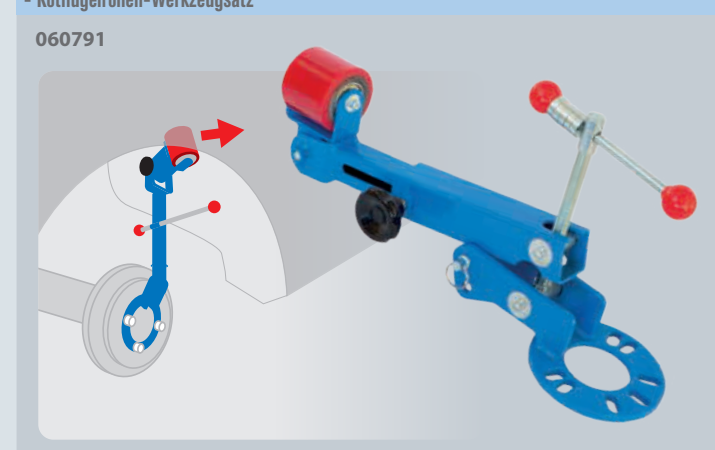

MICRO-GRIP CLAMPS - Pincettes micro-grip



MICRO-WELDING CLAMPS - Micro-brides de soudage



FLAT NOSE LOCK-GRIP PLIERS - Pincettes étai à bec plat

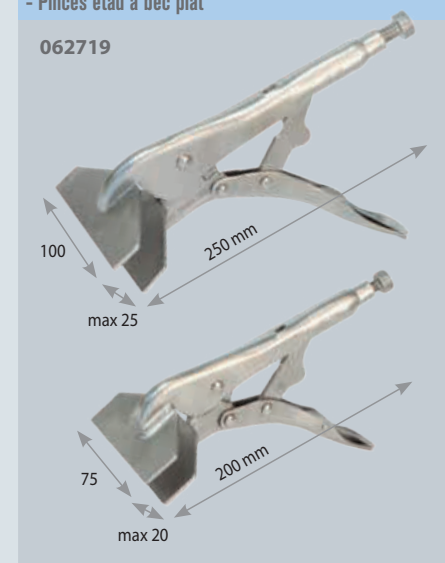

MULTI-CLIP PLIER - Pince multi-clip



BURR REMOVER - Outil d'ébavurage - Gratentferner

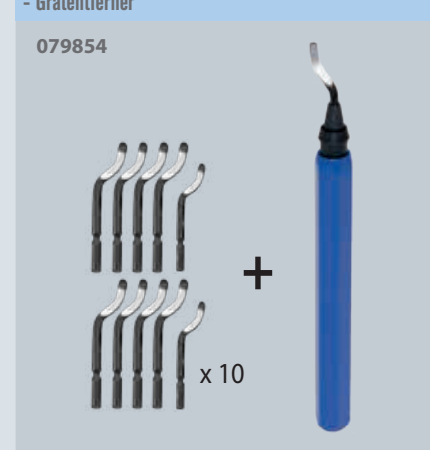

BODY LINE TOOL - Traceur de ligne carrosserie - Markierhilfe für Kanten



AXIAL-GRIP PLIERS - Pincettes axiales

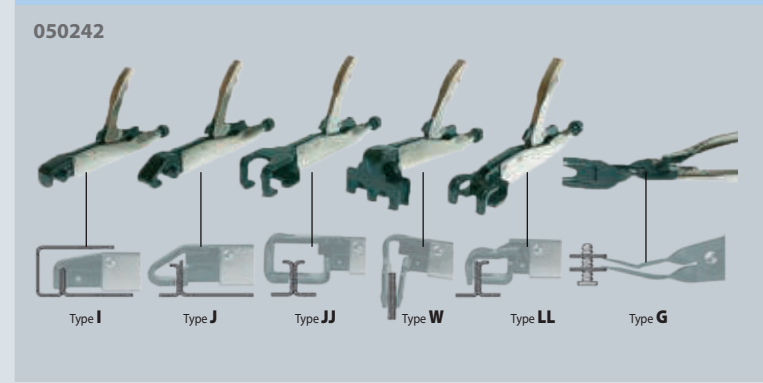

LOCK-GRIP PLIERS - Pincettes étai mono serrage

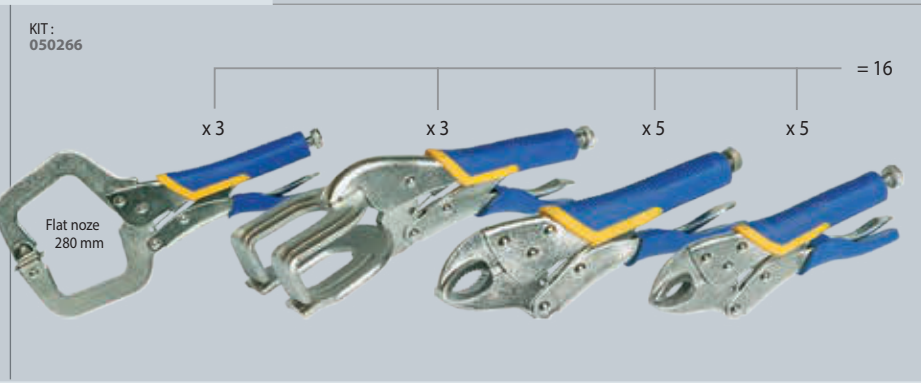
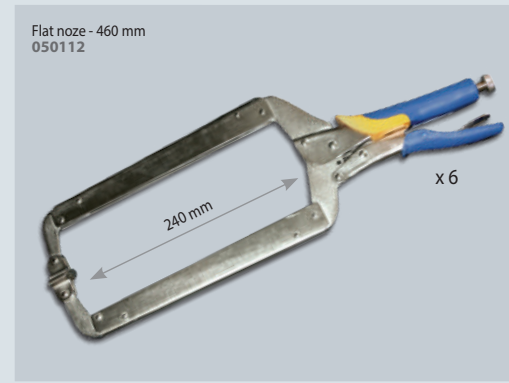
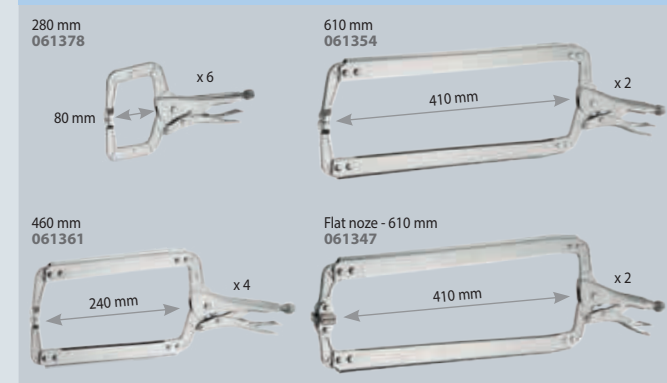

MINI DISC SANDER - Mini-meuleuse - Druckluftschleifer

051829

Speed adjustment

Ø 75 mm

Speed rpm	Power W	dB	Air consumption l/min	Air pressure bar	cm	kg
18000	200	83	171	6.2	12	0.7

Included (x1) 052468

058248

MINI-FLEXIDISC LAMELLES ZIRCON
Ø 50 mm

- K 40 (x10) 058255
- K 60 (x10) 058262
- K 80 (x10) 058279

Speed rpm	Power W	dB	Air consumption l/min	Air pressure bar	cm	kg
15000	84	91	6.2	10	0.6	

AIR BELT SANDER - Ponceuse à bande à tête orientable - Druckluft Bandschleifer

060906

360°

520 mm

20 mm

- Grain 60 (x 5) 060913
- Grain 80 (x 5) 060920
- Grain 100 (x 5) 060937
- Grain 36 céramique (x 5) 062535

Speed rpm	Air consumption l/min	Air pressure bar	cm	kg
16 000	171	6.3	34	1.2

AIR BELT SANDER - Ponceuse à bande à tête orientable - Druckluft Bandschleifer

052819

360°

330 mm

10 mm

- Grain 80 (x 10) 052833
- Grain 36 céramique (x 20) 062528

Speed rpm	Air consumption l/min	Air pressure bar	cm	kg
16000	171	6.3	26	0.9

MINI ANGLE MILLING MACHINE - Mini-fraiseuse à renvoi d'angle - Mini-Winkelschleifer

051836

90°

Speed rpm	Power W	dB	Air consumption l/min	Air pressure bar	cm	kg
18000	500	81	85	6.2	18	0.7

AUTOMATIC MANDREL DRILL - Perceuse mandrin automatique - Druckluftbohrmaschine m. Schnellspannfutter

051799

Ø 13

Speed rpm	Power W	dB	Air consumption l/min	Air pressure bar	cm	kg
800	300	92	170	6.2	18	0.9

LONG HANDLED ANGLE GRINDER - Meuleuse d'angle - Druckluft-Winkelschleifer

057753

Ø 100 mm

- ± 1.6 mm, x5 057883
- ± 0.8 mm, x5 058217

Speed rpm	Power W	dB	Air consumption l/min	Air pressure bar	cm	kg
14000	84	113	6.2	37	1.7	

MINI ANGLE GRINDER - Mini-meuleuse à renvoi d'angle - Mini-Druckluftwinkelschleifer geräuschgedämpft

051867

90°

Ø 50 mm

(x1) 052772

Speed rpm	Power W	dB	Air consumption l/min	Air pressure bar	cm	kg
15000	200	86	85	6.2	18	0.75

SAW FOR STRAIGHT CUT AND FILE - Scie coupe tôle droite et lime - Druckluftsäge und Feile

051805

(x5) 052789

included 058750

Speed rpm	Power W	dB	Air consumption l/min	Air pressure bar	cm	kg
5000	—	85	255	6.2	10	0.8

PNEUMATIC SURFACE REMOVER KIT - Coffret décapeuse pneumatique - Druckluftentroster-Box inkl. Zubehör

051775

- Roue gomme 115 x 14 mm 051874
- Roue à découper 115 x 14 mm 051843
- Adaptateur pour brosse 051768
- Brosse souple Brins droits 0.5 mm 103 x 23 mm 052598
- Brosse dure Brins incurvés 0.7 mm 103 x 23 mm 051812
- Brosse souple Brins incurvés 0.5 mm 103 x 23 mm 051850

Speed rpm	Power W	dB	Air consumption l/min	Air pressure bar	cm	kg
4000	500	86	102	6.2	280	1.2

MINI MILLING MACHINE - Mini Fraiseuse - Mini-Schleifer

063228

Option Tungsten drill Ø 6 mm 054172

LASER CORD METAL SHEET CUTTER (NIBBLER) - Dépointeuse pour cordon laser ACIER - Trennwerkzeug für Lasernähte

054165

Ø 6 mm

STEEL Included 054172

6 mm 20 mm 052437

8 mm 20 mm 067264

SPOT REMOVER - Dépointeuse - Druckluft-Schweißpunktbohrer

SPOT DRILL 050464

360°

Ø 8

Included: Tungsten Carbide Ø 8 for BORON/UHSS (x1)

HIGH QUALITY

Spot remover drill - Forets de dépointage - Schweißpunktfräse Tungsten Carbide for BORON/UHSS

Speed rpm	Power W	dB	Air consumption l/min	Air pressure bar	cm	kg
800	400	85	140	6.5	35	2.3

PNEUMATIC FLANGE / PUNCHING TOOL - Pince à soyer et à trouser, pneumatique - Pneumatische Loch- und Absatzzange

079892

Ø 8 mm

0.8 > 1,2 mm

052543

Ø 5 mm

0.8 > 1,2 mm

2 in 1

0.8 > 1,2 mm

BODY ZIPPER - Sertisseuse pneumatique - Pneumatic Crimper - Druckluftkantenformer

056930

MADE IN HIGH QUALITY POLAND

- MINI
- initial W
- final M x < 2.4mm
- final D x > 2.4mm

Air pressure bar	cm	kg
5	28	2.1

PACK SPOT DRILL + 140 mm 061460

140 mm

3-edge Ø 8 mm 053069

140 mm 061453



HAND LAMPS - Lampes baladeuses - Handleuchte

PORTABLE HAND LAMP 400 L 400 lumens

COB LED
Li-ion
Charging time: 8h
operating time
High position: 2.5 h
Low position: 5 h
Top light (1 W): 6 h

↳ 7 x 4 x 23 cm / 0.3 kg
⊗ 14 x 7 x 24 cm / 0.5 kg

059153



PRO PORTABLE LAMP 600 L 250-600 lumens

COB LED, 80 CRI
3.7 V - 2200 mAh Li-ion
micro USB charging (3.5 h)
operating time
High position: 1.5 h,
Mid position: 4.5 h,
Top light (100 lumens): 10 h

IP 54
↳ 3 x 6 x 19 cm / 0.3 kg
⊗ 9 x 13 x 24 cm / 0.6 kg

060883



INSPECTION LAMPS

- Lampes d'inspection - Inspektionlampen

INSPECTION HEADTORCH 280 L 100-280 lumens

3 W COB LED, 80 CRI+, 6500 K
3.7 V - 1500 mAh Li-po
micro USB charging
mains charger not incl.
operating time
High position: 2 h
Low position: 6 h
IP 65

↳ 8 x 5 x 4 cm / 0.1 kg
⊗ 5 x 11 x 18 cm / 0.2 kg

060845



360° PORTABLE WORKSPACE LAMP 1000 L 60-1000 lumens

>80 CRI SMD LED
6500 K
3.7 V - 5200 mAh Li-ion
USB charging (4.5h)
USB power supply
operating time 2 > 27 h

IP 54
↳ 26 x 7 x 7 cm / 0.5 kg
⊗ 8 x 8 x 35 cm / 0.7 kg

059764



MINI INSPECTION LAMP 200 L 120-200 lumens

COB LED, 80 CRI, 6500 K
3.7 V - 700 mAh Li-ion
micro USB charging (2.5 h)
mains charger not included
operating time
High position: 1.5 h
Low position: 4 h
Top light: 3.5 h
IP 20

↳ 18 x 3 x 3 cm / 0.1 kg
⊗ 18 x 5 x 3 cm / 0.2 kg

060852



MINI INSPECTION LAMP 350 L 0-350 lumens

COB LED
3.7 V - 1100 mAh Li-ion
USB charging (3 h)

operating time
3 > 6.5 h

IP 20

075894

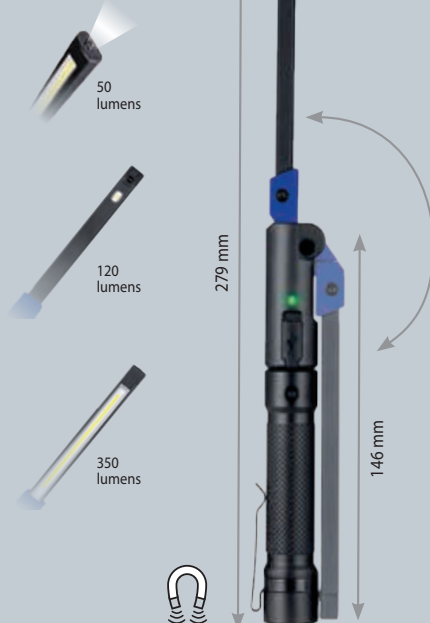

PRO INSPECTION LAMP 800 L 120-800 lumens

COB LED
3.7 V - 2600 mAh Li-ion
USB charging (4 h)

operating time
2.5 > 9 h

IP 54

075900

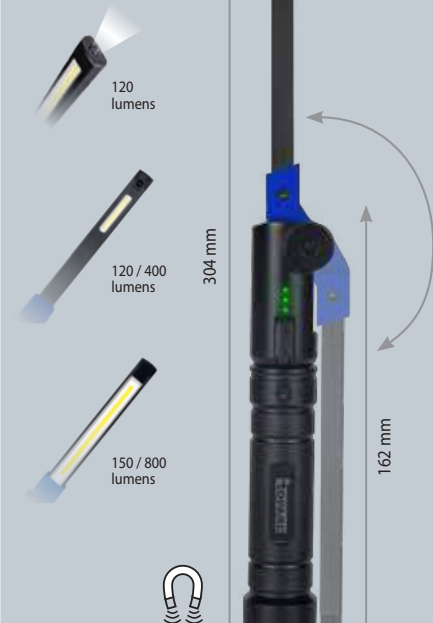

LED WORKLIGHTS WITH TRIPOD - Projecteurs led sur trépied - LED-Arbeitsleuchte mit Standfuß

TRIPOD LAMP 1800 L 1800 lumens

3x 55 COB LED
total 165 LED

1.8 m power cord

059146

⊗ 95 x 15 x 14 cm / 3.2 kg

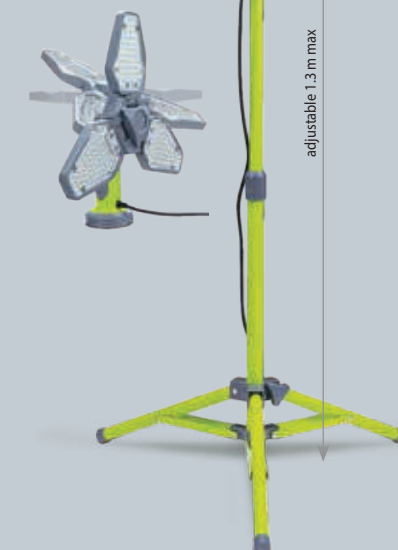

TRIPOD LAMP 3000 L 3000 lumens

35 W COB LED

2 m power cord

IP 44

059979

↳ 100 x 20 x 9 cm / 3.6 kg
⊗ 103 x 22 x 10 cm / 4.1 kg



TRIPOD LAMP 4000 L 4000 lumens

3x 20 COB LED,
total 60 LED

3 m power cord

059986

↳ 21 x 15 x 114 cm / 5.7 kg
⊗ 22 x 116 x 117 cm / 6.4 kg



UNDER BONNET LAMPS - Lampes sous capot - Leuchte für Motorhaube

UNDER BONNET HAND LAMP 600 L 500-1000 lumens

120 COB LED

3.7 V - 4000 mAh Li-ion
charging time: 10/12 h

operating time
High position: 4 h
Low position: 8 h

↳ 22 x 11 x 68 cm / 1.8 kg
⊗ 24 x 12 x 70 cm / 2.3 kg

059962

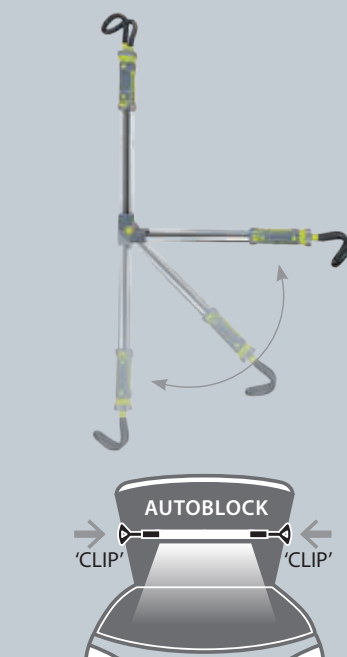

UNDER BONNET LAMP AND TRIPOD 800 L 250-800 lumens

120 COB LED

3.7 V - 4000 mAh Li-ion
charging time: 10/12 h

operating time
High position: 3 h
Low position: 6 h

↳ 60 x 10 x 7 cm / 1.2 kg
⊗ 61 x 15 x 12 cm / 2 kg

058002



DETAILING & COLOUR MATCH - Contrôle des couleurs - Fabnpassung & Aufbereitung

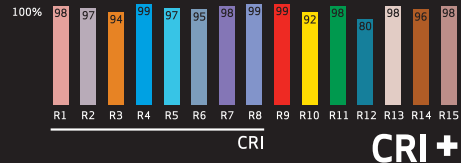

4500 K

400 lumens

SUNCOLOR 1
COB LED, CRI > 95, 1100 lux
3.7 V - 2600 mAh Li-ion
USB charging
operating time : 3 h
↓ 6 x 3 x 19 cm / 0.6 kg
⊗ 22 x 14 x 10 cm / 0.7 kg
IP 65

058477



3 COLORS

2700 - 4500 - 6500 K

350-420-450 lumens

SUNCOLOR 3
COB LED, 96 CRI+
3.7 V - 2600 mAh Li-ion
micro USB charging (4 h)
operating time : 2.5/4 h
IP 65
↓ 4 x 6 x 9 cm / 0.3 kg
⊗ 9 x 13 x 24 cm / 0.6 kg

060838



5 COLORS

2700 - 3500 - 4500 - 5500 - 6500 K

500-1000-2000 lumens

SUNCOLOR 5
COB LED, 96 CRI+
11.1 V - 4400 mAh Li-ion
charger 110/240 V, 5 m cable, 15 V, 1.5 A
charging time : 3.5 h
operating time
High position : 2 h, Mid : 4 h, Low : 8 h
IP 65
↓ 7 x 23 x 20 cm / 1.2 kg
⊗ 9 x 25 x 24 cm / 1.9 kg

060876

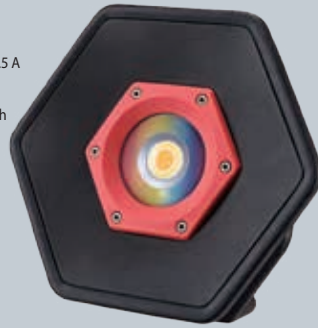

5 COLORS

2500-3500-4500-5500-6500 K

50-200-500 lumens

SUNMATCH 4
COB LED, 96 CRI+, 700-1400 lux
3.7 V - 2600 mAh Li-ion, USB charging
operating time :
High position : 2 h, Low position : 4 h
IP 65
↓ 4 x 6 x 19 cm / 0.3 kg
⊗ 8 x 9 x 21 cm / 0.5 kg

061651



UV CURING - SÉCHAGE UV

UV LED λ 395-400 nm

Irradiance 6-15 mW/cm²

NOVA-UV 5

3.7 V - 5400 mAh Li-ion
USB charger, 1 m cable, 5 V, 2 A
charging time : 3.5 h
operating time 1.5 h
IP 67
↓ 7 x 17 x 16 cm / 0.9 kg
⊗ 7 x 17 x 18 cm / 1 kg

061620



FILM COATING THICKNESS GAUGE

- Détecteur épaisseur de peinture

059856

Measurement range : 0 - 1.80mm
Resolution : 0.01 mm / 1 mm
Measurement error : +/- 0.03 mm
Power Supply : 2x 1.5V AAA batteries (included)
Overall dimensions : 62 x 30.5 x 105 mm



4 MAGNETIC PANEL EDGE PROTECTIONS

- 4 protections magnétiques de ponçage pour bord de panneau

082793

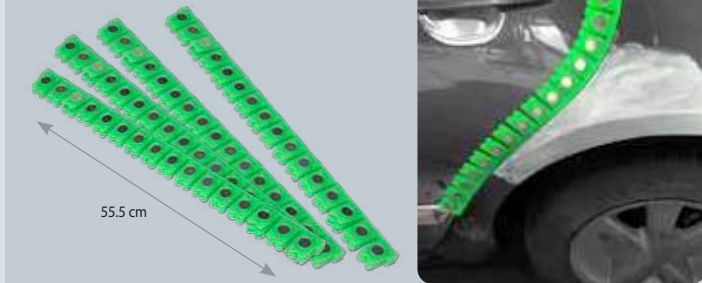

ELECTRIC SANDER & POLISHER

- Ponçeuse /polisseuse électrique - Elektro-Polier-Schleifer

057999

Orbital 5.0 mm
↓ 27 x 15 x 10 cm / 1.5 kg
⊗ 37 x 18 x 12 cm / 1.9 kg

Speed : 4000, 7000, 9000 10000 rpm
AC-in 220V - 230V / 50 - 60Hz

Light weight
& Compact

((No vibration))

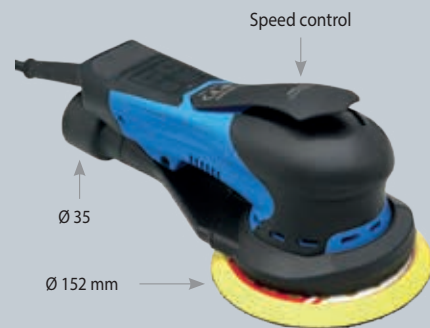

058293

Power supply : 230V / 50Hz
Power : 1400W (max 2000W)
Max. vacuum : 170 mbar
Air flow : 2700 l/min
Drum capacity : 30 L
Drum material : stainless steel

↓ 33 x 33 x 63 cm / 4.9 kg
⊗ 38 x 38 x 67 cm / 7.8 kg

Manual or automatic



4m
Input Ø 32 mm
Mains cable length 4.5m

GYS DUST EXTRACTOR - Pneumatic dust vacuum cleaner for sander

INNOVATIVE SUCTION SYSTEM

Depression **1150 mm H2O**
Air flow **600 l/min**
Air consumption **340 l/min**



Adjustable sander pressure - Pression ponçeuse ajustable
5 bar max

↓ 49 x 48 x 88 cm / 21.5 kg
⊗ 81 x 40 x 49 cm / 24.1 kg



EN 60335-2-69 : 2012

- ✓ **ROBUST**
- ✓ **QUICK & SAFE**
- ✓ **LOW AIR CONSUMPTION** (5 bar)
- ✓ **NO ELECTRIC MOTOR**
- ✓ **ENERGY SAVING**

Sanding discs box*
- Rangement pour disques de ponçage*
* discs box not included - disques de ponçage non inclus

Grande maniabilité et stabilité
- High maneuverability and stability

EASY ACCESS

Maintenance free
- Aucune maintenance

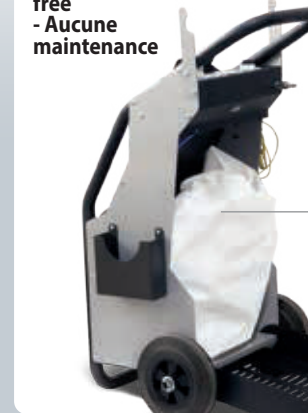

Consumables

Sac à poussières - Filter bag
Capacity 5 kg
Included x1
x 5
058880



Pneumatic Sander
- Ponçeuse pneumatique
MIRKA PROS 650CV
Ø 150 mm
071346

2 MODELS

GYS DUST EXTRACTOR

MANUAL

Manual start
- Démarrage manuel

071353



GYS DUST SELF EXTRACTOR

AUTOMATIC

Automatic start
- Démarrage automatique

077058



ERGONOMIC PRO SUPPORT FOR PAINTING ELEMENTS - Support Pro ergonomique pour peinture d'éléments
- Ergonomische Pro-Unterstützung für Malelemente

082656

NEW
05/2024

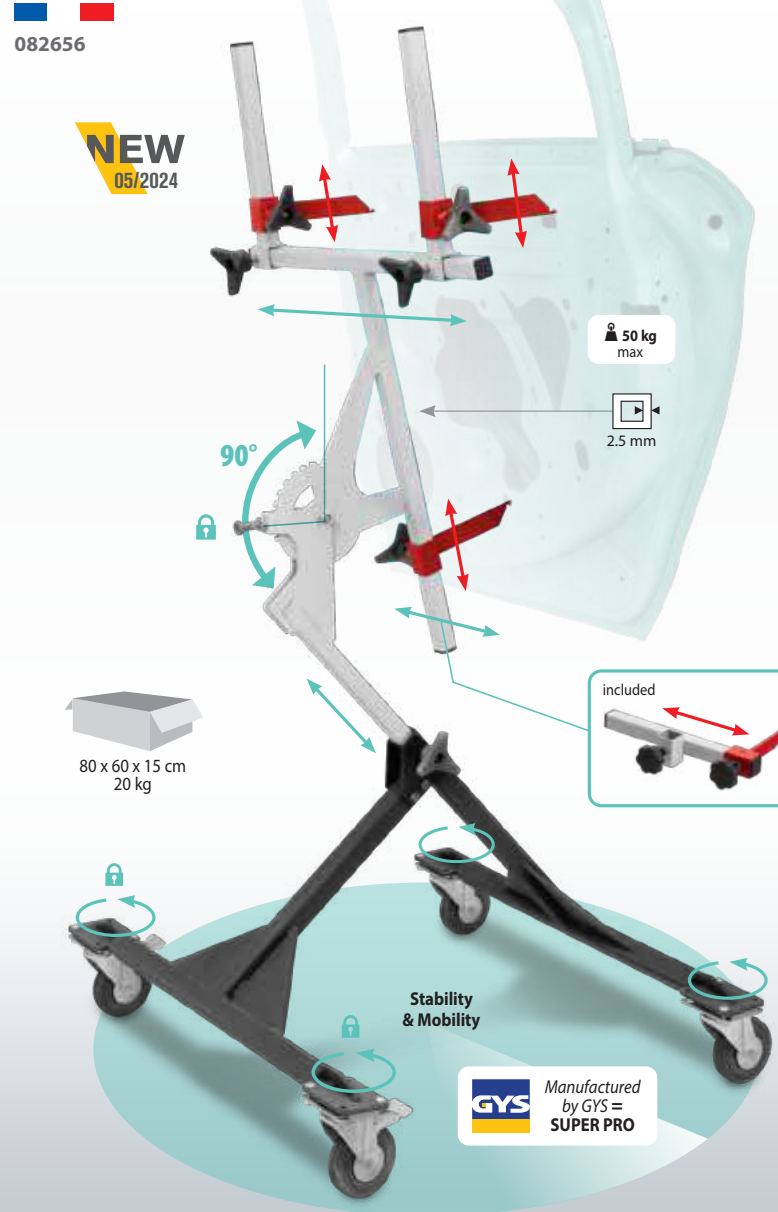

50 kg max

2.5 mm

90°

80 x 60 x 15 cm / 20 kg

included

Stability & Mobility

GYS Manufactured by GYS = SUPER PRO

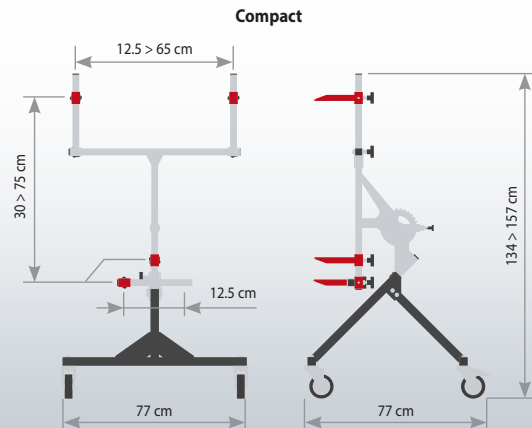
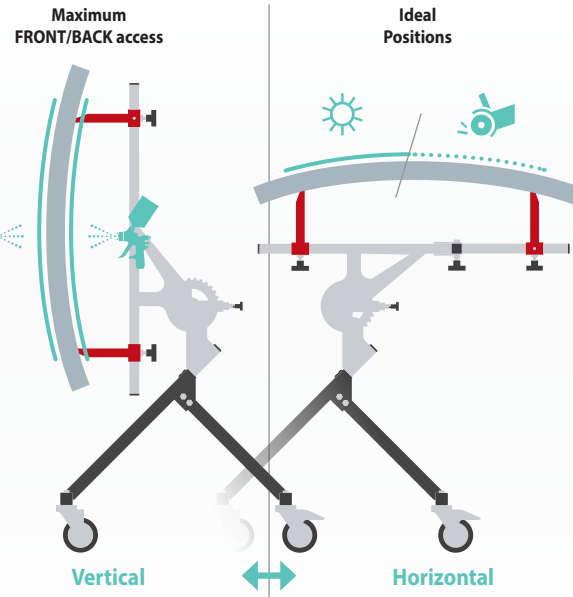

FRAMES SUPPORT - Tréteaux - Klappbücke

040601
↓ 105 x 33 x 9 cm / 6.3 kg
⊗ 107 x 35 x 10 cm / 6.7 kg

040250
↓ 100 x 105 cm - 7.1 kg
⊗ 104 x 10 x 32 cm / 7.5 kg

083875
14.4 kg
⊗ 108 x 9 x 47 cm / 16.5 kg

Adjustable catenary - Chainette réglable

Protecting foam - Mousse de protection

Non-slip base - Antidérapants

Ø 28 mm

Ø 32 mm

70 > 95 cm

101 cm

30 > 80 cm

NEW

040311
↓ 106 x 31 x 6 cm / 6.6 kg
⊗ 106 x 31 x 11 cm / 9.7 kg

Ø 32 mm

Suction pad for glazing
- 4 ventouses
Dépose vitrages
- Gummiteiler zur Fixierung von Glasscheiben

040304
↓ 105 x 109 cm / 7.2 kg
⊗ 107 x 32 x 10 cm / 7.8 kg

Ø 32 mm

Light and easy to handle
Idéal for horizontal works
- Léger et très maniable
Spécial travaux à l'horizontal
- Speziell geeignet für Arbeiten in horizontaler Position

ROTARY ELEMENT SUPPORT
- Support pare-chocs - Lackierstander für Stoßstange, einstellbar

052376

↓ 50 x 70 x 10 cm / 7.3 kg
⊗ 60 x 77 x 12 cm / 8.3 kg



Adapted to wing mirror covers - Adapté aux coques de rétroviseurs - Geeignet für Außenspiegel

TELESCOPIC FRAMES SUPPORT - Tréteaux télescopiques - Teleskopbücke

070677

29 kg

NEW
08/2024

30 > 100 cm

81 cm

85 > 120 cm

⊗ 81 x 74 x 14 cm / 30.7 kg

070677

16.5 kg

MADE IN HIGH QUALITY POLAND

15 > 125 cm

20 x 20 mm

3 mm

88 > 128 cm

87 cm

ROTARY ELEMENT SUPPORT - Support élément rotatif
- Lackierstander für Stoßstange, einstellbar

052611

200 x 101 cm - 19 kg
⊗ 112 x 35 x 13 cm / 23 kg
Made in China

1.5 mm

360°

2 mm

PRO
056725

200 x 105 x 81 cm - 21.5 kg
⊗ 120 x 26 x 18 cm / 22 kg

MADE IN HIGH QUALITY POLAND

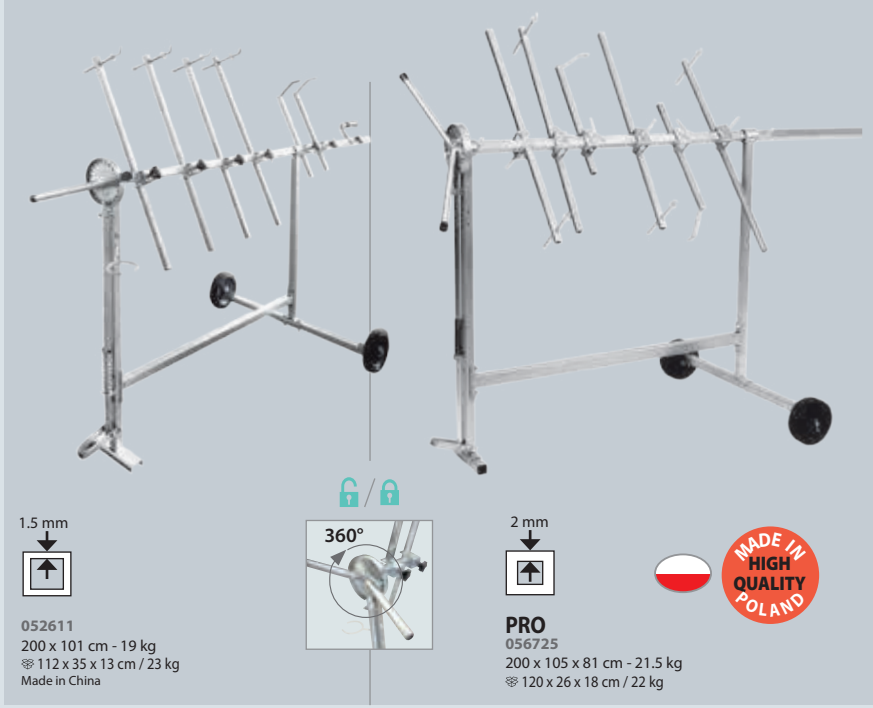

WHEELS PAINTING SUPPORT - Support de peinture pour 2 jantes - Lackträger für 2 Felgen

082168

⊗ 83 x 45 x 35 cm / 25 kg

15" → 22"

109 cm

95

67

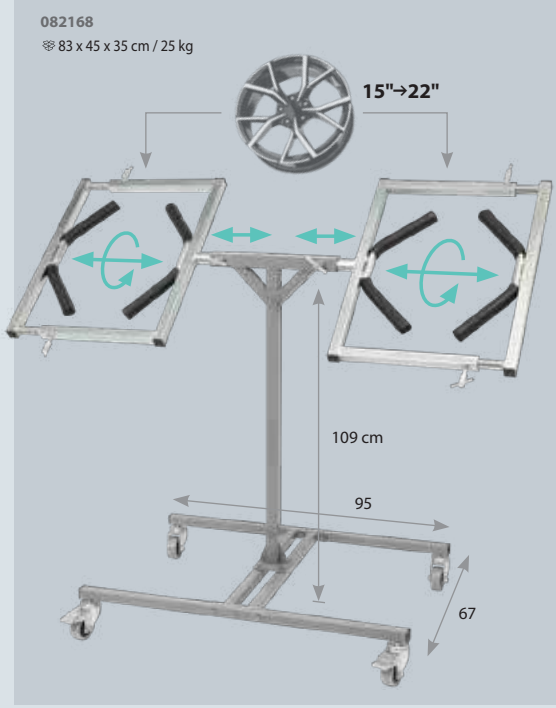

MASKING MACHINE
- Chariot de marouflage - Abdeckpapier-Ständer

083905

132 x 95 x 91 cm / 35 kg
⊗ 109 x 92 x 27.5 cm / 37 kg

NEW

x 4 (not included)

Paper roll - Rouleaux de papier - Papierständer

30, 60, 100, 100 cm

Ø 75 mm

Ø 250 mm



PREMIUM MASKING MACHINE
- Chariot de luxe marouflage - Abdeckpapier-Ständer

057333

150 x 133 x 62 cm / 31 kg
⊗ 152 x 30 x 18 cm / 31.5 kg

x 5 (not included)

Paper roll - Rouleaux de papier - Papierständer

30 > 120 cm

Ø 75 mm

Ø 250 mm



MASKING MACHINE
- Chariot de marouflage - Abdeckpapier-Ständer

056954

150 x 62 x 110 cm / 11 kg
⊗ 154 x 30 x 19 cm / 12 kg

MADE IN HIGH QUALITY POLAND

OPTION

Ø 40 mm x 6
058897

x 3 (not included)

Paper roll - Rouleaux de papier - Papierständer

30, 60, 90 cm

Ø 75 mm

Ø 250 mm

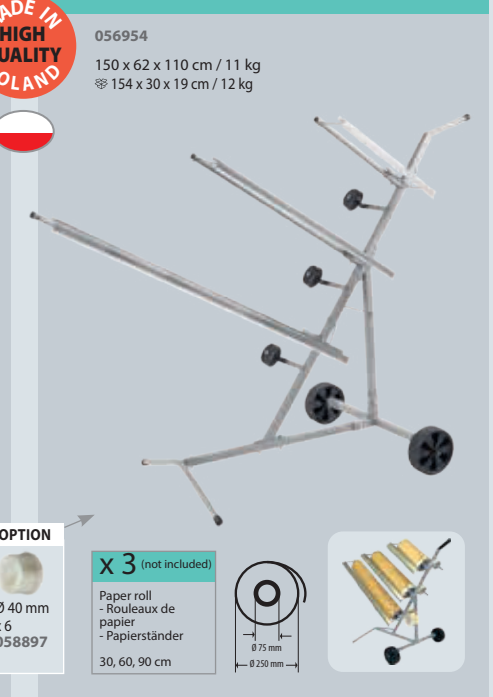

STORAGE TROLLEY - Chariot de stockage
- Lagerrollwagen

059825

106 x 104 x 215 cm - 32.5 kg
112 x 31.5 x 21.5 cm
+ 12 x 9.5 x 194.5 cm

STORAGE TROLLEY - Chariot de stockage
- Lagerrollwagen

059832

↓ 50 x 150 cm
11.3 kg
155 x 18 x 12 cm
13.8 kg

STORAGE TROLLEY - Chariot de stockage
- Lagerrollwagen

040243

71 x 90 x 197 cm / 41 kg

⊗ 2 :
90 x 6 x 147 cm
+ 97 x 74 x 24 cm

UNIVERSAL SUPPORT - Chariot pour éléments de carrosserie
- Universelle Ständer

083868

56 kg
102 x 72 x 27 cm / 59 kg

NEW

210 cm
+ 60 cm
85 cm
100 cm

FOLDING STEP STOOL - Marche pied (Aluminium)
- Arbeitspodest klappbar

080041

7.3 kg
100 x 39.5 x 19 cm / 8.1 kg

ALU

150 kg max

850 mm
490 mm
1180 mm
300 mm

MOBILE RACK FOR CAR BODY REPAIR - Rack mobile pour éléments de carrosserie

082472

128 x 30 x 15 cm / 20 kg
↓ 18.8 kg

NEW

150 kg max

635 mm
1200 mm
700 mm

FOLDING STEP STOOL - Marche pied (Aluminium)
- Arbeitspodest klappbar

057562

7.9 kg
102 x 39 x 19 cm / 8.5 kg

ALU

150 kg max

960 mm
475 mm
385 mm

FLAP LOCK - Tiges de blocage

056732

30 > 115 cm

FOLDING STEP STOOL - Marche pied (Aluminium)
- Arbeitspodest klappbar

058552

↓ 113 x 41 x 16 cm / 16 kg
117 x 42 x 17 cm / 17 kg

ALU

150 kg max

1090 > 1750 mm
520 > 900 mm
300 mm

ROUND STOOL WITH TOOL STORAGE - Tabouret - Werkstatt-Rollhocker

057555

38 x 38 x 44 cm - 5.2 kg
41 x 19 x 41 cm / 5.6 kg

max : 50 cm
min : 38 cm

6 cm

ROUND STOOL WITH STORAGE - Tabouret d'atelier 3 tiroirs

079878

47 x 35 x 43 cm
38.5 x 37 x 38.5 cm - 13 kg

MECHANICS CREEPER WITH TILTING HEADREST - Chariot de visite - Werkstatt-Rollliege

057548

102 x 43 x 11 cm / 5.3 kg
104 x 45 x 13 cm / 6 kg

2 IN 1 MECHANICS CREEPER - Chariot de visite 2 en 1 - Werkstatt-Rollliege

079861

102 x 40 x 14 cm
40 x 13 x 63 cm - 7.6 kg

WORKSTATION PREMIUM 5 DRAWERS - Servante premium 5 tiroirs

076143

64 kg
Capacity 320 kg

4 Keys - 4 Clés

105 cm
56 cm
87 cm

32 x 45 x 6 cm
65 x 48 x 12 cm
75 x 47 x 9 cm
65 x 45 x 12 cm
32 x 45 x 12 cm

MOBILE WORKSTATION - Table de travail mobile

079465

120 x 82 x 18 cm / 40.3 kg

100 kg max

1170 mm
390 mm
1030 mm
750 mm
Ø 290 mm

WORKSTATION 3 SHELVES - Servante 3 plateaux

068056

77 x 53 x 21 cm / 18.2 kg

65 kg max

65 kg max

65 kg max

835 mm
300 mm
800 mm

1T MOBILE LIFTING TABLE WITH HYDROPNEUMATIC PUMP - Table élévatrice mobile 1 tonne avec pompe hydropneumatique
- Mobilier 1-Tonnen-Hubtisch mit hydropneumatischer Pumpe

083912
Weight: 385 kg

NEW

Reserved holes pattern - Quadrillage de trous taraudés
100 x 100 mm M10

max: 148 cm
min: 130 cm

1 t max

Hydropneumatic pump - Pompe hydropneumatique

110 s ↑
30 s ↓

6-8 bar

min: 570 cm

max: 180 cm

105 cm

130 cm

Ø 20 cm

1.2T LIFTING TABLE FOR ELECTRIC VEHICLE BATTERIES - Table de levage 1.2T pour batteries de véhicule électrique
- 1,2T Hubtisch für Elektrofahrzeugbatterien

083929
Weight: 760 kg

NEW

Reserved holes pattern - Quadrillage de trous taraudés
100 x 100 mm M10

1.2 t max

230 V ~1 phase
50 Hz

FAST: 45 s ↑
PRECISE: 170 s ↑
40 s ↓

80 cm

max: 207 cm
min: 174 cm

4 cm

2 cm

min: 80 cm

max: 181 cm

90 cm

Ø 20 cm

235 cm

EQUIPMENT FOR OPERATIONS ON ELECTRIC AND HYBRID VEHICLES - Équipements pour opérations sur véhicules électriques & hybrides -
Ausrüstung für den Betrieb von Elektro- und Hybridfahrzeugen

FACE SHIELD WITH HEADBAND
- ÉCRAN FACIAL AVEC SERRE-TÊTE
068018

INSULATING GLOVES (T10)
- GANTS ISOLANTS (T10)
068025

25 pieces insulated tools 1000V - Coffret de 25 outils isolés 1000V
- Box mit 25 isolierten Werkzeugen 1000V
066489

7/8/10/12/14/15/17/19/22 mm sockets - Douilles 7/8/10/12/14/15/17/19/22 mm	x 9
175 mm universal pliers in chrome vanadium - Pince universelle de 175 mm en chrome vanadium	x 1
Cutting pliers 150 mm in chrome vanadium - Pince coupante 150 mm en chrome vanadium	x 1
3/8" ratchet - Cluqlet en 3/8"	x 1
Extension 100 mm - Rallonge 100 mm	x 1
T-handle - Poignée en T	x 1
Open ended wrenches 7/8/10/12/14/17 mm - Clés plates à fourches 7/8/10/12/14/17 mm	x 6
Cable knife - Couteau pour câble	x 1
Philips PhH1x100/PhH2x100 mm screwdriver - Tournevis Phillips PhH1x100/PhH2x100 mm	x 2
Flat screwdriver 5.5x125 / 4x100 mm - Tournevis plats 5.5x125/4x100 mm	x 2

Kit for marking the area of intervention
- Kit pour le balisage de la zone d'intervention
- Kennzeichnungsset für Hochvolt-Bereiche
064409

Red and white warning pole - Balise de signalisation rouge et blanche	x 4
Red and white bounding line - Chaîne de délimitation rouge et blanche	x 1
Sign board "Danger, working area EHV" - Pancarte de signalisation "Danger, zone de travail VEH"	x 2

TROUSERS - Pantalon - Hose

98% cotton, 2% antistatic

EN ISO 11611 Class 2-A1 & A2
046368

EN ISO 11612 A1+A2-B1-C1-E3-F1
046375

IEC 61482-2 Class 1-4kA
EN 14404 +A1 Type 2

S (40/42) 046368
M (44/46) 046375
L (48/50) 046382
XL (52/54) 046399
XXL (56/58) 046412

JACKET - Veste - Jacke

98% cotton, 2% antistatic

EN ISO 11612 A1+A2-B1-C1-E3-F1
046313

EN ISO 11611 Class 2-A1 & A2
EN 14404 +A1 Type 2
EN 1149-5

S (40/42) 046313
M (44/46) 046320
L (48/50) 046337
XL (52/54) 046344
XXL (56/58) 046351



French manufacturer
since 1964



Tools

Tel: +32 (0)10 39 51 50
info@vbtools.be • www.vbtools.be

Voor technisch advies,
Pour toutes informations techniques,

Jonathan Govaers

Vlaams Brabant, Limburg, Oost-, West-Vlaanderen, Provincie Antwerpen.
jonathan.govaers@vbtools.be
0490/11.00.87

Sebastien Akel

Hainaut, Brabant Wallon, Province de Namur, Liège, Luxembourg et du Grand-Duché.
sebastien.akel@vbtools.be
0490/11.91.95

Distributed by

