



French manufacturer
since 1964

INVEST IN THE
FUTURE

www.gys.fr

www.gys.fr



Tel: +32 (0)10 39 51 50 • Fax: +32 (0)10 46 02 78
info@vbtools.be • www.vbtools.be

Voor technisch advies,
Pour toutes informations techniques,

Roy Backeljauw

Oost-, West-Vlaanderen, Provincie Antwerpen
roy.Backeljauw@vbtools.be
0490/11.91.96

Jonathan Govaers

Hainaut, Brabant Wallon, Vlaams Brabant, Limburg
jonathan.govaers@vbtools.be
0490/11.00.87

Sebastien Akel

Province de Namur, Liège, Luxembourg et du Grand-Duché.
sebastien.akel@vbtools.be
0490/11.91.95

Gedistribueerd door:
Distribué par :



- SPOTTER
- DENT PULLER
- MIG
- PLASMA
- INDUCTION
- LIFT
- RIVETING
- ACCESSORIES

Uitsluitend bestemd voor de vakman. De vermelde prijzen zijn zonder BTW. Zij zijn niet bindend en kunnen op elk moment zonder voorafgaandelijk bericht gewijzigd worden. De foto's zijn illustratief en worden zonder verbintenis gegeven. Aanbiedingen zijn geldig tot 30 juni 2021.
Ce catalogue est exclusivement réservé aux professionnels. Les prix mentionnés sont hors TVA. Ils ne sont pas impératifs et peuvent être changés à chaque instant sans avis préalable. Les photos sont illustratives et non contractuelles.
Prix valables jusqu'au 30 juin 2021



French manufacturer
since 1964

Car Body Welding Systems

Catalogue Carrosserie
Catalogo Carrozzeria
Karosserie-Schweißtechnik Katalog
Catálogo de Soldadura para Carrocería



2
0
2
1

2
0
2
1



GYS FRANCE
Laval

🕒 1964
👤 × 530

Created in 1964, GYS is a French industrial group with 770 employees around the world. Built around continuous investment in Research & Development and in the acquisition of knowledge, the company is now a major player in the design and manufacture of welding machines, battery chargers and car body repair equipment.

“ The market realities are constantly changing and the size of our family business requires us to quickly adapt to new contexts and new challenges.

We are convinced that our future is closely linked to the future of our partners. This is why we do everything in our power to understand what distributors and users expect from us and what challenges they face every day. To support them in facing these challenges, we wish to become and remain their privileged partner on the path we will travel together. ”

Bruno Bouygues,
C.E.O.



Nicolas & Bruno Bouygues

A worldwide coverage

125 countries



visit with
📺 Youtube

INVEST IN THE FUTURE

FR

Créé en 1964, GYS est un groupe industriel français regroupant plus de 770 collaborateurs dans le monde. Fort d'un centre de recherche de premier plan, GYS est un acteur majeur dans la conception et la fabrication d'équipements de soudage, de chargeurs de batteries et de systèmes de réparation carrosserie.

Les nouvelles réalités du marché sont en perpétuel changement et la taille de notre entreprise familiale nous impose une adaptation rapide aux nouveaux contextes et à leurs enjeux.

Nous sommes convaincus que notre avenir est étroitement lié à celui de nos clients. Pour cela, nous mettons tout en œuvre pour comprendre ce que les distributeurs et les utilisateurs attendent de nous, savoir à quels défis ils font face et voir dans quelle mesure nous pouvons leur permettre de les relever afin de devenir et rester leur partenaire privilégié pour le chemin que nous avons à parcourir ensemble.

DE

GYS wurde 1964 gegründet und ist ein französisches Familienunternehmen mit mehr als 770 Mitarbeitern auf der ganzen Welt. Dank einem erstklassigen Forschungszentrum ist GYS ein wichtiger Akteur in der Entwicklung und Herstellung von Schweißgeräten, Batterieladegeräten und Karosseriereparatursystemen.

Neue Marktbedingungen sind in fortwährender Veränderung und die Größe unseres Familienunternehmens veranlasst eine rasche Anpassung an neue Umstände und an ihre Herausforderungen.

Wir sind überzeugt, dass unsere Zukunft eng mit der unserer Kunden verbunden ist. Dafür setzen wir all unser Können ein, um zu verstehen, was die Händler und Anwender von uns erwarten, welchen Herausforderungen sie gegenüberstehen und um zu schauen, in welchem Maße wir sie unterstützen können, damit wir ihr bevorzugter Partner werden und bleiben auf dem Weg, den wir gemeinsam beschreiten.

IT

Nato nel 1964, GYS è un gruppo industriale francese che raggruppa oltre 770 collaboratori nel mondo. Forte di un centro di ricerca di grande importanza, GYS è uno dei maggiori protagonisti nella progettazione e fabbricazione di apparecchiature per la saldatura e il taglio, di cariche batterie booster e avviatori e sistemi di riparazione delle carrozzerie.

Le realtà del mercato sono in continuo cambiamento e richiedono risposte immediate. Le dimensioni della nostra impresa familiare consentono un adattamento rapido ai nuovi contesti e alle loro problematiche.

Siamo convinti che il nostro futuro sia strettamente legato a quello dei nostri clienti. Per questo noi mettiamo il massimo impegno per capire quello che i distributori e i loro clienti/utilizzatori si aspettano da noi, quali sfide devono affrontare e come possiamo aiutarli per farli crescere, per diventare e restare loro partner di riferimento per proseguire insieme sul cammino del successo.



770 people



55 000 m²
590 000 sqf
2 factories

GYS GERMANY
Aachen

🕒 2006
👤 × 70

GYS U.K.
Rugby

🕒 2008
👤 × 35

GYS CHINA
Shanghai

🕒 2004
👤 × 125

GYS ITALIA
Venezia

🕒 2015
👤 × 15

Partners





GYS ACADEMY

Training centre dedicated to professionals

Centre de formation agréé

Trainingcenter für Profis

Centro di formazione dedicato ai professionisti

Ref. 52 53 0068153

3 catalogues

2700+ references



Welding & Cutting



Car body Welding Systems



Chargers, Boosters & Starters

DENT PULLING

NEW
GYSPOT
p.6

Accessories, levelling bars
p.16

Workstations
p.20

Pulling systems
p.26

Paintless repair
p.32

MOBILE PNEUMATIC LIFT

NEW
SPOT LIFT
p.34

AUTO ROLL & accessories
p.34

ERGO LIFT & accessories
p.36

TROLLEY IW1
p.37

SPOT WELDING

Overview
p.38

Traditional

PORTASPOT
p.40

GYSPOT 32D
p.40

Inverter

GYSPOT 100R
p.41

GYSPOT BP & PTI
p.42

X & C Arms
p.46

Genius

NEW
GYSPOT G
p.48

G Arms
p.52

Consumables & accessories
p.52

RIVETING

NEW
GYSPRESS
p.54

Accessories & consumables
p.58

MIG WELDING

NEW
GYS AUTO
p.64

NEW
MULTIPEARL
p.66

NEW
AUTOPULSE
p.68

Helmets, accessories & consumables
p.72

INDUCTION

NEW
GYSDUCTION COMBIDUCTION
p.78

POWERDUCTION
p.80

PLASMA

CUTTER & EASYCUT
p.84

+ MORE

Windscreen repair p.86
Bumper repair p.88
Tools p.90
Wheel repair p.95
Working lights p.96
Working supports p.98
Safety protections p.100

CHARGERS & BSU

NEW
GYSFLASH & MORE
p.102

Advanced R&D

75



Metal work
Tôlerie
Blechbearbeitung



Painting & marking
Peinture & marquage
Lackierstraße



Electronics
Électronique
Elektronik



Mechanical
Mécanique
CNC-Bearbeitung



Transformers
Transformateurs
Transformatoren



Cable work
Filerie
Kabelkonfektionierung

Assembly
Montage/tests
Montage

100%
in house
production

www.gys.fr





GYSPOT

DENT PULLING

ACIER / STEEL / STAHL

- ▼ Étoiles - Stars - Ausbeulstern
- ⌋ Anneaux - Rings - Zugösen
- 〰 Filis ondulés - Wavy wires - Wellendraht
- ⌋ Rabattage d'impact - Impact shrinking - Glätten

OPTIONS

Consommables - Consumables p.10

Chariots - Trolleys p.20



- ▼ Étoiles - Stars - Ausbeulstern
- ⌋ Anneaux - Rings - Zugösen
- 〰 Filis ondulés - Wavy wires - Wellendraht
- ⌋ Rabattage d'impact - Impact shrinking - Glätten
- + ⌋ Rétreinte - Tempering - Temperieren

NEW



FIXED GUN

FIXED GUN

GYSPOT 2600

2600 A x1 **AUTOMATIC**

230V • 1~

052208 **419,0 €HT**

included

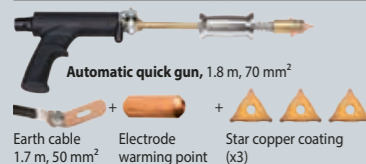

GYSPOT 2700

2600 A x1 **MANUAL**

230V • 1~

055353 **437,0 €HT**

included

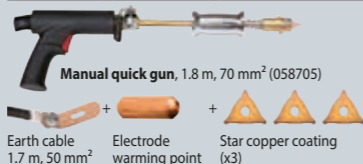

GYSPOT 34.02 & 34.04

3500 A x1 **MANUAL**

230V • 1~

GYSPOT 34.02
065741 **526,0 €HT**

NEW
04 2021

400V • 2~

GYSPOT 34.04
067943 **533,0 €HT**

NEW
04 2021

included

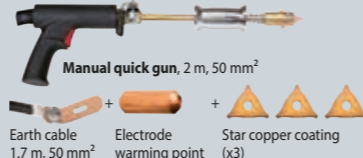

QUICK GUNS

Quick & Easy

AUTOMATIC



WITH CONNECTOR
cable 2 m, Ø 70 mm²
included 39.02/04
057517 **101,0 €HT**

included hammer :



WITH CONNECTOR
3 m, Ø 50 mm²
included PRO 230/400, COMBI 230EPRO
057500 **100,0 €HT**

WITH CONNECTOR
3 m, Ø 70 mm²
included EXPERT 200/230/400
059207 **117,0 €HT**

included hammer :



MANUAL



WITH CONNECTOR
cable 2 m, Ø 70 mm²
included PRO 230/400,
EXPERT 200/230/400,
COMBI 230EPRO
057524 **120,0 €HT**

included electrode warming point :



No connector
cable 1.8 m, Ø 70 mm²
for 2700
058705 **116,0 €HT**

included hammer :



- ▼ Étoiles - Stars - Ausbeulstern
- ⌋ Anneaux - Rings - Zugösen
- 〰 Filis ondulés - Wavy wires - Wellendraht
- ⌋ Rabattage d'impact - Impact shrinking - Glätten
- + ⌋ Rétreinte - Tempering - Temperieren
- + ⌋ Rivets - Rivets - Nieten
- + ⌋ Rondelles - Rings - Unterlegscheiben
- + ⌋ Goujons - Studs - Gewindebolzen

SYNERGIC CONTROL

PATENTS REGISTERED NUMBERS
EUROPEAN TRADEMARK & DESIGN



EXPERT SYNERGIC
★★★ & MANUAL CONTROL

Welding current adjustment Welding time adjustment



NEW DESIGN



NEW DESIGN



NEW DESIGN



GUN WITH CONNECTOR

GYSPOT 39.02 & 39.04

3800 A x1 **AUTOMATIC**

230V • 1~

GYSPOT 39.02
052215 **724,0 €HT**

400V • 2~

GYSPOT 39.04
052222 **729,0 €HT**

included

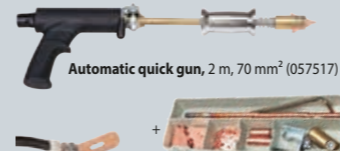

GYSPOT PRO 230 & PRO 400

3800 A x2 **AUTOMATIC**

230V • 1~

GYSPOT PRO 230
052178 **879,0 €HT**

400V • 2~

GYSPOT PRO 400
052185 **881,0 €HT**

included



GYSPOT EXPERT 200, 230 & 400

3800-4500 A x2 **AUTOMATIC**

230V • 1~

GYSPOT EXPERT 230
066885

NEW
03 2021

200-240V • 1~

GYSPOT EXPERT 200
058842 **1 361,0 €HT**

ideal

400V • 2~

GYSPOT EXPERT 400
058859 **1 244,0 €HT**

included



	CE NORM. 62135	I ₂ max	U ₂	I _{AM}	I _{RMS}	kW	MADE IN CHINA	SYNERGIC	AUTOMATIC	MANUAL	SEPARATE CABLE GUN	cm	kg	
														Hz
GYSPOT 2600	230V	2600	5,4	16	1800	10	OK	—	—	—	—	2 m	20 x 32 x 18	15
GYSPOT 2700	230V	2600	5,4	16	1800	10	OK	—	—	—	—	2 m	20 x 32 x 18	14,5
GYSPOT 34.02	230V	3500	7,4	16	2500	20	OK	OK	—	—	—	2 m	22,5 x 36 x 23,5	21
GYSPOT 34.04	400V, 2ph	3500	7,4	16	2500	20	OK	OK	—	—	—	4 m	22,5 x 36 x 23,5	21
GYSPOT 39.02	230V	3800	7,4	16	2800	20	OK	OK	—	—	—	4 m	22,5 x 36 x 23,5	22
GYSPOT 39.04	400V, 2ph	3800	7,4	16	2800	20	OK	OK	—	—	—	4 m	22,5 x 36 x 23,5	22
GYSPOT PRO 230	230V	3800	7,4	16	2800	20	OK	OK	—	—	—	8 m	22,5 x 36 x 23,5	20,5
GYSPOT PRO 400	400V, 2ph	3800	7,4	16	2800	20	OK	OK	—	—	—	8 m	22,5 x 36 x 23,5	20,5
GYSPOT EXPERT 200	200-240V	4350 > 5100	7,2-8,7	30(D)	3100 > 3600	25 > 36	OK	OK	—	—	—	8 m	22,5 x 36 x 23,5	33
GYSPOT EXPERT 230	230V	3800	7,4	16	2800	20	OK	OK	—	—	—	8 m	22,5 x 36 x 23,5	20,5
GYSPOT EXPERT 400	400V, 2ph	4500	7,4	16(D)	3200	25	OK	OK	—	—	—	8 m	22,5 x 36 x 23,5	28

GYSPOT

STEEL DENT PULLING



GYSPOT ALU

DENT PULLING

ALU

NEW DESIGN
COMING SOON

FV FLEXIBLE VOLTAGE

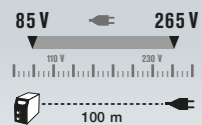

FIXED GUN

GYSPOT ALU PRO FV

100 · 230V · 1~

7500 A x1 AUTOMATIC

FV

021990 1 575,0 €HT

included



Automatic alu gun
3 m, 25 mm²



ALU BOX STANDARD (050020)
(Details p.11)

ALU GUN

AUTOMATIC

3 m, Ø 25 mm²

included ALU PRO FV
& COMBI 230
E.PRO



(x3)
065635
320er

66 mF CAPACITOR
DISCHARGE
WELDING

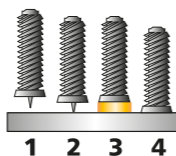

with connectors
for COMBI 230
E.PRO

PATENTS REGISTERED NUMBERS
002446450-0001
EUROPEAN TRADEMARK & DESIGN

OPTIONS

Consommables - Consumables
p.10



Accessoires ALU - ALU accessories
p.17



Chariots - Trolleys
p.20



GYSPOT COMBI

DENT PULLING

ALU + ACIER / STEEL / STAHL

NEW DESIGN
COMING SOON

3 GUNS INCLUDED



GUN WITH CONNECTOR

GYSPOT COMBI 230 E.PRO

230V · 1~

3800 A Acier / Steel / Stahl

7500 A Alu

x3

AUTOMATIC

MANUAL

AUTOMATIC

021266 2 585,0 €HT

included

Automatic quick gun, 3 m, 50 mm² (057500)

Manual quick gun, 2 m, 70 mm² (057524)

Automatic alu gun, 3 m, 25 mm²

Earth cable
2 m, 70 mm²

SPOTTER BOX PRO (050075)
(Details p.10)

ALU BOX STANDARD (050020)
(Details p.11)

MADE IN FRANCE 62135	50/60 Hz	I ₂ max A	U ₂ V	I _{AM} A	I _{RMS} A	kW	OK	OK	MANUAL	SYNERGIC	ALU	STEEL	AUTOMATIC	MANUAL	SEPARATE CABLE GUN	3m	2m	Included Alu box	21 x 24 x 36	12.5
GYSPOT ALU PRO FV	110 > 230V	7500	50 > 200	5	—	0.65	OK	OK	■	■	—	■	x1	—	—	3 m	2 m	Included Alu box	21 x 24 x 36	12.5
GYSPOT COMBI 230 E.PRO	230V	3800 (steel) 7500 (alu)	7,4 (steel) 50 > 200 (alu)	16	2800 (steel)	20	OK	OK	—	■	■	■	x2	x1	■	2/3 m	8 m	Included Spotter box + Alu box	45 x 43 x 29	42.5

GYSPOT

ALU + STEEL DENT PULLING



GYSPOT ARC PULL

DRAWN ARC

DENT PULLING

ALU + ACIER / STEEL / STAHL

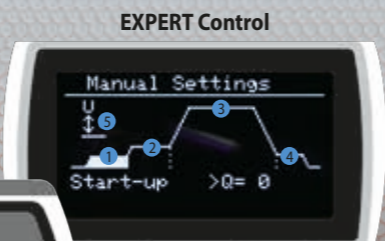
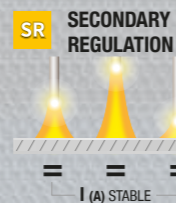

- Anneaux - Rings - Zugösen
- Goujons - Studs - Gewinbolzen
- Tiges inox - Stainless steel nails - Edelstahlnägel

- 1 Amorce - Start-up - Zündung
- 2 Décapage - Scouring (l & t) - Abbeizen
- 3 Arc (l & t) - Arc - Lichtbogen
- 4 Accroche - Hitching (l & t) - Verklebung
- 5 Hauteur - Height - Höhe

7 languages
FR, EN, DE, SR, IT,
NL & RU

SYNERGIC DIGITAL GUN



UNIQUE Linear Motor

DRAWN ARC PROCESS
Gas protection

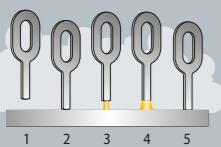

3 m, Ø 25 mm²
included
ARC PULL
200 & 350



Full control

Consumables for Gun

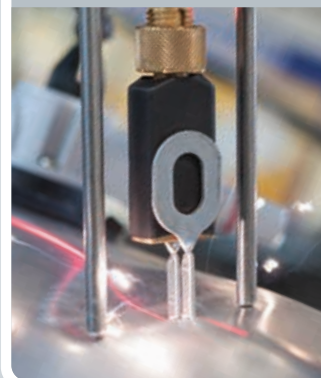

13

GYSPOT ARC PULL

DRAWN ARC DENT PULLING

PFC POWER FACTOR CORRECTION

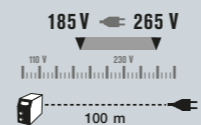

FV FLEXIBLE VOLTAGE

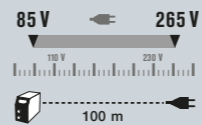

SPECIAL TEARING RIVETS

Spécial arrachage de rivets - Spezial-Zugnieten



∅ max
Alu: 6 mm
Fe: 5 mm

∅ max
Alu/Fe: 8 mm

GUN WITH CONNECTOR

GYSPOT ARC PULL 200

100 · 230V · 1~

200 A x1 MANUAL

FV SR AD

057470 3 011,0 e^{HT}

included



GYSPOT ARC PULL 350

208 · 240V · 1~

350 A x1 MANUAL

PFC SR AD

062191 3 643,0 e^{HT}

included



PACKS

ARC PULL 350 RIVET	ARC PULL 350 PULLER	ARC PULL 350 PULLER + RIVET
064645 3 951,0e ^{HT}	064652 3 803,0e ^{HT}	064669 4 111,0e ^{HT}

	Arc Pull 350	Croco T400.70	Rivet box	Alu ring box 1.5 mm	059610	Lifting rods
043787	064584	059429	059610	050792		
					x1	180, 300, 500 mm
					x1	180, 300, 500 mm

MADE IN FRANCE	CE	50/60 Hz	I ₂	SYNERGIC	TECHNOLOGY		U ₂	A	kW	OK	OK	cm	ArcPull	ArcPull + gun
					Acier/Steel	Alu								
	60974-1		A		Manual + Digital Gun Motion Control		20.4 · 24V (110V) 20.4 · 28V (230V)	16	2.4 (110V) 5.6 (230V)	OK	OK	20.5 x 25 x 33	8.6 kg	11.9 kg
			10 · 100 (110V) 10 · 200 (230V)		Manual + Digital Gun Motion Control		20.4 · 34V	16	11.9	OK	OK	30 x 24.5 x 22	11 kg	14.3 kg



GYSPOT ARC PULL

DRAWN ARC DENT PULLING

ALU + ACIER / STEEL / STAHL



NEW
05/2021



∅ max
Alu: 8 mm
Fe: 12 mm

GYSPOT ARC PULL 700

380 · 480V · 3~

680 A x1 MANUAL

SR IP 23

068315

included

- Manual synergic gun
3 m, 50 mm²
- Double earth clamps
- Arc Pull Rivet Box 700
- ALU RING BOX 1.5 mm (AlSpec + AlMg3 + AlMgSi)
059429
- Lifting rod 180 mm (x1)
- Gas protection (x1)
068346
- Threaded studs holder
∅ 6 (x1) 068391
∅ 8 (x1) 068407

SYNERGIC DIGITAL GUN

★ ★ ★ ★ ★
**UNIQUE
Linear
Motor**

**DRAWN ARC
PROCESS**

**Ideal
all position**



3 m, ∅ 50 mm²
included ARC PULL 700

GYSPOT ARC PULL 200 & 350 - ACCESSORIES & CONSUMABLES

ACIER / STEEL / STAHL

x1 059634 21€HT	x1 059641 94€HT	x1 064065 50€HT	x100 064065 50€HT	x100 064034 10€HT	x2 049000 36€HT	x100 059603 11€HT	x100 049000 36€HT	x100 048157 16€HT	x100 049383 11€HT	x100 049383 11€HT	x100 049420 10€HT	x1 048164 16€HT	x100 063969 29€HT	x200 063990 94€HT	x1 064041 17€HT	x200 064003 119€HT	x1 064058 23€HT	x100 063976 57€HT
STEEL STUDS BOX 350 059443 186€HT	x1	x1			x1	x100			x1	x100	x100	x100						

ALU

x1 059634 21€HT	x1 059641 94€HT	x2 049000 36€HT	x100 049000 36€HT	x1 048157 16€HT	x100 048157 16€HT	x1 048164 16€HT	x100 048164 16€HT	x200 064010 95€HT	x1 064041 17€HT	x200 064027 121€HT	x1 064058 23€HT	x100 063983 22€HT
ALU STUDS BOX 350 059436 184€HT	x1	x1	x1	x100	x1	x100	x1	x100				

box 059412 57€HT	box 059429 59€HT	box 065703 13€HT	1mm x100 059535 12€HT	1.5mm x100 059559 12€HT	2mm x100 065703 13€HT	1mm x100 059498 11€HT	1.5mm x100 059511 13€HT	1mm x100 059450 13€HT	1.5mm x100 059474 15€HT	1mm x50 059542 32€HT	1.5mm x50 059566 30€HT	1mm x50 059504 28€HT	1.5mm x50 059528 32€HT	1mm x50 059467 32€HT	1.5mm x50 059481 32€HT
ALU RING BOX 1 mm 059412 57€HT	ALU RING BOX 1.5 mm 059429 59€HT	ALU RING BOX 2 mm 065703 13€HT	1mm x50	1.5mm x50	1.5mm x50	1mm x50	1.5mm x50	1mm x20	1.5mm x20	1mm x20	1.5mm x20	1mm x20	1.5mm x20	1mm x20	1.5mm x20

x1 064591 240€HT	x1	x1	x1
STUDS HOLDER BOX 350 064591 240€HT			Joint rings for mandrel ∅ 4/5/6 x 2 064591 240€HT

x100 064607 137€HT	x1 059634 21€HT	x1 059634 21€HT	x1 059641 94€HT	x1 049000 36€HT	x2 049000 36€HT	x1 067721
ARC PULL RIVET BOX 350 064584 251€HT	x100	x1	x1	x1	x2	

GYSPOT ARC PULL 700 - ACCESSORIES & CONSUMABLES

x100 064607 137€HT	x1 067721	x1 059634 21€HT	x1 059641 94€HT	x1 059641 94€HT	x1 059610 71€HT	x2
ARC PULL RIVET BOX 700 068452	x100	x1	x1	x1	x1	x2

	MADE IN FRANCE		60974-1		I ₂	SYNERGIC		U ₂		kW				cm		ArcPull	ArcPull + gun
GYSPOT ARC PULL 700				50/60 Hz	A		Manual + Digital Gun Motion Control	20.4 · 44 V	20 A (D) 16 A (D)	35 kW	OK	OK	32 x 32.4 x 41	16 kg	19.3 kg		



FAST DENT PULLING



ACIER / STEEL / STAHL

EASY TOOL CONNECTION

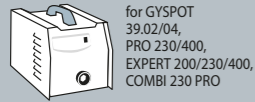

for GYSPT
39.02/04,
PRO 230/400,
EXPERT 200/230/400,
COMBI 230 PRO

051690
118,0 €HT

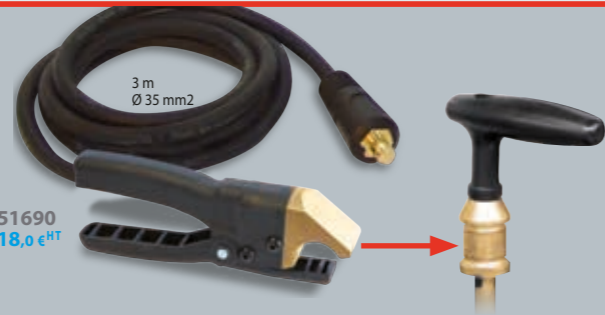

3 m
Ø 35 mm²

051584 66,0 €HT 380 g	Anneaux - Rings - Anschweißösen 051652 62,0 €HT	Fils ondulés - Wavy wires - Wellendraht 051669 58,0 €HT	Rétreinte - Tempering - Glättwerkzeug 051676 65,0 €HT	EASYGUN 051317 57,0 €HT	Box of 3 electrodes for accessories 050822 41,0 €HT	Poignée de tirage manuel 057289 65,0 €HT
--------------------------	-------------------------------------------------------	---------------------------------------------------------------	-------------------------------------------------------------	-------------------------------	-----------------------------------------------------------	---------------------------------------------

MANUSPOT

050679 566,0 €HT



Tools set & support for SPOT 600, 800, 1000, 1600, Workstation & Dentstation

EASYGUN
051317 57,0 €HT

MANULINER

050471 356,0 €HT



Patents registered numbers 001652108-0003 EUROPEAN TRADEMARK & DESIGN

MANULINER/GUN

056831 222,0 €HT



Adaptateur pistolet - Gun adapter included
052499 15,0 €HT

Direct impact electrodes (x5)
050839 19,0 €HT

Patins - Pads (x2)
051317 57,0 €HT

Patents registered numbers 001652108-0003 EUROPEAN TRADEMARK & DESIGN

FAST & EASY



RINGMATIC

052154 169,0 €HT

included (x 50)



Option Adaptateur pistolet - Gun adapter
052499 15,0 €HT

LAMPE LIGNE DROITE

- Straight line lamp
- Dentline-laser

056770
161,0 €HT



QUICK SPOT AIR GUN V2

057340 594,0 €HT

LIGHT
920 g



2,5 m

QUICK SPOT AIR GUN V2 + Mini-fraiseuse - Mini-Druckluftfräser

065567 721,0 €HT

057340 + 063228



Included Tungsten drill Ø 6 mm
054172 54,0 €HT

Adaptateur pistolet - Gun adapter
052826 39,0 €HT

ALU

ARC PULLER PREMIUM

ULTRA RESISTANT
No deformation

Full rotation
GRIP

Multi positions



065161
323,0 €HT

Included Alu 3
065178 34,0 €HT

Included Alu 4
065185 30,0 €HT

ALU PULLER

051003 195,0 €HT



4 positions
4 Positionen

Mini Puller
050921

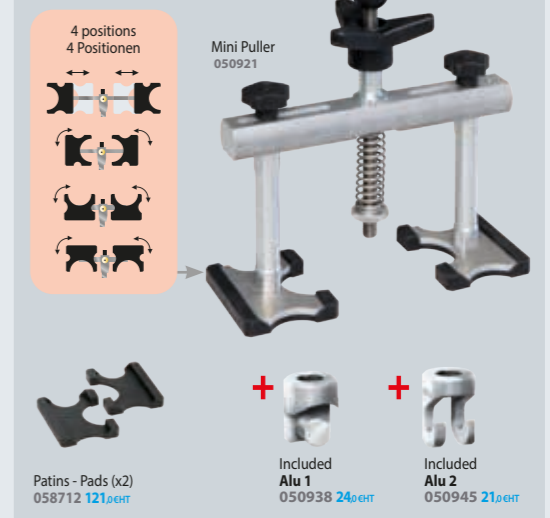

Patins - Pads (x2)
058712 121,0 €HT

Included Alu 1
050938 24,0 €HT

Included Alu 2
050945 21,0 €HT

ANNEAUX DE TIRAGE RAPIDE

- Fast pulling rings

058743 162,0 €HT



x5
058712
121,0 €HT

Alu 1
050938
24,0 €HT

Alu 2
050945
21,0 €HT



Marteau à inertie
380 g
050051 54,0 €HT

MARTEAUX ALU

- Alu hammers

020986
198,0 €HT



ASPIRATEUR PNEUMATIQUE POUR POUSSIÈRES ALUMINIUM (ATEX) - Pneumatic alu dust atex vacuum cleaner

058866 1 806,0 €HT

Capacity : 25 l
Working air pressure : 6 bar
Air consumption at 6 bar : 800 l/min
Suction connection : 50 mm
Max suction capacity : 150 m³/h
Max vacuum level : 2000 mm H₂O
Recommended compressor power : 7.5 HP
↳ 74 x 45 x 45 mm
▲ 18 kg

included
Filtre - Filter
058873
111,0 €HT

included
Sac - Bag
5 kg
058880
79,0 €HT

5 m
Output Ø 29 mm
Input Ø 35 mm



MARTEAUX INERTIE
- Slide hammers - Ausbeulhammer

COMPLETE
057272 **60,0 €HT**



1,1 kg
049802
49€HT

included (x1)
049482 16€HT

included (x20)
050839 19€HT

Options (x1)
054028 16€HT

(x5)
050839 19€HT

Clous - Nails - Nägel



1,1 kg
041813
113,0 €HT

Ø 2, M4 (x1)
049802 49€HT

Ø 2 (x100)
049802 49€HT

MIG/MAG nozzle
for Nail welding
041523 18,7€HT

Rondelles - Washers - Ringe



1,7 kg
051201 **68,0 €HT**

Ø 16, 8x16 (x1)
041523 18,7€HT

(x1)
041523 18,7€HT

8x16 (x100)
041523 18,7€HT

COMPLETE KIT
051225 **182,0 €HT**

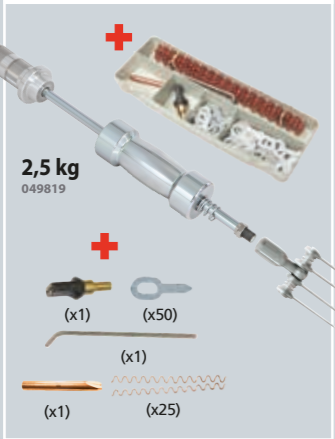

2,5 kg
049819

(x1) (x50)

(x1) (x25)



6 kg
051928 **121,0 €HT**

Kit marteau à inertie - Inertia hammer kit
- Ausbeulhammerkit

STANDARD

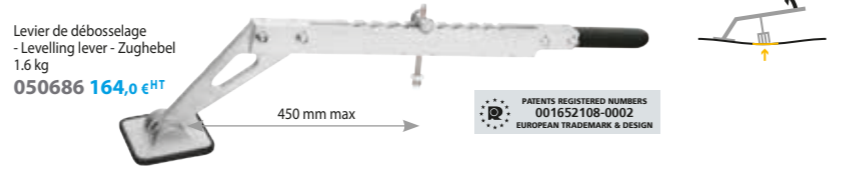

Levier de débousselage
- Levelling lever - Zughebel
1.6 kg
050686 **164,0 €HT**

PATENTS REGISTERED NUMBERS
001652108-0002
EUROPEAN TRADEMARK & DESIGN

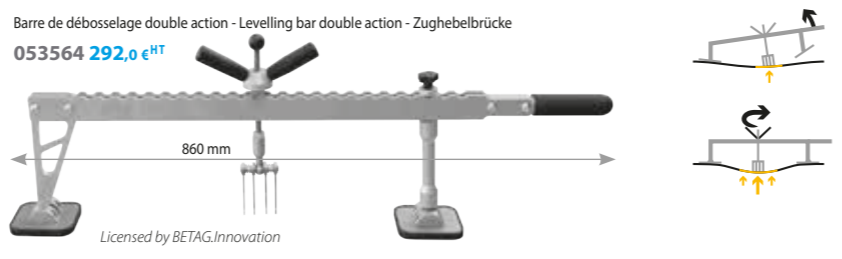

Barre de débousselage double action - Levelling bar double action - Zughebelbrücke
053564 **292,0 €HT**

Licensed by BETAG.Innovation



Barre de débousselage - Levelling bar - Zugbrücke
3.4 kg
050693 **366,0 €HT**

Licensed by BETAG.Innovation

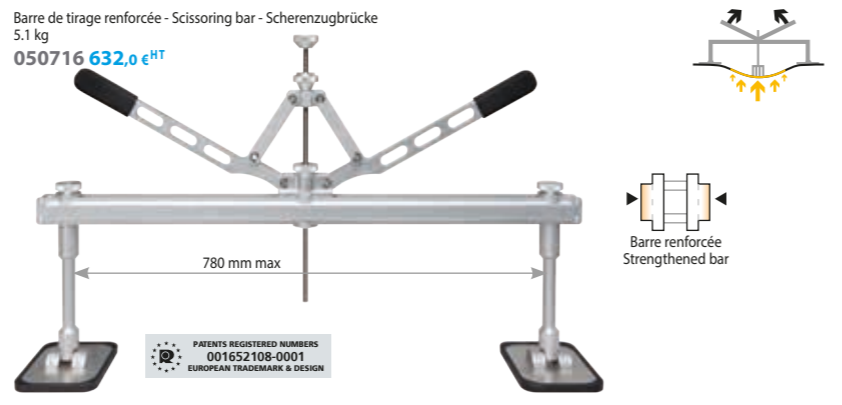

Barre de tirage renforcée - Scissoring bar - Scherenzugbrücke
5.1 kg
050716 **632,0 €HT**

Barre renforcée
Strengthened bar

PATENTS REGISTERED NUMBERS
001652108-0001
EUROPEAN TRADEMARK & DESIGN

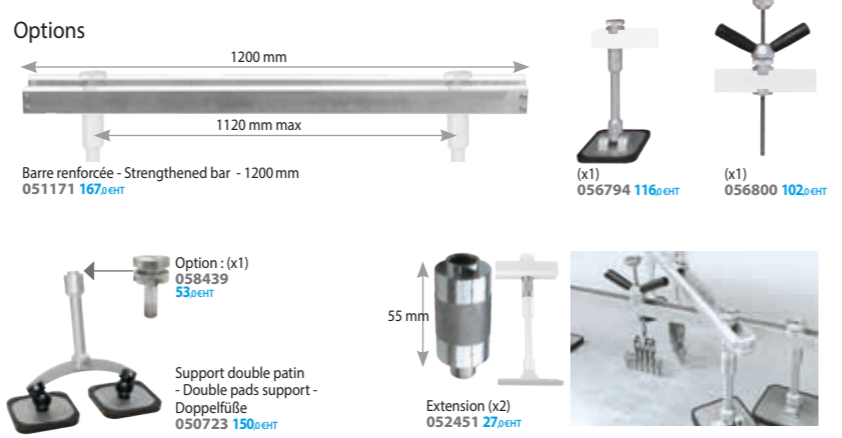

Options

1200 mm
1120 mm max

Barre renforcée - Strengthened bar - 1200 mm
051171 **167€HT**

(x1)
056794 **116€HT**

(x1)
056800 **102€HT**

Option : (x1)
058439 **53€HT**

Support double patin
- Double pads support -
DoppelfüÙe
050723 **150€HT**

55 mm
Extension (x2)
052451 **27€HT**

PREMIUM

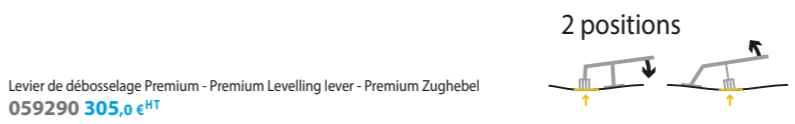

Levier de débousselage Premium - Premium Levelling lever - Premium Zughebel
059290 **305,0 €HT**

2 positions

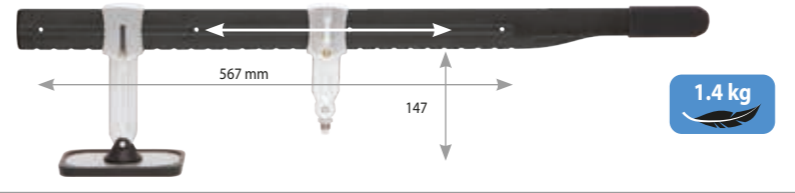

1.4 kg

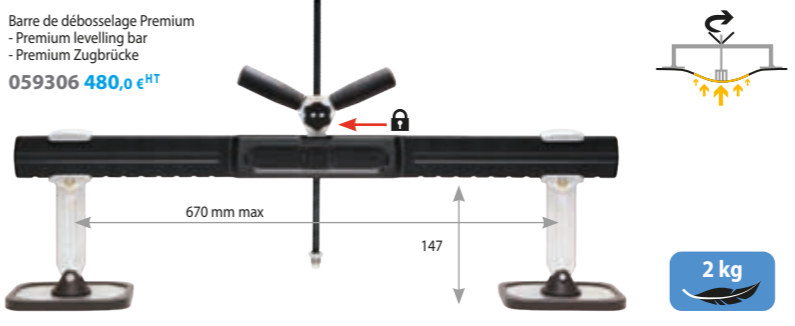

Barre de débousselage Premium
- Premium levelling bar
- Premium Zugbrücke
059306 **480,0 €HT**

2 kg

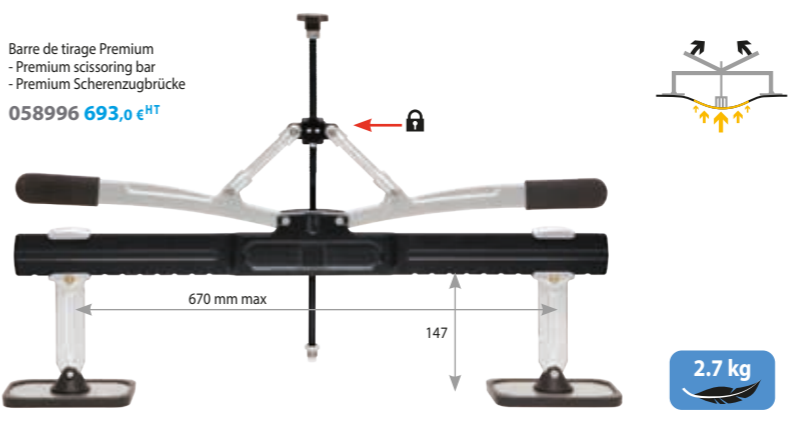

Barre de tirage Premium
- Premium scissoring bar
- Premium Scherenzugbrücke
058996 **693,0 €HT**

2.7 kg

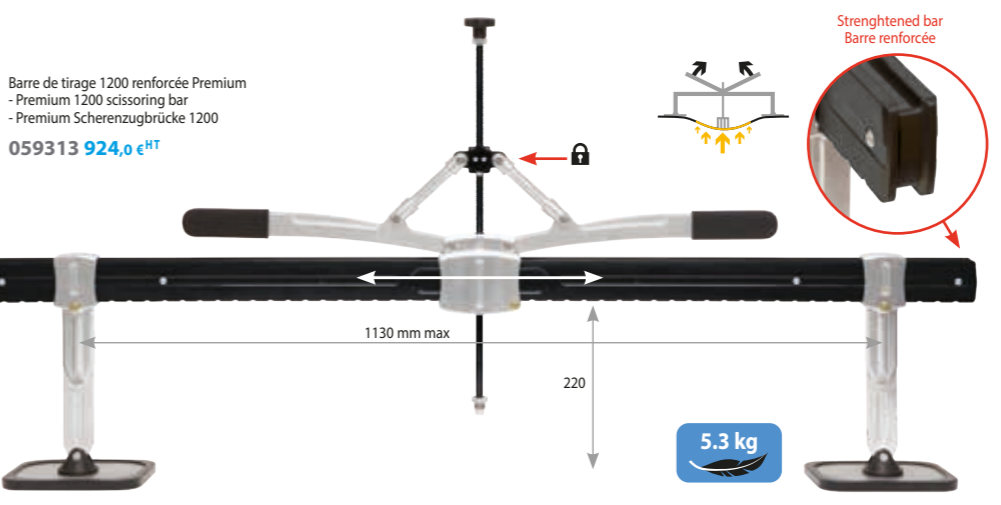

Barre de tirage 1200 renforcée Premium
- Premium 1200 scissoring bar
- Premium Scherenzugbrücke 1200
059313 **924,0 €HT**

5.3 kg

Strengthened bar
Barre renforcée



Arc Puller Premium
065161 **323,0€HT** **NEW**

Included :
Alu 3 065178 **34€HT** **NEW**
Alu 4 065185 **30€HT** **NEW**



Poignée de tirage 3 dents
- Pulling handle 3 claws -
Handzugkralle 3-fach
057326 **104€HT**



Poignée de tirage 2 dents
057319 **65€HT**



Alu Puller
051003 **195€HT**



Mini Puller
050921

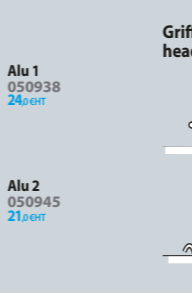

Alu 1
050938 **24€HT**

Alu 2
050945 **21€HT**

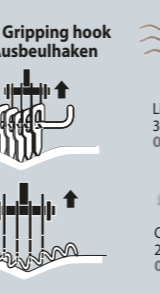

Griffes - Gripping hook
head - Ausbeulhaken

Lifting rods 180,
300 & 500 mm
050792 **19€HT**

Curved lifting rod
280 mm
064706 **17€HT**



Compatibility: **BASIC** **PREMIUM**

2-teeth
hook
057296
30€HT



Premium
2-teeth hook
059382
28€HT

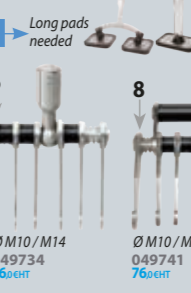

Premium
3-teeth hook
059658
66€HT

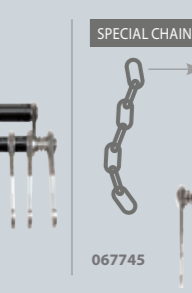

Long pads
needed



SPECIAL CHAIN
NEW
Ø M10/
M14
067745

ULTRA LIGHT

ULTRA ERGONOMIC

ULTRA RESISTANT
No deformation

PERFECT BALANCE

Slide & Lock

Full rotation

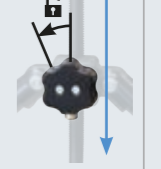
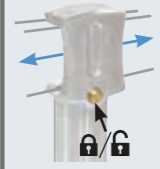

Multi positions



Options



059320
114€HT



x1 059337 **114€HT**
x2 061293 **208€HT**



059399
137€HT



x1 059344 **144€HT**
x2 059351 **274€HT**



x1 059368 **167€HT**
x2 059375 **310€HT**



CHARIOTS - Trolleys



Spot 600
053533 **130,0 €HT**

Universal 800
051331 **226,0 €HT**



Spot 1000
053540 **199,0 €HT**

Spot 1600
051348 **480,0 €HT**



Dentstation PRO
056848 **721,0 €HT**

Housse de protection
- Protection cover
- Schutzhaube
for Universal 800
062733 **129,0 €HT**
for Spot 1600
048881 **165,0 €HT**
for Dentstation Pro
059870 **226,0 €HT**

Cable support for
Spot 800,
1600
& Dentstation
052284
80,0 €HT

Compatibility

GYSPT	Spot 600	Spot 1000	Spot 800	Universal 800	Spot 1600	Dentstation Pro
2600, 2700	✓	✓	✓		✓	✓
34.02/04	✓	✓	✓		✓	✓
3902/04	✓	✓	✓		✓	✓
PRO 230/400	✓	✓	✓		✓	✓
EXPERT 200/230/400	✓	✓	✓		✓	✓
ALU PRO FV	✓		✓		✓	✓
COMBI 230 E PRO				✓	✓	✓
ARCPULL 200/350				✓	✓	✓



DENT PULLING WORKSTATIONS

**UNE SOLUTION COMPLÈTE
A COMPLETE SOLUTION
KOMPLETTLÖSUNGEN**

EASYLINER

			ALL IN 1 BOX
GYSPT (guns & consumables included)	SPOT 1000 053540	Levelling bar double action 053564 + Dent box easy 053632	
39.02 053618 1 247,0 €HT	GYSPT 39.02	✓	

PROLINER

GYSPT (guns & consumables included)	UNIVERSAL 800 051331	Cable support 052284	Levelling bar double action 053564 + Dent box bar 050037
39.02 035775 1 374,0 €HT	GYSPT 39.02	✓	✓
39.04 035782 1 379,0 €HT	GYSPT 39.04	✓	✓
PRO 230 035799 1 646,0 €HT	GYSPT PRO 230	✓	✓
PRO 400 035805 1 649,0 €HT	GYSPT PRO 400	✓	✓
GYSPT (guns & consumables included)	UNIVERSAL 800 051331	Cable support 052284	Alu puller 051003
ALU PRO FV 035836 2 115,0 €HT	GYSPT ALU PRO FV	✓	✓
GYSPT (guns & consumables included)	Weld 810 037489	Cable support 052284	Arc puller premium 065161
ARC PULL 200 065260 3 717,0 €HT	GYSPT ARC PULL 200	✓	✓



✓ 39.02

EASYLINER ACIER / STEEL / STAHL



✓ 39.02, 39.04
✓ PRO 230, PRO 400

PROLINER ACIER / STEEL / STAHL



✓ ALU PRO FV

PROLINER ALU



✓ ARC PULL 200

ALU (ACIER / STEEL / STAHL)

SPEEDLINER

GYSPT (guns & consumables included)	SPOT 1600 051348	Cable support 052284	Fixing kit 051362	Levelling bar 050693	Multihook heads 049758	Alu Box 05 & 6 048195	Alu puller 051003	Alu hammers 020986	Set of pencil punches with 6 teflon tips 052888	Mini disc sander 051829	051423	Infrared Thermometer 052994	Thermal marking pencil 052765

ALU PRO FV 036055 3 682 _{CHF}	GYSPT ALU PRO FV												
--------------------------------------------------	----------------------------	--	--	--	--	--	--	--	--	--	--	--	--

GYSPT (guns & consumables included)	SPOT 1600 051348	Cable support 052284	Manuspot 050679	Levelling bar 050693	Levelling lever 050686	052451	Multihook heads 049758+049734	3 lifting rods 050792	Dent box consumables 051515	Magnetic earth 049666	Ringmatic 052154	Alu puller 051003	Arc puller premium 065161	4 m³ support 059665

39.02 035010 2716 _{CHF}	GYSPT 39.02													
39.04 035027 2722 _{CHF}	GYSPT 39.04													
PRO 230 036017 3 065 _{CHF}	GYSPT PRO 230													
PRO 400 036024 3 068 _{CHF}	GYSPT PRO 400													
EXPERT 200 028180 3 585 _{CHF}	GYSPT EXPERT 200													
EXPERT 230 066984	GYSPT EXPERT 230													
EXPERT 400 028197 3 459 _{CHF}	GYSPT EXPERT 400													

COMBI 230 E.PRO 036062 4 999 _{CHF}	GYSPT COMBI 230 E.PRO	✓	×2											
ARC PULL 200 + EXPERT 200 065284 7 140 _{CHF}	GYSPT ARC PULL 200 + EXPERT 200													
+ EXPERT 230 066991	GYSPT ARC PULL 200 + EXPERT 230	✓	×2										✓	✓
+ EXPERT 400 065291 7 015 _{CHF}	GYSPT ARC PULL 200 + EXPERT 400													
without generator	035058 1 937 _{CHF}													

SPEEDLINER PREMIUM

GYSPT (guns & consumables included)	SPOT 1600 051348	Cable support 052284	Fixing kit 051362	Premium levelling bar 059306	Hook head 059382	3 lifting rods 050792	Alu Ring Box 1 mm 059412	Arc puller premium 065161	Alu hammers 020986	Set of pencil punches with 6 teflon tips 052888	Infrared Thermometer 052994	4 m³ support 059665

ARC PULL 200 065277 5 005 _{CHF}	GYSPT ARC PULL 200											
----------------------------------------------------	------------------------------	--	--	--	--	--	--	--	--	--	--	--

GYSPT (guns & consumables included)	SPOT 1600 051348	Cable support 052284	Manuspot 050679	Ringmatic 052154	Manual pulling handle 057289	Premium levelling bar 059306	Premium levelling lever 059290	220 mm pads 061293	Hook head 049758 + 059658 + 059382	3 lifting rods 050792	Dent box consumables 051515	Magnetic earth 049666	Fast pulling rings (x5) 058712 + Alu puller 051003	Arc puller premium 065161	4 m³ support 059665

PRO 230 028265 3 656 _{CHF}	GYSPT PRO 230														
PRO 400 028272 3 659 _{CHF}	GYSPT PRO 400														
EXPERT 200 028289 4 176 _{CHF}	GYSPT EXPERT 200														
EXPERT 230 067004	GYSPT EXPERT 230														
EXPERT 400 028302 4 050 _{CHF}	GYSPT EXPERT 400														

COMBI 230 E.PRO 028319 5 717 _{CHF}	GYSPT COMBI 230 E.PRO	✓	×2											
ARC PULL 200 + EXPERT 200 065307 7 731 _{CHF}	GYSPT ARC PULL 200 + EXPERT 200													
+ EXPERT 230 067011	GYSPT ARC PULL 200 + EXPERT 230	✓	×2										✓	✓
+ EXPERT 400 065314 7 605 _{CHF}	GYSPT ARC PULL 200 + EXPERT 400													



✓ ALU PRO FV

SPEEDLINER ALU

- ✓ 39.02, 39.04
- ✓ PRO 230, PRO 400
- ✓ EXPERT 200, EXPERT 230, EXPERT 400

ACIER / STEEL / STAHL



- ✓ COMBI 230 E.PRO
- ✓ ARC PULL 200 + EXPERT 200
- ✓ ARC PULL 200 + EXPERT 230
- ✓ ARC PULL 200 + EXPERT 400

SPEEDLINER PREMIUM

ALU + ACIER / STEEL / STAHL



COMPLETE SYSTEM

- ✓ COMBI 230 E.PRO
- ✓ ARC PULL 200 + EXPERT 200
- ✓ ARC PULL 200 + EXPERT 230
- ✓ ARC PULL 200 + EXPERT 400

SPEEDLINER ALU + ACIER / STEEL / STAHL



✓ ARC PULL 200

SPEEDLINER PREMIUM

- ✓ PRO 230, PRO 400
- ✓ EXPERT 200, EXPERT 230, EXPERT 400

ACIER / STEEL / STAHL



DENTSTATION

--	--	--	--	--	--	--	--	--	--	--	--	--	--	--	--

39.02 028012 4338_{eff}	GYSPT 39.02					✓									
39.04 028029 4344_{eff}	GYSPT 39.04														
PRO 230 036420 4505_{eff}	GYSPT PRO 230														
PRO 400 036437 4508_{eff}	GYSPT PRO 400														
EXPERT 200 036734 5025_{eff}	GYSPT EXPERT 200					✓									
EXPERT 230 067028	GYSPT EXPERT 230														
EXPERT 400 036741 4899_{eff}	GYSPT EXPERT 400														
COMBI 230 E.PRO 036444 6439_{eff}	GYSPT COMBI 230 E.PRO	✓	x2				✓								
ARC PULL 200 + EXPERT 200 065321 8592_{eff}	GYSPT ARC PULL 200 + EXPERT 200														
+ EXPERT 230 067035	GYSPT ARC PULL 200 + EXPERT 230	✓	x2			✓									✓
+ EXPERT 400 065338 8467_{eff}	GYSPT ARC PULL 200 + EXPERT 400														

DENTSTATION PREMIUM

--	--	--	--	--	--	--	--	--	--	--	--	--	--

PRO 230 028067 6109_{eff}	GYSPT PRO 230														
PRO 400 028074 6112_{eff}	GYSPT PRO 400														
EXPERT 200 036758 6629_{eff}	GYSPT EXPERT 200					✓									
EXPERT 230 067042	GYSPT EXPERT 230														
EXPERT 400 036765 6503_{eff}	GYSPT EXPERT 400														
COMBI 230 E.PRO 036772 8170_{eff}	GYSPT COMBI 230 E.PRO	✓	x2				✓								
ARC PULL 200 + EXPERT 200 065345 10197_{eff}	GYSPT ARC PULL 200 + EXPERT 200														
+ EXPERT 230 067059	GYSPT ARC PULL 200 + EXPERT 230	✓	x2			✓						✓	✓		
+ EXPERT 400 065352 10071_{eff}	GYSPT ARC PULL 200 + EXPERT 400														



DENTSTATION ACIER / STEEL / STAHL

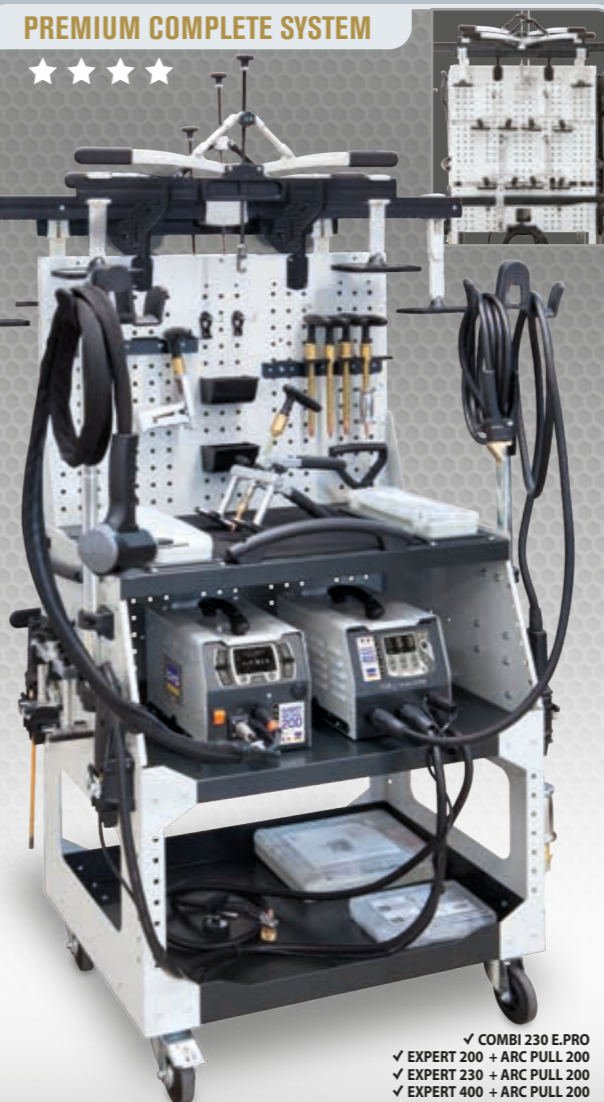

DENTSTATION PREMIUM ALU + ACIER / STEEL / STAHL

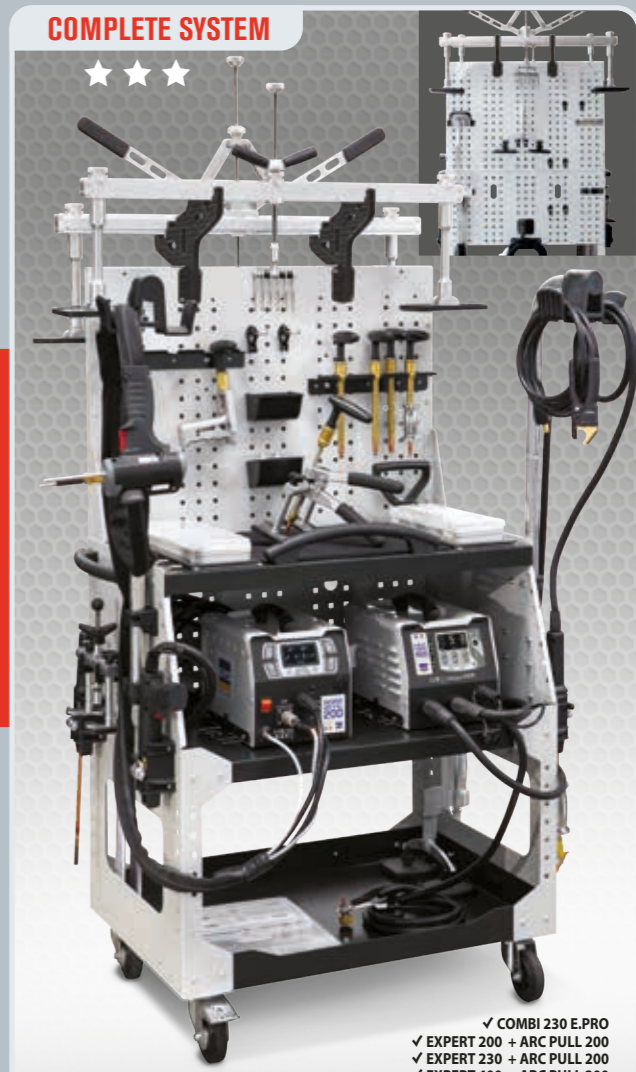

DENTSTATION ALU + ACIER / STEEL / STAHL

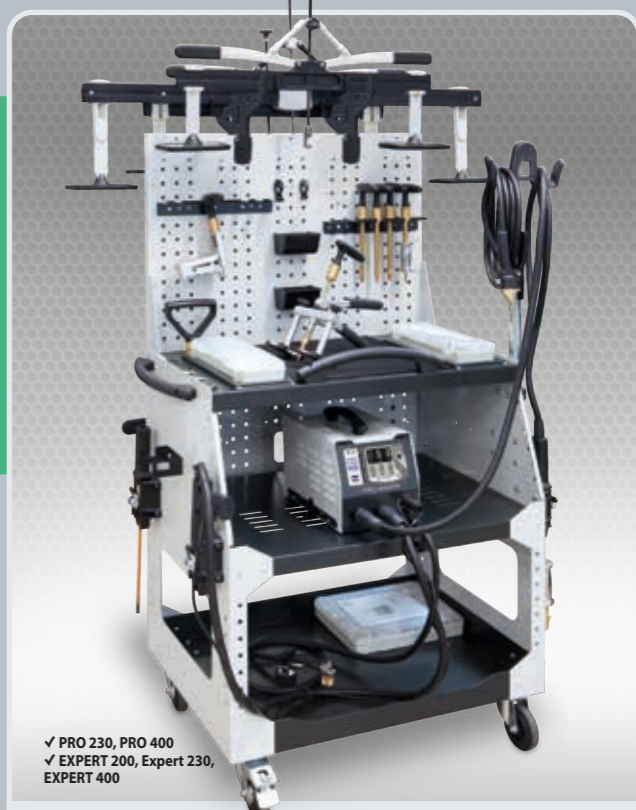

DENTSTATION PREMIUM ACIER / STEEL / STAHL

✓ 39.02, 39.04
✓ PRO 230, PRO 400
✓ EXPERT 200,
EXPERT 230, EXPERT 400

✓ COMBI 230 E.PRO
✓ EXPERT 200 + ARC PULL 200
✓ EXPERT 230 + ARC PULL 200
✓ EXPERT 400 + ARC PULL 200

✓ COMBI 230 E.PRO
✓ EXPERT 200 + ARC PULL 200
✓ EXPERT 230 + ARC PULL 200
✓ EXPERT 400 + ARC PULL 200

✓ PRO 230, PRO 400
✓ EXPERT 200, Expert 230,
EXPERT 400

PULLING SYSTEMS

ÉQUERRE DE TIRAGE

- Draw aligner - Schnellausbeul-Richtausleger

052475 990,0 €HT

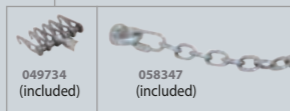
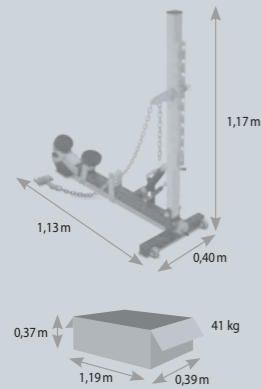
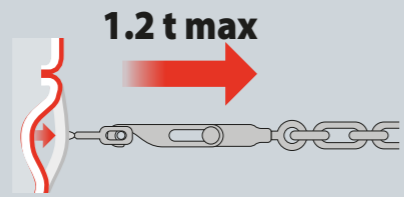

OPTIONS

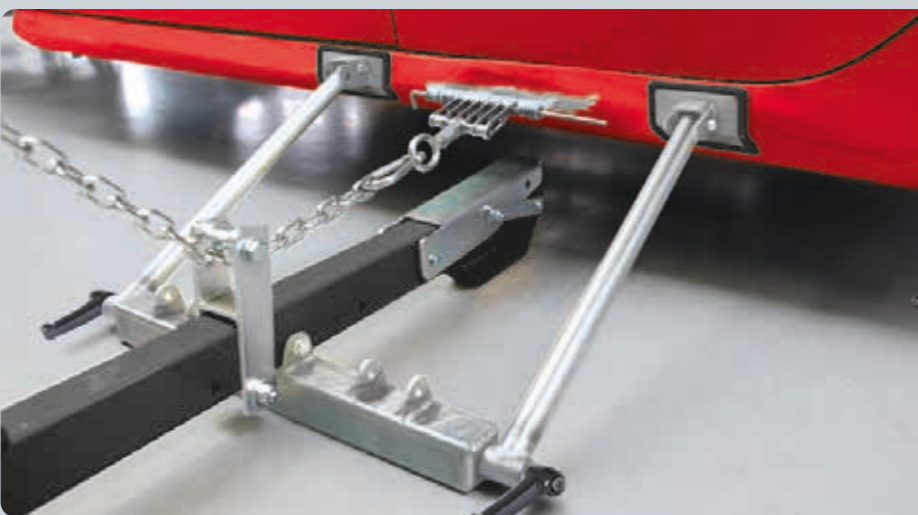
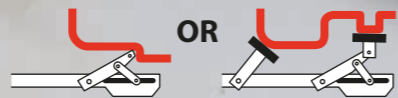

OPTIONS

Bras de bas de caisse - Rocker panel arms for draw aligner - Abstütztraverse für Richtausleger



7 kg

052581 242€HT

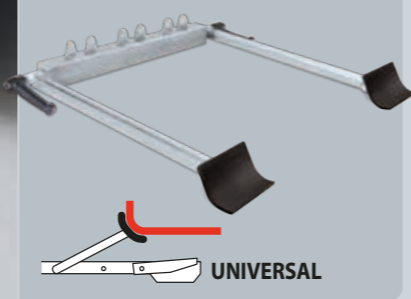

SYSTÈME DE TIRAGE SMART PULLER SILVER

- Smart puller silver pulling system - Schnellausbeul-Richtausleger Smart puller silver

054820 2 847,0 €HT

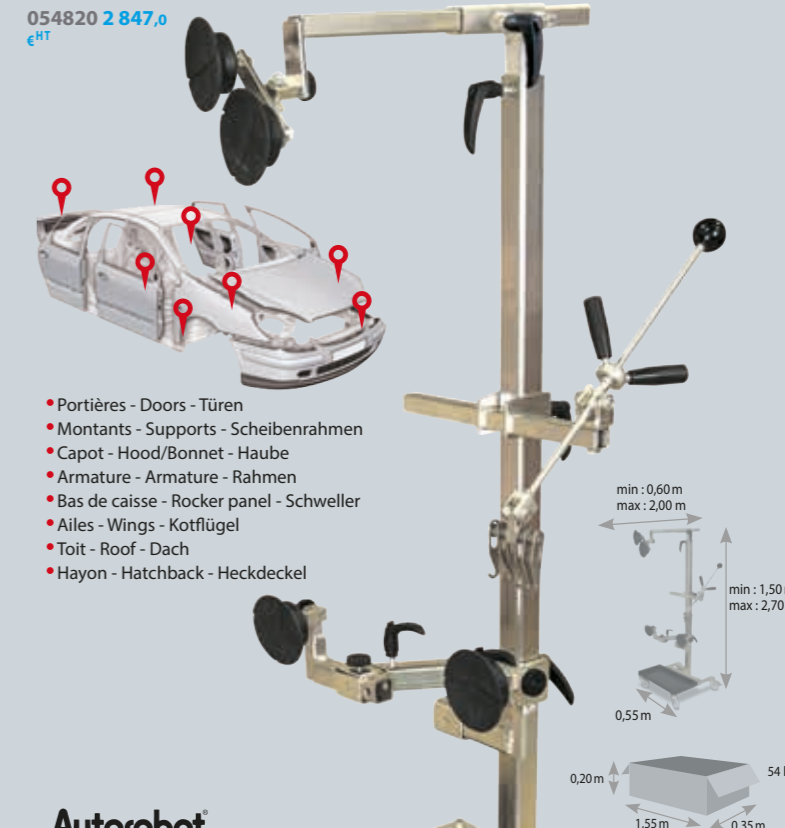
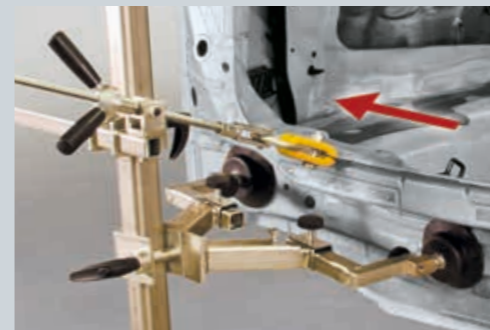
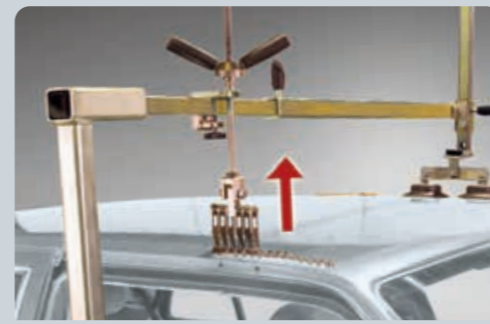

- Portières - Doors - Türen
- Montants - Supports - Scheibenrahmen
- Capot - Hood/Bonnet - Haube
- Armature - Armature - Rahmen
- Bas de caisse - Rocker panel - Schweller
- Ailes - Wings - Kotflügel
- Toit - Roof - Dach
- Hayon - Hatchback - Heckdeckel

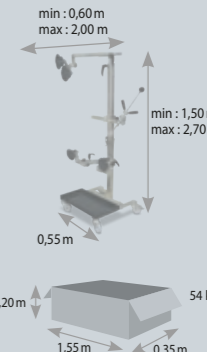

Autorobot

INCLUDED

Accessories



Spreading / Estensione

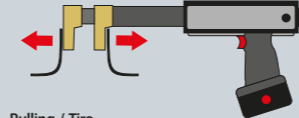

Pressing / Compressione



Pulling / Tiro

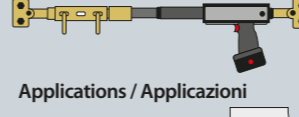

Pushing / Spinta



Applications / Applicazioni

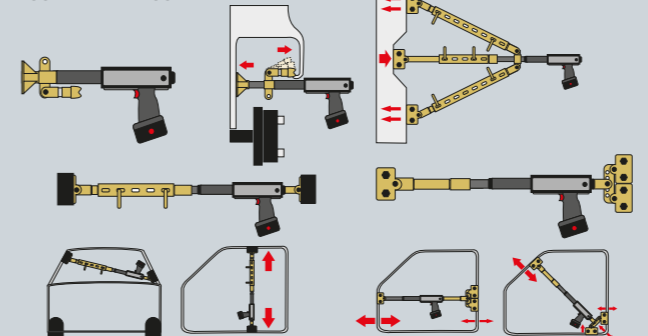

ELECTRO POWER - Zug-Druckpresse

with accessories: 057425 2 423€HT

-PULLING POWER: 5 Ton.
-PUSHING POWER: 5 Ton.
-PISTON STROKE: 130 mm



INCLUDED



Li-Ion battery (included) 058514 174€HT



BASIC 4T
052345 185,0 €HT



BASIC 10T
052338 267,0 €HT

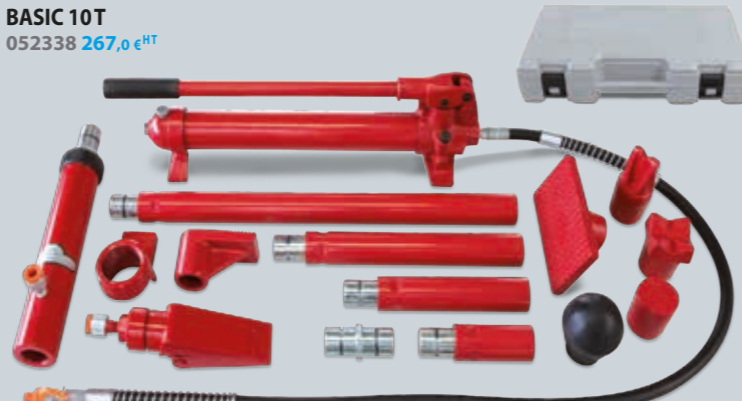

PRO 4T
057432 302,0 €HT



PRO 10T
057449 447,0 €HT



OPTIONS



Huile hydraulique 1L
- Hydraulic oil 1L
053397 27€HT

BARRE D'ANCRAGE - Anchor bar - Türspanner

053045 229,0 €HT

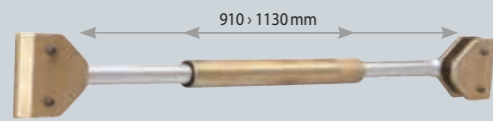

053052 264,0 €HT



MESURES - Measuring tools - Vermessung

BODYMETER, Mechanical measurements

052130 721,0 €HT

250 > 2230 mm



GYSMETER, Electronic measurements

052093 1 486,0 €HT

400 > 2650 mm



Measuring report

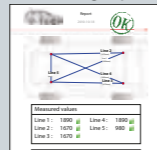

Light weight measuring arm with an easy to read digital display

SATELLITE INTELLIGENT - Smart Satellite - Satellite Komplett-Kit

The best from **Autorobot**
www.autorobot.com/pdf/7148_ENG.pdf
MADE IN FINLAND

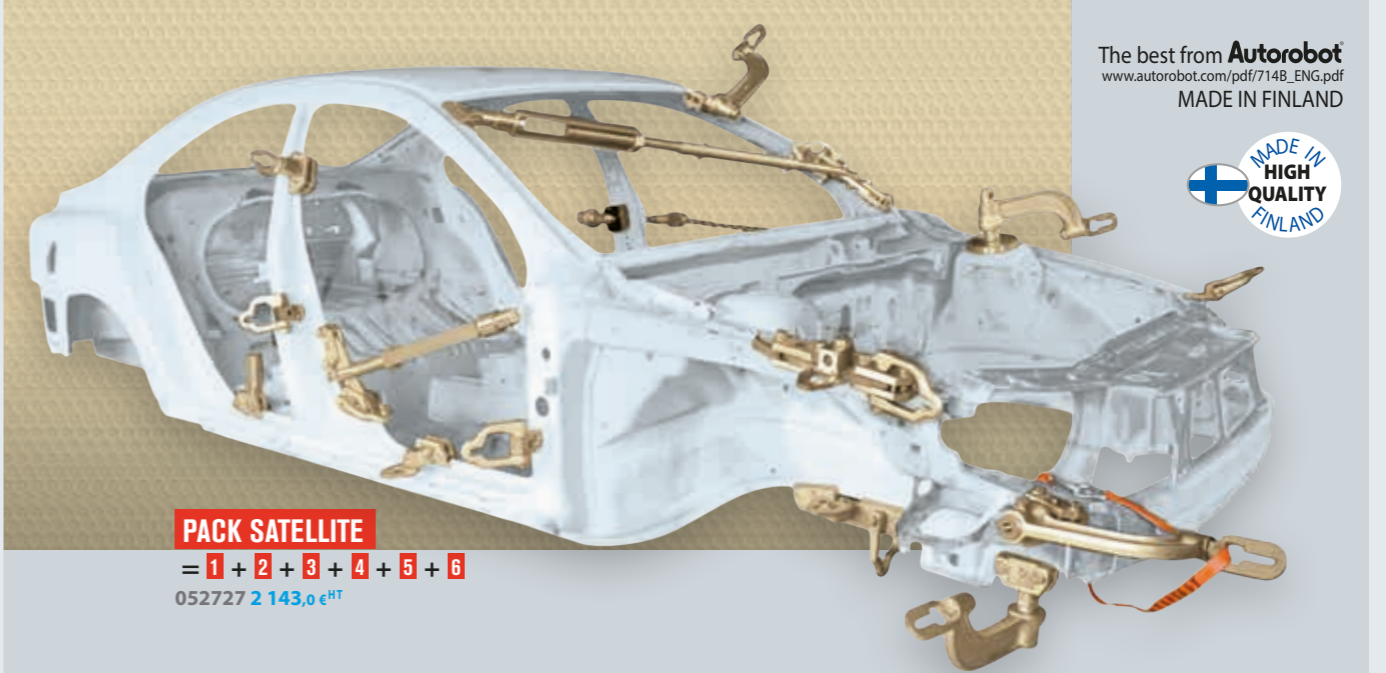

PACK SATELLITE

= 1 + 2 + 3 + 4 + 5 + 6

052727 2 143,0 €HT

1 SATELLITE
- Satellite - Satellite Basisbügel-Set

052710 640€HT



2 KIT MAC PHERSON (A)
- Mac Pherson Kit - Befestigungskit-Federbein (McPherson)

052703 328€HT



3 BARRE POUR TIRER/POUSSER
- Push/Pull Bar - Zug/Druck-Stangenset

052673 427€HT

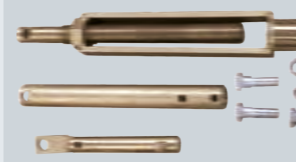

4 SATELLITE (B)
- Bügelverlängerung

052680 215€HT

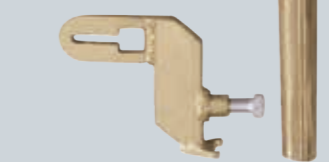

5 SANGLE DE SÉCURITÉ
- Safety Strap - Sicherungsgurt

044036 41€HT



6 DOUBLE PINCE SATELLITE (C)
- Double Clamp Satellite - Satellite Doppelklemme

052697 493€HT



PINCE DE TIRAGE MULTI-USAGE
- Versatile pulling clamp - Multifunktions-Zugklemme

053571 213€HT

Autorobot



POWER-PULLER 4T

059740 116,0 €HT



HIGH QUALITY

CROCHET DE TIRAGE - Frame Straightening - Ziehwerkzeuge

Kit crochet de tirage « boomerang »
- Boomerang pulling hook set
- Zughaken Set «Boomerang»

052659 **194,0 €^{HT}**

PINCES DE TIRAGE - Frame Straightening - Ziehwerkzeuge

Mini pince de tirage a blocage manuel
- Manual-locking pull clamp
- Mini Klemme von Auflage in Handblockieren

056855 **77,0 €^{HT}**

5 t

Pince de tirage à blocage automatique
- Self-locking pull clamp
- Selbstklemmende Zugklemme

052642 **166,0 €^{HT}**

6 t

max 12 mm

PINCE PIVOTANTE - Swivel clamp

060968 **168,0 €^{HT}**

6 t

Pince de tirage à blocage automatique
- Self-locking pull clamp
- Selbstklemmende Zugklemme

060944 **168,0 €^{HT}**

6 t

Pince de tirage à angle droit
- Right angle pull clamp
- Zugklemme 90° Winkel

052666 **166,0 €^{HT}**

6 t

PINCES DE TIRAGE LARGES - Wide pull clamps

Pince de tirage large 2 directions
- 2-way wide serrate clamp

061217 **150,0 €^{HT}**

5 t

3 t

120 mm

Pince de tirage large multidirections
- Multi-way wide serrate clamp

061224 **174,0 €^{HT}**

5 t

3 t

120 mm

PINCE DE TIRAGE MULTIPLE - Multiple pull clamp

Pince multiple répartition de charge
- Load spread multi clamp

060999 **259,0 €^{HT}**

5 t

120 mm

450 mm

PASSAGE DE ROUE - Arch hooks

Crochet passage de roue petite dimension
- Small arch hook

060975 **63,0 €^{HT}**

1.5 t

155 mm

Crochet passage de roue grande dimension
- Large arch hook

060982 **65,0 €^{HT}**

1.5 t

315 mm

PINCES DE TIRAGE FAIBLE LARGEUR - Small pull clamps

Pince bec de canard
- Long nose clamp

060951 **66,0 €^{HT}**

2 t

245 mm

30 mm

Pince de tirage faible largeur
- Small mouth pull clamp

061231 **59,0 €^{HT}**

5 t

210 mm

45 mm

Pince contournement de rebord
- Box clamp

061170 **74,0 €^{HT}**

3 t

220 mm

35 mm

CHAÎNES DE TIRAGE - Frame Straightening - Ziehwerkzeuge

Chaîne de tirage 10 mm
Body chain 10 mm

061255 **153,0 €^{HT}**

2,5 m

Charge de rupture - Breaking load - Zuglast : 12 t

Raccord de chaîne double crochet
- Chain joint double grab hook

061156 **53,0 €^{HT}**

6 t

210 mm

Raccord de chaîne pour deux pinces
- Chain joint for two clamps

061163 **56,0 €^{HT}**

280 mm

NEW

067745

Ø M10/
M14

KIT MARTEAU À INERTIE - Inertia hammer kit - Ausziehhammer kit

Kit marteau à inertie
- Inertia hammer kit
- Ausziehhammer kit

051928 **121,0 €^{HT}**

6 kg

67 cm

M17

Marteau à inertie 6+3 kg avec griffe de chaîne
- Inertia hammer 6+3 kg with chain hook
- Ausziehhammer 6+3 kg

061194 **366,0 €^{HT}**

6+3 kg

94 cm

Ø 20 mm

19 cm



Débosselage rapide et sans peinture
- PDR: Paintless Dent Repair
- Lackschadenfreies Ausbeulen

PAINTLESS DENT REPAIR



Youtube



MADE IN FRANCE

50 Hz	A	W	kHz	PFC	FV	Liquid Cooling	Cable (m)	Inductor	cm	kg
230V, 1~	16	2.400	35+120	■	■	—	2	2,5	22 x 36 x 27	7,5

INDUCTEUR DÉBOSSÉLAGE

- Dent Pulling Inductor - Dellenmatrix

GYSDUCTION AUTO DENT REPAIR
054981 1 308,0 €HT

GYSDUCTION AUTO + Dent pulling inductor
054776 338,0 €HT



Licensed by BETAG.Innovation

OPTION
Spray refroidisseur - Freezer spray
-50 °C
400 ml
(x 12) 048898 148,0€HT

INSPECTION CARROSSERIE

- Dent Pulling Inductor - Ausbeul-Matrix

Planche flexible pour inspection de la carrosserie - Ausbeul-Matrix
Ø 800 mm

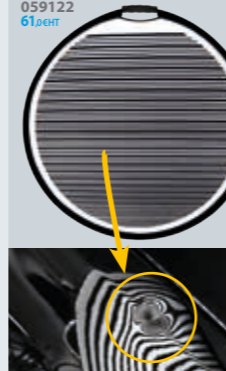

KIT MAGNÉTIQUE DE DÉBOSSÉLAGE SANS PEINTURE

- Paintless Dent Repair magnetic kit - Magnetisches Ausbeul-Kit

053168 2 184,0 €HT **EXELTOOLS**

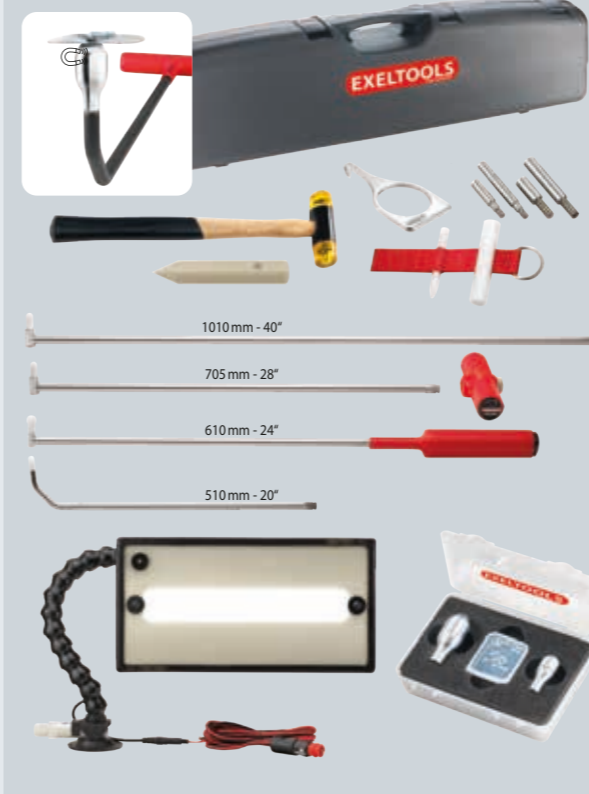

LAMPES DE DÉBOSSÉLAGE

- Paintless Dent Repair lamps - Ausbeullampe

056749 146,0 €HT
Made in Taiwan



ULTRA LIGHT CARBON X40 PW

053175 551,0 €HT **EXELTOOLS**



GLUE PULLER PRO (Acier/Alu - Steel/Alu)

MADE IN FRANCE

Glue Puller PRO
058699 290,0 €HT

Glue Puller PRO EXPORT
059160 269,0 €HT

Glue Lifter 057364 149,0€HT

061392 17,0€HT

050952 21,0€HT (x6)
Ø 16

Ø 21

Ø 32

250 W 052901 55,0€HT

x10 050976 14,0€HT

050983 24,0€HT

BARRETTES ANNEAUX PLASTIQUE - Plastic Multipads Ösen-Klebe pads

(x3) 048089 90,0€HT

(x3) 048119 90,0€HT

(x3) 048072 90,0€HT

(x3) 048102 90,0€HT

(x3) 048096 91,0€HT

Ref. 050945

Colle Glue

156 mm

OPTIONS

057302 65,0€HT

050051 54,0 €HT

057906 82,0 €HT

057913 72,0 €HT

acier-steel-Stahl 1.6 kg

KIT DÉBOSSÉLAGE SANS PEINTURE

- Dent Pulling Kit (paintless) - Dellenausbeulhebel-Set

33 parts

051959 531,0 €HT

Paintless Dent Repair Kit

KIT DE 6 COINS DE FRAPPE - Set of 6 pencil punches - Beulenstemmer-Satz mit 6 Tefloneinsätzen

052888 97,0 €HT

MADE IN FRANCE

MARTEAU INERTIE PNEUMATIQUE - Pneumatic inertia hammer - Unterdruck-Schlaghammer

2,5kg

Ø 60 (x1)

Ø 120 (x1)

Ø 150 (x1)

051904 193,0 €HT

KIT COUSSINS GONFLABLES

- Air Cushion Kit - Luftpolster-Spreizkissen-Satz

051942 96,0 €HT

MARTEAU À INERTIE À VENTOUSES (POMPAGE MANUEL)

- PUMP AIR SUCTION SLIDE HAMMER - Man. Unterdruck-Schlaghammer

1,1kg

Ø 75 (x1)

Ø 100 (x1)

Ø 125 (x1)

048683 224,0 €HT



SPOT LIFT

MOBILE LIFTS

SPOT LIFT EASY

max Air 8 bar

SAFE EN 1494

max 2.2 t



064843 1 703,0 €HT

HEALTH CARE

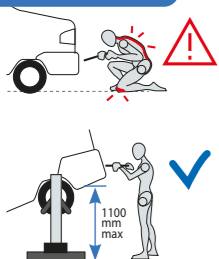

Haute stabilité - High stability



Included
220 bar
053588
538,0€HT

NEW

SAFE
EN 1494

OPTIONS



Huile hydraulique - Hydraulic oil 1 l
053397 27,0€HT



Outil de levage pour bas de caisse - Rocker panel lifting tool - Auflage für Seitenschweller
053236 112,0€HT



84 kg

1,27 m

0,89 m

0,76 m

0,27 m

93 kg

1,20 m

0,77 m



SPOT LIFT PRO

max Air 8 bar

SAFE EN 1494

max 2.2 t



053557 2 425,0 €HT

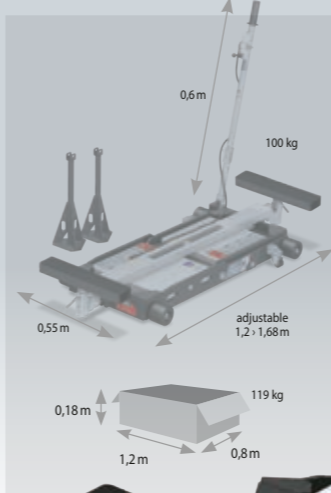

SAFE
EN 1494

60 cm (max)
14 cm (min)

SPOT LIFT PRO MOB

max Air 8 bar

SAFE EN 1494

max 2.2 t



055896 2 962,0 €HT

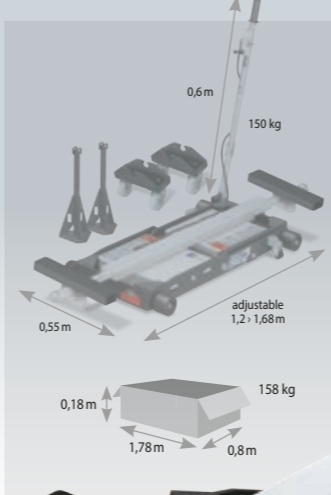

60 cm (max)
14 cm (min)



SAFE
EN 1494

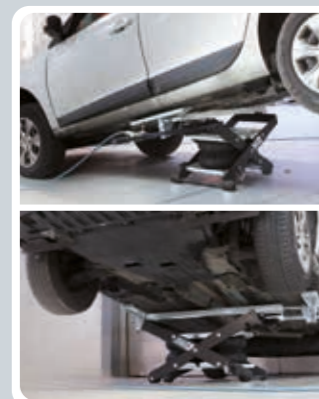

OPTIONS

Réhausseur pour 4x4 et utilitaires - Height adjuster for 4x4 & utility vehicles - Erhöhung f. 4x4 und Leicht-LKW



Patins - Pads for Audi & BMW (x 2)
053717 95,0€HT

Rampes - Ramps 700 x 200 x 80 mm (x 2)
056787 46,0€HT



OPTIONS

SPOT LIFT PRO MOB Réhausseur pour 4x4 et utilitaires - Height adjuster for 4x4 & utility vehicles - Erhöhung f. 4x4 und Leicht-LKW



Patins - Pads for Audi & BMW (x 2)
061606 132,0€HT

Rampes - Ramps 700 x 200 x 80 mm (x 2)
056787 46,0€HT

AUTO ROLL



2.5 t max

min 500 mm
max 1700 mm (AUTOROLL 1.0m)
max 2240 mm (AUTOROLL 1.55m)

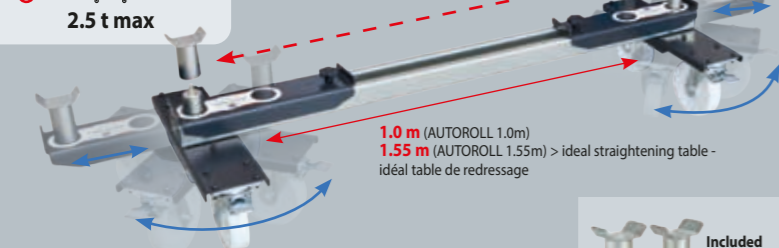

1.0 m (AUTOROLL 1.0m)
1.55 m (AUTOROLL 1.55m) > idéal straightening table - idéal table de redressement

AUTO ROLL 1.0 m / 1.2 t
059047 640,0 €HT

AUTO ROLL 1.55 m / 1.2 t
063839 695,0 €HT

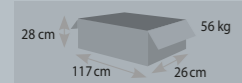

AFTER LIFT AUTO ROLL

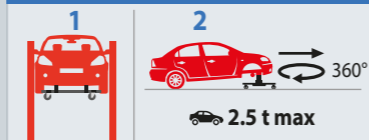

2.5 t max

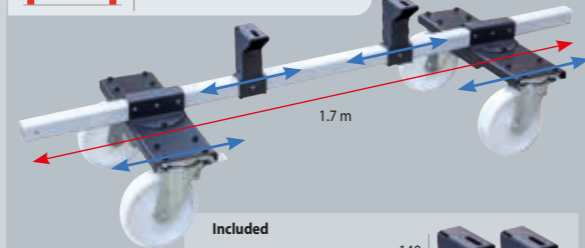

067967
45 Kg

NEW
03/2021



TABOURETS DE MANUTENTION - Wheel trolleys - Radhocker

048768 381,0 €HT



26 cm max

250 mm

650 kg max

CHARIOTS DE MANUTENTION PRISE SOUS ROUE - Wheel trucks - Kfz-Montagelift, fahrbar

053243 371,0 €HT

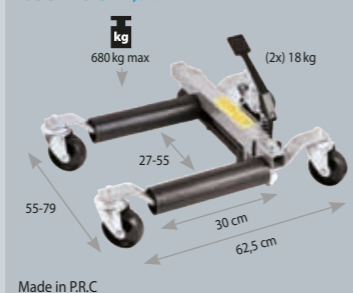

680 kg max

(2x) 18 kg

55-79

27-55

30 cm

62,5 cm

Made in P.R.C

Chariots mécaniques (x 2) - Mechanic jacks (x2)
064126 371,0 €HT



680 kg max

(2x) 15 kg

61-80 cm

34-71

33 cm

68 cm

Made in P.R.C

Option Support - Stand
064133 39,0 €HT



35

SPOT LIFT

MOBILE LIFTS

ERGO LIFT 650

220 V, 1~ **SAFE EN 1493**

max 2 t



Youtube

056817 4 592,0 €^{HT}



220 V, 1 ph
0,75 kW

Included
Huile hydraulique -
Hydraulic oil
5l
062160 74^{€HT}



Pack ERGO LIFT 650
+ 4 Wheel trolleys (x4)

068544

NEW



QUICK LIFT L520E

062184 1 885,0 €^{HT}

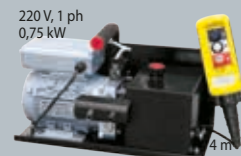

220 V, 1 ph
0,75 kW

Included
Huile hydraulique -
Hydraulic oil
5l
062160 74^{€HT}



Youtube

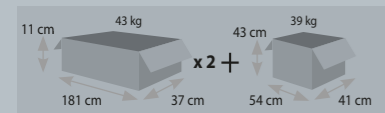

Made in China



OPTIONS

Patins pour SUV -
Pads for SUV
x4
065017 194^{€HT}



Extensions 1680 mm
x 2
066328 394^{€HT}



NEW

AIR JACKS



MANUAL WHEEL LIFT

Lève roue à treuil
- Wheel lift trolley
- Radmontage-Heber
061385 704,0 €^{HT}

min : R13 / 135 / 65
max : R22 / 300 / 35
40 kg max

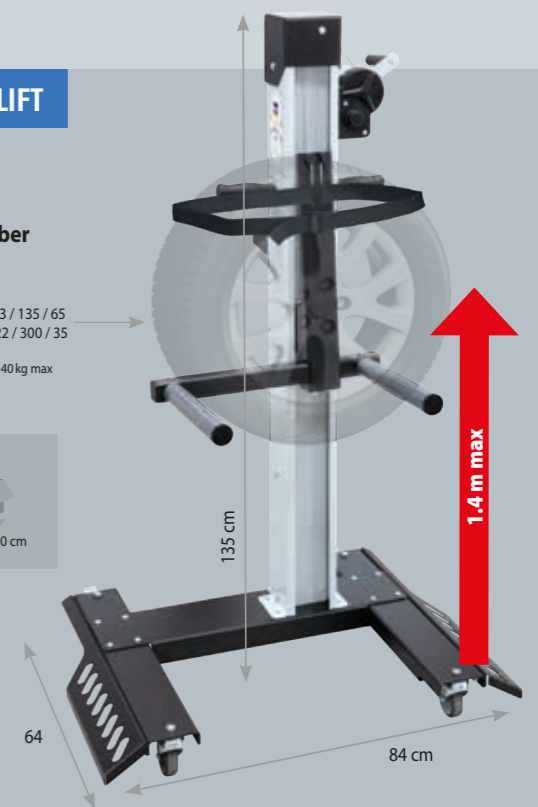
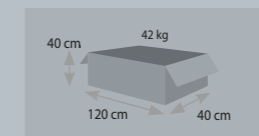

TROLLEY IW1

max 6.5 bar

6.5 bar

063136 1 788,0 €^{HT}



Youtube



Liberté de mouvement
- High dexterity

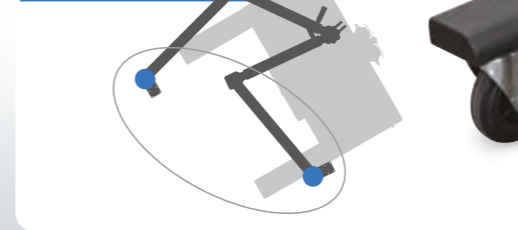

Grande maniabilité et stabilité
- High maneuverability & stability



OPTIONS

Huile hydraulique
- Hydraulic oil
1l
053397 27^{€HT}



Clé à choc
- Impact wrench
max 20 kg

Fixation
36 x 36 mm
→ 44 x 44 mm

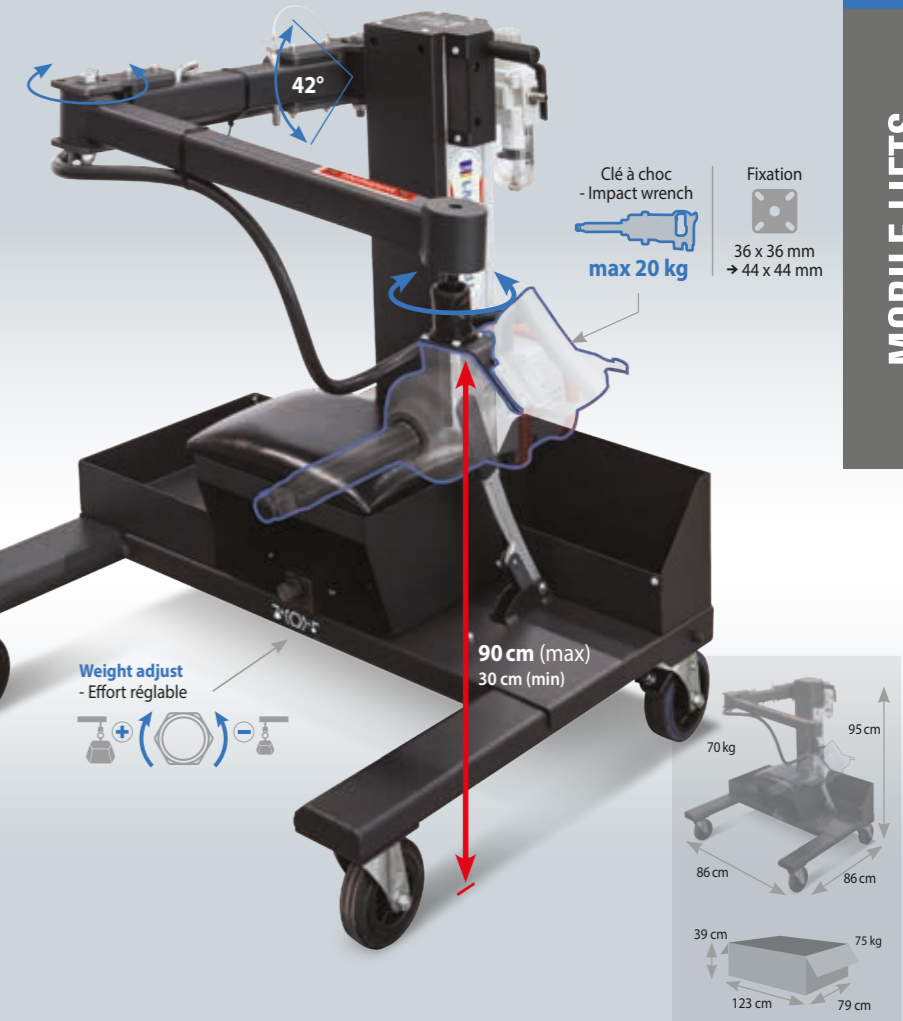

ÉVOLUTION TECHNOLOGIQUE

TECHNICAL IMPROVEMENTS - TECHNISCHE ENTWICKLUNG - MEJORAS TECNICAS

2004
 Facteurs d'évolution :
 • Challenge CO2 = faible poids
 • Crash test = ★★★★★
 • Anti corrosion = nouveaux revêtements
 • Esthétique et visibilité plus sophistiquées.

2022
 Evolution factors :
 • CO2 Challenge = low weight
 • Crash test = ★★★★★
 • Anti-corrosion = new coatings
 • Improved aesthetics and demand for better occupant visibility.

2022
 Entwicklungsfaktoren :
 • CO2 Challenge = geringes Gewicht
 • Crash-Test = ★★★★★
 • Anti-Korrosion = neue Beschichtung
 • Modernes Technik-Design.

2022
 Fattori di evoluzione :
 • Sfida CO2 = basso peso
 • Crash test = ★★★★★
 • Nuovi rivestimenti = anticorrosivi
 • Estetica e visibilità più sofisticate

2004

OLD SOLUTIONS

Traditional machines
 180 daN max
 6 500 A max
 X clamps
 Ø 4 mm max

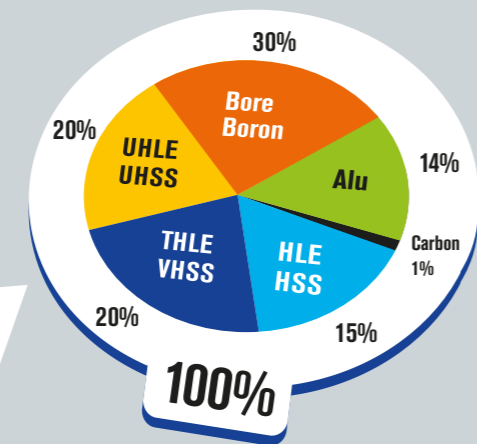
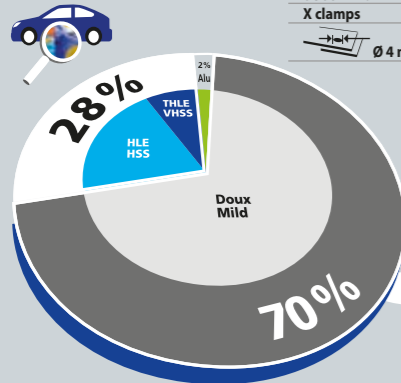

2022

GYS SOLUTIONS

INVERTER Technology
 550 daN max
 14 500 A max
 X & C clamps
 Liquid cooled system
 Ø 10 mm



Exemple de carrosserie nouvelle génération
 • An example of new generation car body
 • Beispiel einer Karosserie der neuen Generation
 • Esempio di carrozzeria di nuova generazione

- Mild - Doux
- HSS - HLE
- VHSS - THLE
- UHSS - UHLE
- Bore - Boron
- Aluminium

HOMOLOGATIONS PRODUITS

MANUFACTURER APPROVALS / COMPLIANCE - PRODUKT HOMOLOGATIONEN - PRODOTTI APPROVATI



Machine	Volkswagen Group	Jeep	Mercedes	Smart	Volvo	GM	Tata	Renault	Nissan	Toyota	Honda	Ford	Honda USA	NIO
DENT PULLER														
GYSPT 2600/2700														
GYSPT 39.02/04, PRO230/400, EXPERT 200/400														
PROLINER/SPEEDLINER/DENTSTATION														
GYSPT ALU FV														
ARCPULL 200														
RESISTANCE SPOT WELDERS														
GYSPT 32D														
GYSPT INVERTER 100R														
GYSPT INVERTER BP-LX														
GYSPT INVERTER BP-LC-s7														
GYSPT INVERTER BP-LCX-s7														
GYSPT INVERTER BP-LG														
GYSPT EVOLUTION PTI-s7														
VAS 821 101 - Spot Welder														
BIVE TING														
GYPRESS 8T														
MIG / MAG														
T1 GYS AUTO														
T3 GYS AUTO														
AUTOPULSE 220-M3														
AUTOPULSE 320-T3														
VAS 821 005 - Pulse MIG Welder														
VAS 821 00580 023														
PLASMA														
CUTTER 25K/35KF														
CUTTER 30FV/45CT														
INDUCTIION														
GYSDUCTION AUTO														



RANGE

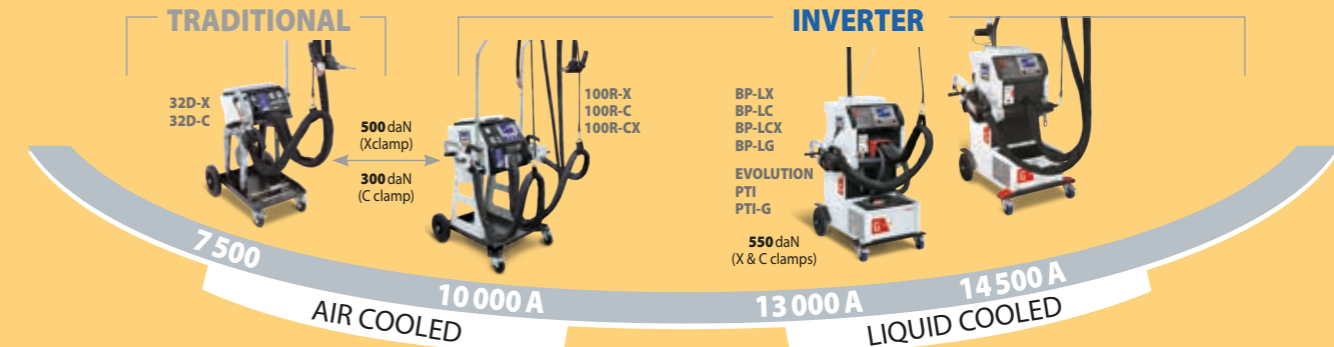

	32 D	100 R	BP / BP-LG	PTI	PTI-G
Doux - Mild	•	•	•	•	•
HLE/THLE - HSS/VHSS	Difficult	•	•	•	•
UHLE/BORE - UHSS/BORON	Difficult	Difficult	•	•	•
Nombre de points - Number of spots					
→ 0,8 + 0,8 mm	100	150	no limit	no limit	
→ 2,5 + 2,5 mm	10	15	120	120	
Inverter Technology	—	•	•	•	•
EMF Directive 2013/35/UE	—	—	BODY PROTECT TECHNOLOGY	•	•
Système de refroidissement - Cooling system	AIR	AIR	LIQUID	LIQUID	LIQUID
Régulation automatique - Automated regulation	I (A) daN irregular	• • constant	• • constant	• • constant	• • constant
MODE AUTO	—	—	• (LC, LCX, LG)	•	•
Pince - Clamp	X C X+C	• (32DX) • (32DC)	• (100R-X) • (100R-C) • (100R-CX)	• (BP.LX) • (BP.LC, BP.LG) • (BP.LCX)	— — —
Transformer Inside Clamp	—	—	—	•	•
Cables (L)	2,5 m	2,5 m	2,5 m	4 or 6 m	6 m
Includes gun	•	•	•	option	option
Cadence de soudage maximale (points/min) - Max welding frequency (spots/min)					
→ 0,8 + 0,8 mm	10	10	10	10	10
→ 2,5 + 2,5 mm	6	10	2	6	10
Fuse	400 V 200/208-240 V	32 A	40 A	32 A 40 A 50 A	32 A 40 A 50 A
				25 A (14 500 A) 16 A (11 500 A)	40 A (14 500 A) 32 A (11 500 A)

BP BODYPROTECT TECHNOLOGY 2013/35/UE
 UNIQUE ELECTRO-MAGNETIC FIELD PROTECTION by GYS

LA SOLUTION GLOBALE - THE GLOBAL SOLUTION

®BODY PROTECT is a proprietary GYS technology that minimises electromagnetic fields created by the machine.
 Compliant : Directive 2013/35/UE
 Certified by : Laboratory EMITECH
 MADE IN FRANCE

Other technologies	GYS BODYPROTECT TECHNOLOGY
B1: 10 < 25 cm (Norm : 3 cm max)	B1: 0 cm (Norm : 3 cm max)
B2: 25 < 35 cm (Norm : 30 cm max)	B2: 5 cm (Norm : 30 cm max) / 4 cm (Norm : 30 cm max)
B3: 35 cm (Norm : 20 cm max)	B3: 0 cm (Norm : 20 cm max)
B4: 35 cm (Norm : 20 cm max)	B4: 0 cm (Norm : 20 cm max)

SPOT WELDING

PORTASPOT 230
6 300 A 120 daN
 Air cooled

230V
 022256 **1 156,0 €HT**



ARMS Ø 23 mm

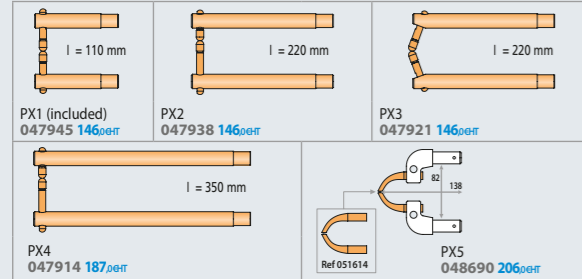

ELECTRODES



CAPS & ACCESSORIES

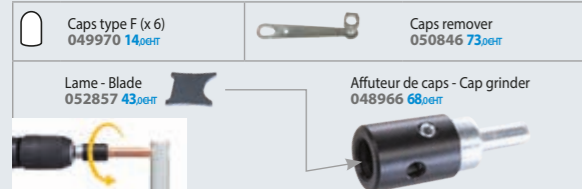

50/60 Hz	A	A	A	mm	V	m	mm ²	100% CU	(no arm) cm	kg
1 x 230V	16(D)	6 300	8 900	2+2	2,45	2,5	3x2,5 H05VVf	OK	36x29 x10	10

GYSPOT 32D-X
7 500 A 500 daN
 Air cooled
2 x 400V
 019881 **4 029,0 €HT**



GYSPOT 32D-C
7 500 A 300 daN
 Air cooled
2 x 400V
 019898 **4 029,0 €HT**



GYSPOT INVERTER 100R-X
10 000 A 500 daN
 For mild steel, HSS, UHSS
 Air cooled
Traceability software
 Save spot welding configuration and export data
3 x 400V
 019911 **5 691,0 €HT**



GYSPOT INVERTER 100R-C
10 000 A 300 daN
 For mild steel, HSS, UHSS
 Air cooled
Traceability software
 Save spot welding configuration and export data
3 x 400V
 019928 **5 712,0 €HT**



GYSPOT INVERTER 100R-CX
10 000 A 500 daN (X) 300 daN (C)
 For mild steel, HSS, UHSS
 Air cooled
Traceability software
 Save spot welding configuration and export data
3 x 400V
 022317 **7 020,0 €HT**



OPTIONS



INCLUDED

	019881	019898	019911	019928	022317
32D-X	■	■	■	■	■
32D-C	■	■	■	■	■
100R-X	■	■	■	■	■
100R-C	■	■	■	■	■
100R-CX	■	■	■	■	■

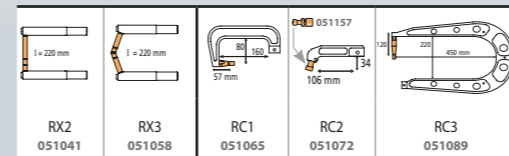
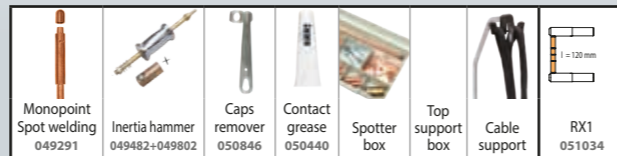

MADE IN FRANCE	50/60 Hz	A	A	A	mm	Uo	Cables		100% CU	cm	kg	
							Air Cooled	Ø mm ²				
GYSPOT 32D.X GYSPOT 32D.C	2 x 400V	32 (13 kVA) 40 (16 kVA)	7 500	10 500	3+3	1,2+3	11	2,2	200	OK	55 x 75 x 190	78
								2,5	150			
GYSPOT 100R.X GYSPOT 100R.C GYSPOT 100R.CX	3 x 400V	32 (22 kVA) 40 (28 kVA) 50 (35 kVA)	10 000	—	3+3+3	1,5+3	16	2,5	200	OK	70 x 99 x 208	107
								2,5	150			
								8	4 x 6 H07RNF			95.5

GYSPOT INVERTER AIR COOLED

GYSPOT INVERTER
BP-LX

13 000 A
550 daN

For mild steel, HSS, UHSS | Boron steel

Double pressure
∅ 10 mm
6,5 kg (included X1)

Liquid cooled

BP BODYPROTECT
Unique electro-magnetic field protection by GYS

Traceability software
Save spot welding configuration and export data

SD CARD MEMORY

019652 7 772,0 €HT

	019652 772,0€HT	058804 9294,0€HT
400V		
Gyspot BP-LX		
Monopoint/Spot 049291		
Spotter box pro (p.10) 050075		
Inertia hammer 049482 + 049802		
X1 050501		
X4A (x2) + X4B + X4C + X2 020733		
Liquid cooling (10l) 052246		(x3)



OPTIONS

050068 94€HT

x10 (x20: 052239) x18 (x6: 049987)
x6 (x6: 049994) x18 (x6: 049970)

048935 62€HT

x40 (x6: 049987)

SD CARD 050914 62€HT

2 GB

Liquide de refroidissement
Cooling liquid
Kühlmittel
Enfriamento líquido
Refrigeración líquida

052246 72€HT



Housse de protection
- Protection cover
- Schutzhaube

050853 206€HT



GYSPOT INVERTER
BP-LC-s7

13 000 A
550 daN

For mild steel, HSS, UHSS | Boron steel

Double pressure
∅ 10 mm
6,5 kg (included C1)

Liquid cooled

BP BODYPROTECT
Unique electro-magnetic field protection by GYS

EDC Automatic C clamp
Energy Dynamic Control

Traceability software
Save spot welding configuration and export data

SD CARD MEMORY

020757 9 351,0 €HT

	020757 9351,0€HT	058798 11168,0€HT
400V		
Gyspot BP-LC-s7		
Monopoint/Spot 049291		
Spotter box pro (p.10) 050075		
Inertia hammer 049482 + 049802		
Contact grease 050440		
Caps remover 050846		
Arm panel		
C1 019140		
C2 + C3 + C4 019126		
C6 019775		
Liquid cooling (10l) 052246		(x3)



Included
Support haute stabilité
-High stability support
Compatible gyro

+

OPTION

10-14 kg
GYRO 360° for BP-LC
051737 328€HT

MADE IN FRANCE 62135	50/60 Hz	A D curve	RMS A	U ₀ V	mm 3+3+3 1,5+3	Cables		100% CU	cm	kg	
						Liquid / Air Cooled	↔ m				
GYSPOT BPLX	3 x 400V	32 (22 kVA) 40 (28 kVA) 50 (35 kVA)	13 000	16	3+3+3 1,5+3	Liquid	2,5	200	OK	65 x 80 x 205	150
GYSPOT BPLC-s7		Air				2,5	150				



GYSPOT INVERTER
BP-LCX-s7

13 000 A
550 daN

For mild steel, HSS, UHSS Boron steel

Double pressure
Ø 10 mm
6,5 kg (included X1 or C1)

Liquid cooled

BP BODYPROTECT
2013/35/UE Unique electro-magnetic field protection by GYS

EDC Automatic C clamp
Energy Dynamic Control

Traceability software
Save spot welding configuration and export data

020948 **11 905,0 €HT**



OPTIONS

GYRO 360° for BP-LCX
051737
328€HT
10-14 kg

Included
Support haute stabilité
+High stability support
Compatible gyro
+🔒

OPTIONS

050068 94€HT
x10 (x20: 052239) x18 (x6: 049987)
x6 (x6: 049994) x18 (x6: 049970)

048935 62€HT
x40 (x6: 049987)

SD CARD 050914 62€HT

Liquide de refroidissement
Cooling liquid
Kühlmittel
Enfriamiento liquido
Refrigeração líquida

Housse de protection
- Protection cover
- Schutzhaube
for BP & PTI

050853 206€HT

052246 72€HT

GYSPOT INVERTER
EVOLUTION PTI

14 500 A
550 daN

For mild steel, HSS, UHSS Boron steel

16 > 25 A
Double pressure
Ø 10 mm
9,9 kg (included C1)

TRANSFORMER INSIDE

Liquid cooled

EDC Automatic C clamp
Energy Dynamic Control

Traceability software
Save spot welding configuration and export data

020894 **9 102,0 €HT**

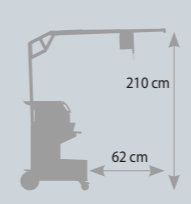

Very light
9,9 kg

10-14 kg
059696
162€HT



OPTION

Complete gun kit 067318

GYRO 360° for PTI 051720 164€HT

	020948 11 905,0€HT	220V

	4M 022188 10140,0€HT	4M 020894 9 102,0€HT	4M 067998
	6M 022195 10223,0€HT	6M 020900 9 185,0€HT	
	220V	400V	
			(x3)

MADE IN FRANCE 62135	50/60 Hz	A D curve	RMS A	U _o V	mm	Cables			100% CU	cm	kg		
						↔	↔	↔					
GYSPOT BP-LCX-s7 220 V	3x	200	60 (21-25 kVA)	10 500	15	3 + 3 + 3	1,5 + 3	2,5 m, Ø 200 mm ² , liquid	2,5 m, Ø 150 mm ² , air	8 m, 4x6 H07RNF (BP 220V: 4x6AWG)	OK	65 x 80 x 205	170
		208	80 (28-33 kVA)	11 000	17			4 m, liquid	8 m, 4x4 H07RNF				
		220	100 (35-41 kVA)	12 000	18			6 m, liquid	OPTION 067318: 1,6 m, Ø 200 mm ²				
GYSPOT EVOLUTION PTI-s7	3x 400 V	16 (11 kVA)	16 (11 kVA)	11 500	8	3 + 3 + 3	1,5 + 3	4 m, liquid	8 m, 4x4 H07RNF	OK	65 x 80 x 230	91	
		20 (14 kVA)	20 (14 kVA)	14 500	7,2			4 m, liquid	8 m, 4xAWG8 (SOOW)				
		220	25 (17 kVA)	14 500	8			6 m, liquid					
GYSPOT EVOLUTION PTI-s7 220 V	3x	200	30 (10-12 kVA)	12 500	6,95	3 + 3 + 3	1,5 + 3	4 m, liquid	8 m, 4xAWG8 (SOOW)	OK	65 x 80 x 230	91	
		208	40 (14-16 kVA)	13 000	7,2			4 m, liquid					
		240	50 (17-21 kVA)	14 500	8,3			6 m, liquid					

FOR GYSPOT 32D-X, 100R-X, BP-LX, BP-LCX**550 daN****6,5 kg** including X1

- DOUBLE PRESSURE
- LIQUID COOLED REFRIGERATION LIQUIDE
- Ø 10 mm

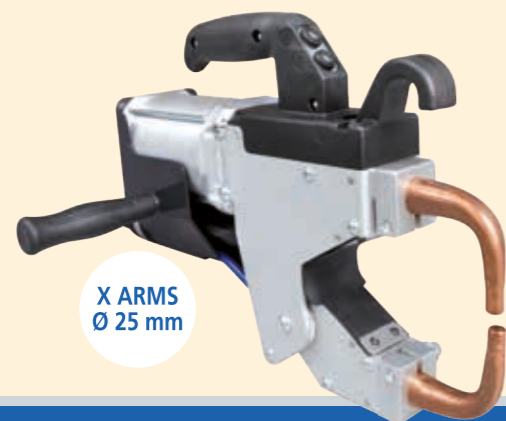
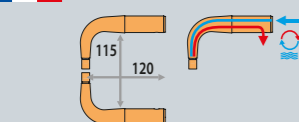
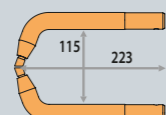
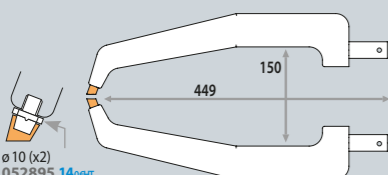
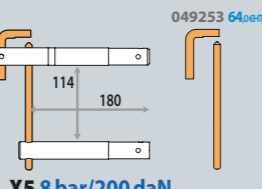
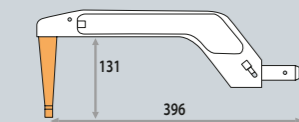
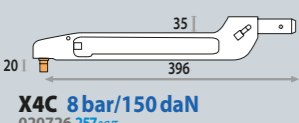
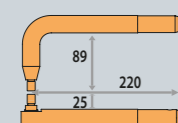
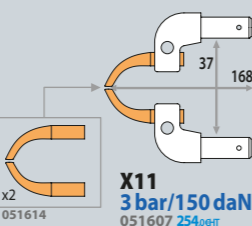
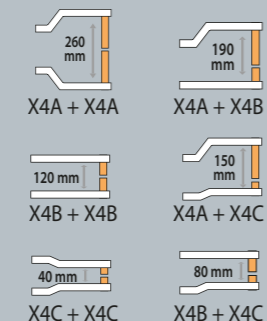

MADE IN FRANCE

**X ARMS**
Ø 25 mm**X Arms - Caps Ø13 mm****X1 8 bar/550 daN**
050501 259_{per}**X2 8 bar/400 daN**
050518 310_{per}**X4 8 bar/120 daN**
050532 371_{per}**X5 8 bar/200 daN**
050549 173_{per}**X4A 8 bar/150 daN**
020702 320_{per}**X4B 8 bar/150 daN**
020719 272_{per}**X4C 8 bar/150 daN**
020726 257_{per}**X6 8 bar/400 daN**
050587 394_{per}**X4 (A, B & C) combinations****X11 3 bar/150 daN**
051607 254_{per}**X ARMS PANELS****X4A (x2) + X5 + X2**
022324 1143_{per}X arms support
021471 32_{per}**X4A (x2) + X4B + X4C + X2**
020733 1440_{per}X arms support
021471 32_{per}**Remote control (BP)**Digital screen control
Change Mode & Parameters

X clamp control



C clamp control

**C ARMS****FOR GYSPOT BP-LCX, BP-LC****550 daN****6,5 kg** including C1

- DOUBLE PRESSURE
- LIQUID COOLED REFRIGERATION LIQUIDE
- Ø 10 mm

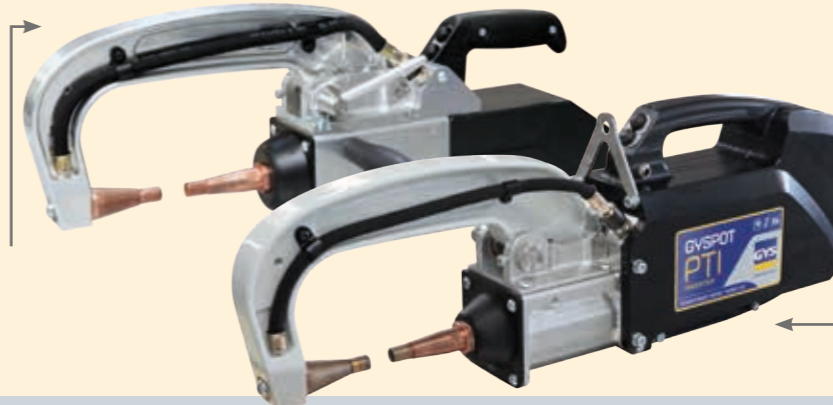

MADE IN FRANCE

**550 daN****Transformer inside****9,9 kg** including C1

- DOUBLE PRESSURE
- AIR COOLED + LIQUID COOLED
DOUBLE REFRIGERATION
AIR + LIQUID
- Ø 10 mm

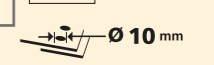
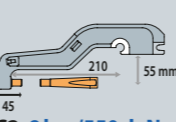
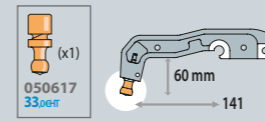
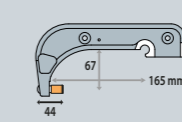
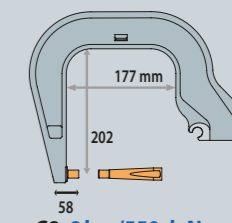
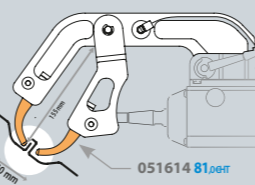
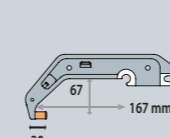
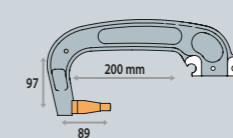
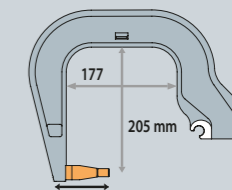
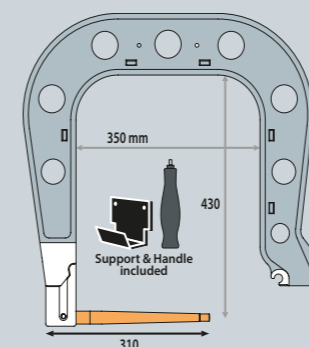
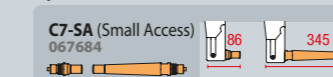
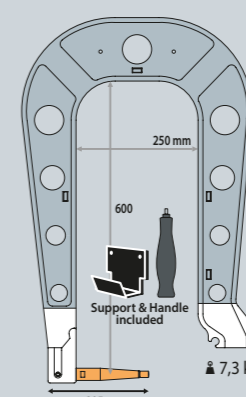
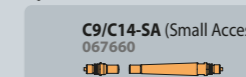
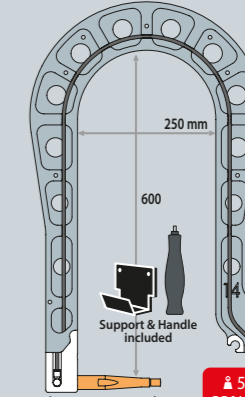
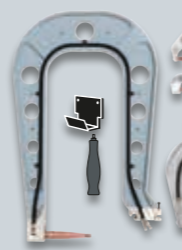
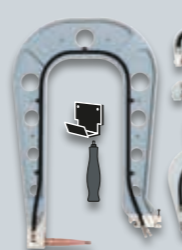
**Arm lock pin****C Arms - Caps Ø13 mm****Classic arms****CLASSIC FINISH****Bras isolés - Isolated arms - Isolierte Bügel****ELECTRICAL INSULATION****C2 8 bar/550 daN**
022386 485_{per}
019133 401_{per}**C6 8 bar/300 daN**
022409 312_{per}
019775 267_{per}**C12 8 bar/550 daN**
022997 340_{per}**C8 8 bar/550 daN**
021440 577_{per}
020016 470_{per}**C10 4 bar/150 daN**
051638 571_{per}**C5 8 bar/550 daN**
022393 287_{per}
019294 262_{per}**C1 8 bar/550 daN**
021402 450_{per}
019140 371_{per}**C3 8 bar/550 daN**
021419 554_{per}
019157 462_{per}**X Arms - Caps Ø13 mm****C11 8 bar/550 daN**
053649 686_{per}**C7 8 bar/550 daN**
021433 1247_{per}
020009 1143_{per}**Option for C7****C7-SA (Small Access)**
067684**C9 8 bar/550 daN**
020078 1303_{per}**Option for C9 & C14****C9/C14-SA (Small Access)**
067660**C14 8 bar/400 daN**
023543 1326_{per}**▲ 5,7 kg**
22% saved**C ARMS PANELS**C2
+ C3
+ C4
019126 1498_{per}C2
+ C3
+ C4
021457 1691_{per}C2
+ C3
+ C4
060821 1727_{per}C2 + C3 + C5 + C6 = 051553 1371_{per}
C2 + C3 + C5 + C6 + C9 = 050044 2674_{per}C2 + C3 + C6 + C12 = 061286 1567_{per}
C2 + C3 + C6 + C12 + C9 = 061316 2870_{per}

SPOT WELDING

GENIUS

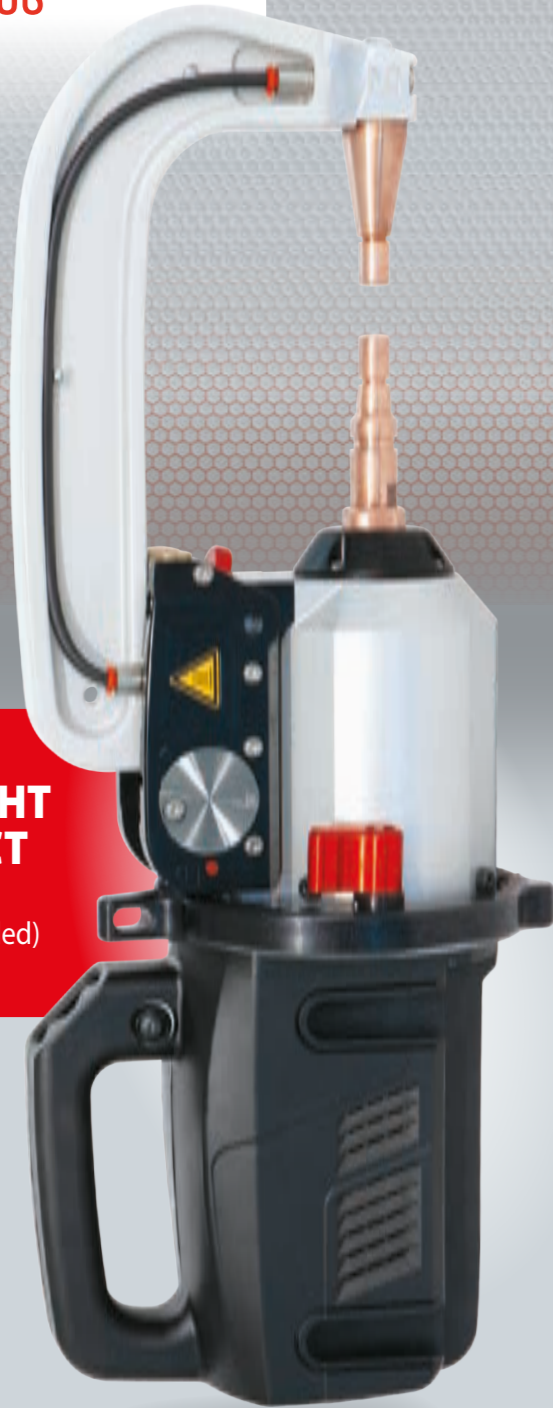

MADE IN FRANCE

ULTRA LIGHT & COMPACT

6.5 kg
(Gyro & G1 included)

550 daN

LIQUID COOLED
REFROIDISSEMENT LIQUIDE
Ø 10 mm

6.5 kg
(Gyro & G1 included)

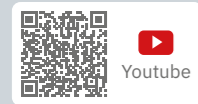

OPTIONS



Liquide de refroidissement
Cooling liquid
Kühlmittel
Enfriamento líquido
Refrigeración líquida
052246 722eHT



Housse de protection
- Protection cover
- Schutzhaube
for BP & PT1
050853 206eHT



10-14 kg
059696 162eHT

FAST OPEN XL

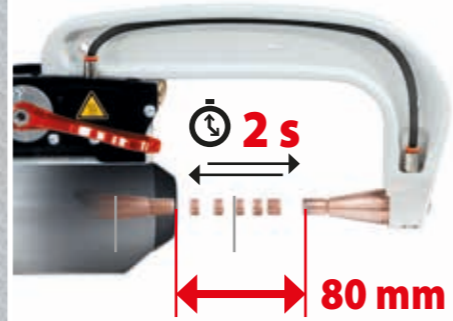

EASY



GYRO INTEGRATED

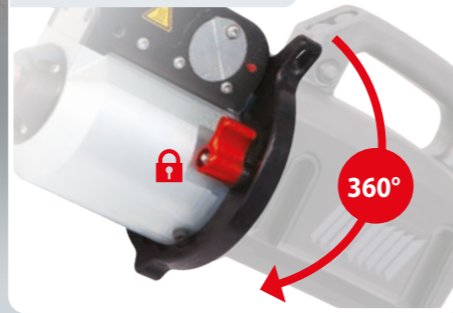

PERFECT ELECTRICAL CONNECTION



AUTO



GYSPOT INVERTER BP-LG

13 000 A
550 daN

For mild steel, HSS, UHSS Boron steel

BP BODYPROTECT
Unique electro-magnetic field protection by GYS

Traceability software
Save spot welding configuration and export data

023451 11 430,0eHT

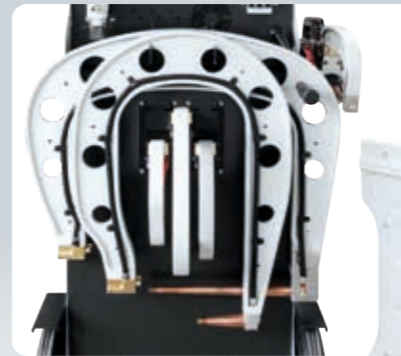

Included Protection 067271

120 cm

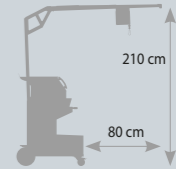

Included Cable support for BPLG ULTRA RESISTANT 059719 465eHT

Gun & cable support

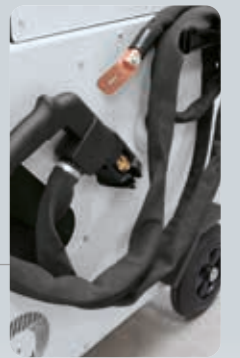

	023550 12 572eHT	023451 11 430eHT	023499 13 399eHT
Gyspot BP-LG	220V	400V	
Monopoint/Spot 049291	▪	▪	▪
Spotter box pro (p.10) 050075	▪	▪	▪
Inertia hammer 049482 + 049802	▪	▪	▪
Caps remover 050846	▪	▪	▪
Arm support	▪	▪	▪
G1 022768	▪	▪	▪
G2 + G3 + G4 022898	▪	▪	▪
Liquid cooling (10l) 052246			(x3)

MADE IN FRANCE 62135	50/60 Hz	+AM+ A D curve	RMS A	Uo V	mm 3+3+3 1,5+3	Cables			100% CU	cm	kg
						2,5 m, Ø 200 mm ² , Liquid	2,5 m, Ø 150 mm ² air	8 m 4x16 mm ² (6AWG) 500W			
GYSPOT B.P.LG 220 V	3 x	60 (21-25 kVA) 80 (28-33 kVA) 100 (35-41 kVA)	10 500 11 000 12 000 12 500	15 15,5 17 18	3+3+3 1,5+3	2,5 m, Ø 200 mm ² , Liquid	2,5 m, Ø 150 mm ² air	8 m 4x16 mm ² (6AWG) 500W	OK	65 x 80 x 205	160
GYSPOT B.P.LG 400V	3 x 400V	32 (22 kVA) 40 (28 kVA) 50 (35 kVA)	13 000	16	3+3+3 1,5+3	2,5 m, Ø 200 mm ² , Liquid	2,5 m, Ø 150 mm ² air	8 m 4x6 mm ² H07BNF	OK	65 x 80 x 205	160

FAST OPEN XL

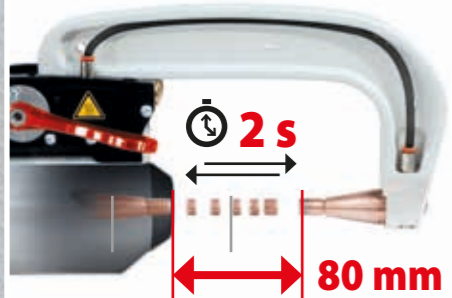

GYRO INTEGRATED



PERFECT ELECTRICAL CONNECTION

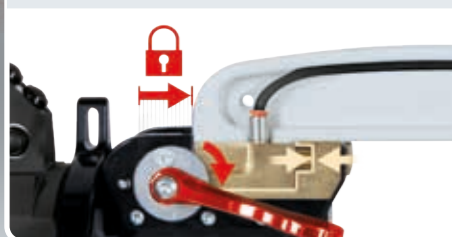

AUTO



NEW



MADE IN FRANCE



TRANSFORMER INSIDE

550 daN

LIQUID COOLED
REFROIDISSEMENT LIQUIDE

Ø 10 mm

11.3 kg
(Gyro & G1 included)

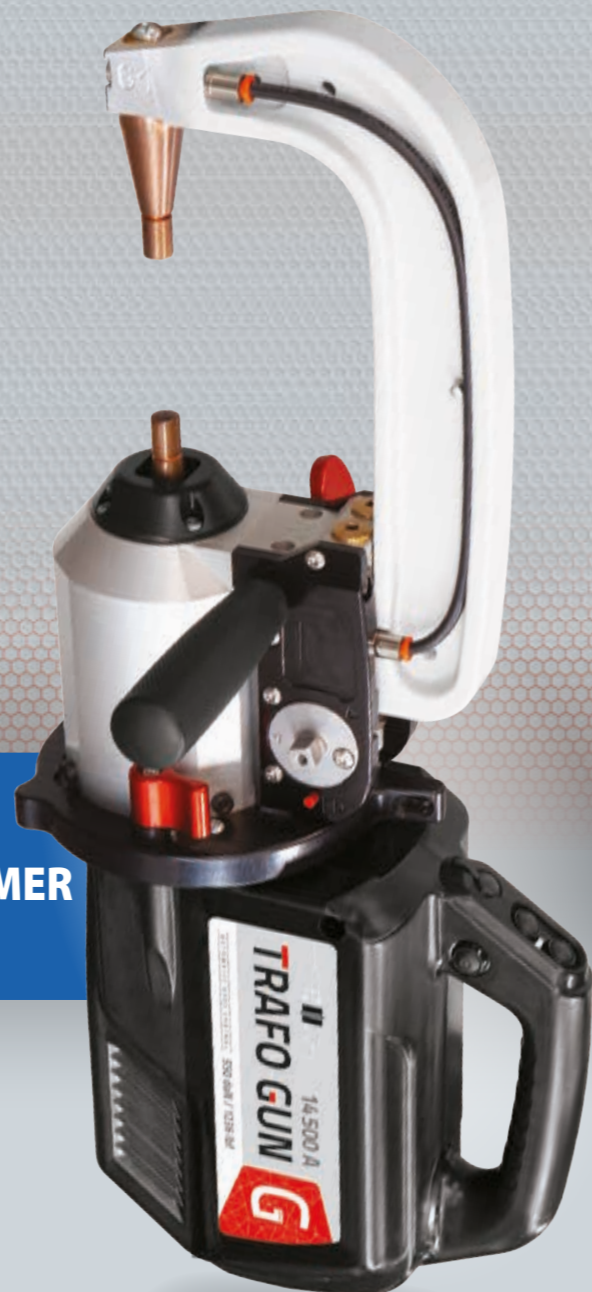

**Potence électrique - Motorised cable support
- Elektrisch verstellbarer Kabelsupport**



Ergonomic

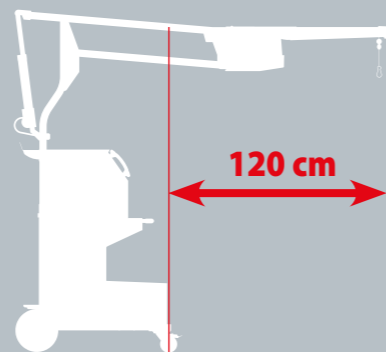

OPTIONS

<p>x40 (x6: 049987) 048935 620ert</p>	<p>SD CARD 050914 620ert</p>	<p>Liquide de refroidissement - Cooling liquid - Kühlmittel - Enfriamento líquido - Refrigeração líquida</p> <p>052246 722ert</p>	<p>Housse de protection - Protection cover - Schutzhaube for BP & PTI</p> <p>050853 2060ert</p>
-----------------------------------------------	--------------------------------------	-----------------------------------------------------------------------------------------------------------------------------------	-----------------------------------------------------------------------------------------------------

**GYSPOT INVERTER
PTI-G**

14 500 A
550 daN

For mild steel, HSS, UHSS **Boron steel**

TRANSFORMER INSIDE

Traceability software
Save spot welding configuration and export data



	024854	024878	068001	024892
Gyspot BP-LG	220V	400V	480V	
Monopoint/Spot 049291	▪	▪	▪	▪
Spotter box pro (p.10) 050075	▪	▪	▪	▪
Inertia hammer 049482 + 049802	▪	▪	▪	▪
Caps remover 050846	▪	▪	▪	▪
Arm support	▪	▪	▪	▪
G1 022768	▪	▪	▪	▪
G2 + G3 + G4 022898	▪	▪	▪	▪
Kit gun 067226	▪	▪	▪	▪
Liquid cooling (10l) 052246			(x3)	

Included
Cable support
ULTRA RESISTANT



ELECTRIC MOTOR

NEW

Control
Commande

**Grande stabilité
- High stability**

OPTIONS

Kit gun PTI-G
067226



MADE IN FRANCE 62135	50/60 Hz	-AM- A D curve	RMS A	Uo V	mm		Cables		cm	kg	
					↕	↔	↕	↔			
GYSPOT PTI.G 220 V	3 x	200 208 220 240	12 500 13 000 14 500 14 500	6.6 6.9 7.3 7.9	3 + 3 + 3	1,5 + 3	6 m, Liquid	8 m 4xAWG8 (500W)	71 x 90 x 200	100	
GYSPOT PTI.G 400V	3 x	400V	25 (17 kVA)	14 500	7	3 + 3 + 3	1,5 + 3	6 m, Liquid	8 m 4x4 mm ² H07RNF	71 x 90 x 200	100
GYSPOT PTI.G 480V	3 x	480V	20 (17 kVA)	14 500	7	3 + 3 + 3	1,5 + 3	6 m, Liquid	8 m 4xAWG12 (500W)	71 x 90 x 200	100

FOR GYSPOT BP-LG & PTI-G

G Arms - Caps Ø13 mm

Bras isolés - Isolated arms - Isolierte Bügel

NEW Reversible
for G1, G3, G4,
G5, G8 & G10

Kit de maintenance
connecteurs pince G -
Connectors maintenance
kit for G clamp
067295

050617 (x1)
33,00€

G2
8 bar/300 daN
022775 432,00€

051614 (x1)
81,00€

G6
8 bar/550 daN
022812 439,00€

G7
4 bar/150 daN
022829 607,00€

G1
8 bar/550 daN
022768 518,00€

G3
8 bar/550 daN
022782 610,00€

Option for G1 & G3
G1/G3-SA (Small Access)
067653 (for arms > 02/2021)

G4
8 bar/550 daN
022799 950,00€

Option for G4
G4-SA (Small Access)
064478 71,00€ (for arms < Oct 2019)

G5
8 bar/550 daN
022805 1 349,00€

Option for G5
G5-SA (Small Access)
067660 (for arms < Oct 2019)

G8
8 bar/550 daN
022836 1 394,00€

Option for G8
G8-SA (Small Access)
067677 (for arms < Oct 2019)

NEW

G10
8 bar/400 daN
067165

5 kg
20% saved

X1 (Included with G9)
050501 259,00€

G9
8 bar/550 daN
022881 1 247,00€

G9 + Clamp extension
for G-Clamp S/N < Oct. 2019
063419 1 280,00€

Option Compatible X2
050518 310,00€

Option Compatible X6
050587 394,00€

Option SD card
050914 62,00€

Option PCB
97449C

G > X
UNIQUE SYSTEM
by GYS

AUTOMATIC WELDING
FOR X1, X2 & X6

BREVETÉ PATENTÉ

Youtube

CONSUMMABLES X & C - X & C Consumables

Type A Cor X clamp Ø 13 mm (x6) 049987 12,00€	Type D Cor X clamp Ø 13 mm (x10) 058507 46,00€	TYPE G Ø 13 mm (x10) 059672 34,00€	048935 62,00€	050068 94,00€
Type B Cor X clamp Ø 13 mm / Ø 5 mm (x6) 055506 16,00€	TYPE F For single sided gun Ø 13 mm (x6) 049970 14,00€	Caps inclinés - Beveled X2, X4, C11 arms Ø 13 mm (x6) 049994 21,00€	x40 (x6: 049987)	x10 (x20: 052239) x6 (x6: 049994)

Graisse contact Contact grease 050440 16,00€	Caps remover 050846 73,00€	Europax anti-corrosion 052758 100,00€	Monopoint/Spot 049291 21,00€
----------------------------------------------------	----------------------------------	------------------------------------------------	---------------------------------

AFFUTEUR DE CAPS PNEUMATIQUE - Pneumatic cap grinder

061484 3 657,00€

Lame - Blade
061491 571,00€

Type A caps

AFFUTEUR DE CAPS - Cap grinder

Lame - Blade
052857 43,00€

048966 68,00€

Optimal speed:
400-800 rpm

Youtube

BANC DE TRACTION ARRACHE TÔLE - Steel sheet traction bench - Blech-Zugbank zur Festigkeitsprüfung

052420 2 217,00€

052321 (included)

VALISE TEST SOUDURE HLE / THLE - Weld test kit - Schweißtestkit im Hartschalenkoffer

050433
457,00€

Barre d'arrachage / Traction bar
+ Acier doux / Mild steel 0.65 (x25) + 1.0 (x25)
+ Acier HSLA 360 - HLE 0.8 (x25) + 1.5 (x25)
+ Acier DP600 - THLE/UHLE 1.0 (x25)
+ Acier FB560 - THLE/UHLE 2.5 (x25)

PROTECTION ANTI-ARC 12 V - Anti-arc protection 12V - Lichtbogenschutz 12V - Protección anti-arco 12V

041318 18,00€

GYRO 360°

for BPLC/BPLCX
051737 328,00€

10-14 kg

for EVOLUTION
051720 164,00€

ÉCHANTILLONS DE TÔLES - Sheets set

Acier standard / Standard steel
0.8 (x65) + 1 (x55) + 1.5 (x35) + 2 (x25)
+ Alu
1 (x45) + 1.5 (x30) + 2 (x20)

055841 136,00€

CAPTEUR D'EFFORT - Electrode force sensor

052314 192,00€

KIT DE PURGE RÉSERVOIR - Tank draining kit - Kit zur Tankentleerung

058286 24,00€

for GYSPOT
BP & PTI

CARTE MÉMOIRE SD - SD memory card

SD CARD
050914
62,00€

2 GB

HOUSSE DE PROTECTION - Protection cover - Schutzhaube

for BP & PTI
050853
206,00€

LIQUIDE DE REFROIDISSEMENT - Cooling liquid - Kühlmittel - Enfriamento líquido - Refrigeração líquida

052246
72,00€



RIVETING

PNEUMATIC HYDRAULIC



OPTIONS



Support Riveteuse pour changements d'accessoires (bras & matrice)
- Riveting machine support for changing accessories (arms & dies)
- Supportständer

↳ 28 x 40 x 21,5 cm

054158 160,0 €HT



Chariot-Trolley
↳ 51 x 82 x 74 cm

054233 503,0 €HT



Chariot+Support-Trolley+Support
↳ 51 x 122 x 74 cm

055391 663,0 €HT

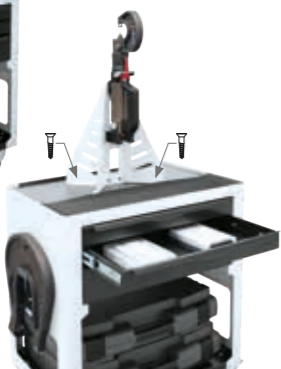

Capteur d'effort
for GYSPRESS 10T, 8T & 10T PushPull, 10T PP CONTROL
062115 480,0 €HT



Hydraulic body wrenches
for GYSPRESS 10T, 10T PushPull, 10T PP CONTROL (x 2)
067325 192,0 €HT



POWER 10t



Levier de décharge
- Discharge lever
- Auslösehebel



Contrôle de la vitesse
- Speed control
- Regelung Werkzeuggeschwindigkeit



Contrôle de la pression
- Pressure control
- Druckregelung

GYSPRESS 10T

6.5 bar 100 kN

10t



HR110
063310



Strap-Sangle-Gurt



XT11.21 - Extension
for HR110 & HR210
058644



HR arm locker



Standard 8T/10T tool box
053694



Poignée-Handle-Griff



6 x 50 rivets RAP -
Nieten SPR
048706

063303 3 569,0 €HT

PUSH PULL SYSTEM by GYS



Sélection Push/Pull - Push/Pull selection



GYSPRESS 8T PUSH PULL

GYSPRESS 10T PUSH PULL



POWER 8t

UNIQUE PUSH PULL SYSTEM by GYS



Contrôle de la vitesse
- Speed control
- Regelung Werkzeuggeschwindigkeit



Contrôle de la pression
- Pressure control
- Druckregelung

GYSPRESS 8T PUSH PULL

8 bar 80 kN

8t



HR15
054219



Strap-Sangle-Gurt



XT11.21 - Extension
for HR110 & HR210
058644



HR arm locker



Standard 8T/10T PushPull
tool box
058361



Poignée-Handle-Griff



6 x 50 rivets RAP -
Nieten SPR
048706

056893 3 766,0 €HT

GYSPRESS 10T PUSH PULL

6.5 bar 100 kN

10t



HR110
063310



Strap-Sangle-Gurt



XT11.21 - Extension
for HR110 & HR210
058644



HR arm locker



Standard 8T/10T PushPull
tool box
058361



Poignée-Handle-Griff



6 x 50 rivets RAP -
Nieten SPR
048706

063853 4 554,0 €HT

MADE IN FRANCE	AIR BAR	PRESSURE CONTROL	SPEED CONTROL	↕	⚖	↕	⚖	
				cm	kg	cm	kg	
GYSPRESS 10T	6.5 bar = 10 t (maxi 10 bar)	0 > 6.5 bar	+ -	39.5 x 180	6.2 (HR110 included)	58 x 48 x 15	11.8	
GYSPRESS 8T PUSH PULL	8 bar = 8 t (maxi 10 bar)	0 > 8 bar	+ -	39.5 x 180	5.8 (HR15 included)	58 x 48 x 15	11.7	
GYSPRESS 10T PUSH PULL	6.5 bar = 10 t (maxi 10 bar)	0 > 6.5 bar	+ -	39.5 x 180	6.7 (HR110 included)	58 x 48 x 15	12.5	



GYPRESS

SYNERGIC RIVETING WORKSTATION

PNEUMATIC HYDRAULIC



UNIQUE 100%
No air inclusion
maintenance free, no oil refill

ACCESSIBILITY

10 languages

- FR ES CN
- GB CZ JP
- DE NL
- IT RU

★★★★★
SYNERGIC RIVETS SETTINGS

Main panel

Setup instructions



Results



3 MODES

- MANUAL
- SYNERGIC
- CAR MANUFACTURERS

CAR MANUFACTURERS COMPATIBILITY

- ✓ VW GROUP
- ✓ MERCEDES-BENZ
- ✓ BMW
- ✓ TESLA
- ✓ FERRARI
- ✓ FORD
- ✓ JAGUAR / LAND ROVER

CONNECTIVITY

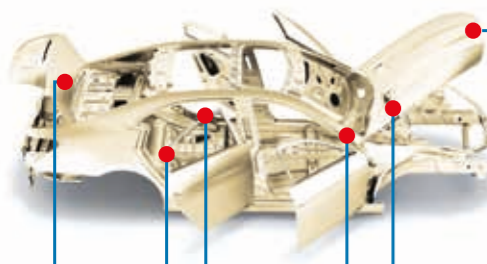

TRACEABILITY

History data export

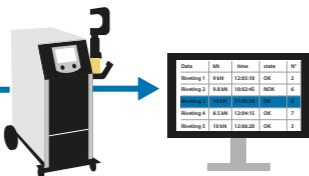

SOFTWARE UPDATE

Gyspress evolutions

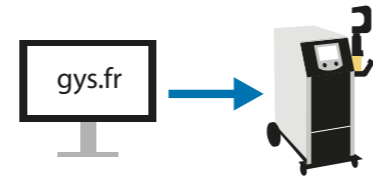

UNIQUE PUSH PULL SYSTEM by GYS

PUSH PULL SYSTEM by GYS

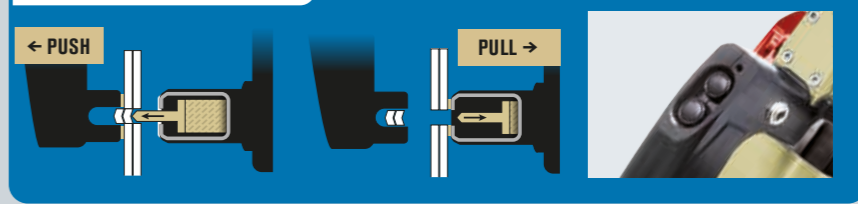

NEW 02 2021

REGULATED PRESSURE CONTROL

POWER 10t



Levier de décharge - Discharge lever - Auslösehebel



WORKSTATION GYPRESS 10T PP CONTROL

6.5 bar | 100 kN
10 t

063860

included



OPTIONS

Capteur d'effort
for GYPRESS 10T, 8T & 10T PushPull, 10T PP CONTROL 062115 480eur



Youtube

Hydraulic body wrenches for GYPRESS 10T, 10T PushPull, 10T PP CONTROL (x2) 067325 192eur

MADE IN FRANCE WORKSTATION GYPRESS 10T PP CONTROL	230 V	AIR BAR 6.5 bar = 10 t (maxi 10 bar)	PRESSURE CONTROL 0 > 6.5 bar	SPEED CONTROL + -	cm	kg
					N/A	N/A (HR110 included)

GYPRESS CONTROL

SYNERGIC RIVETING



BRAS DE RIVETAGE - Riveting arms - Stanznietbügel



Compatibility

	HR110 063310 434 _{DEHT}	HR210 063327 561 _{DEHT}	HR310 8t 065963 1029 _{DEHT}	HR310 10t 063334 1029 _{DEHT}
GYSPRESS 8T	✓	✓	✓	—
GYSPRESS 10T	✓	✓	—	✓
GYSPRESS 8T PUSH PULL	✓	✓	—	✓
GYSPRESS 10T PUSH PULL	✓	✓	—	✓
GYSPRESS 10T CONNECT	✓	✓	—	✓

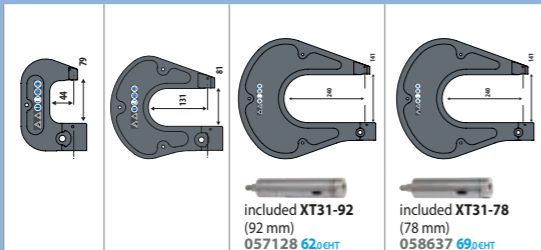

included XT31-92 (92 mm) 057128 62_{DEHT}

included XT31-78 (78 mm) 058637 69_{DEHT}



KIT HR210 + HR310 8t
065970
1 818,0 €_{HT}

KIT HR210 + HR310 10t
064089
1 818,0 €_{HT}

XT31-40
Rallonges bras HR310 pour point milieu - HR310 arm extension for middle point
x2
066335 103_{DEHT}

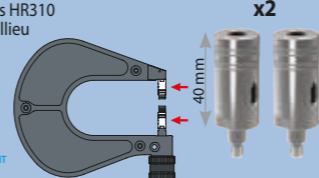

RIVETS AUTOPERÇANTS (RAP) - Self piercing rivets (SPR) - Stanznieten

Steel - Acier - Stahl	Complete box 048706 63 _{DEHT}							
	Ø 3,3 x 3,5 mm x 50	Ø 3,3 x 4 mm x 50	Ø 5,3 x 4 mm x 50	Ø 5,3 x 5 mm x 50	Ø 5,3 x 6 mm x 50	Ø 5,3 x 8 mm x 50	Ø 5,3 x 7 mm	Ø 5,3 x 9 mm
	x 200 048232 26 _{DEHT}	x 200 048249 29 _{DEHT}	x 100 048256 19 _{DEHT}	x 100 048263 19 _{DEHT}	x 100 048270 19 _{DEHT}	x 100 048225 19 _{DEHT}	x 100 048638 19 _{DEHT}	x 100 048645 25 _{DEHT}

POINTEAU CENTREUR - Special center punch - Spezialkörner



MATRICES - Dies - Matrizen

Pose de rivets auto-perçants
- Application of self-piercing rivets
- Stanzniet-Verpressen

2.0 < 6.5 mm 3 < 5.8 bar

Pose de rivets pleins
- Application of solid rivets
- Vollniet-Verpressen

2.3 < 8.3 mm 5.3 < 8 bar

Pose de rivets Flow-Form
- Application of Flow-form rivets
- Setzen v. Fließformnieten

2.3 < 8.3 mm

Extraction de rivets
- Extraction of rivets
- Niet-Auspressen

2.3 < 8.3 mm 8 bar

Percage et formage des tôles pour rivets pleins
- Metal sheet punching and shaping
- Vollniet-Lochstanzen/Prägen

2.3 < 8.3 mm 8 bar

KN	Ø 3.3	Ø 5.3	RFF Alu Ø 6	RFF Steel Ø 6	RFF Steel Ø 8	Eject & Drilling
30	3-5.2 bar	4.7-5.8 bar	5.3-6.4 bar	5.8-7 bar	6.5-8 bar	8 bar

A1 x1 055698 55 _{DEHT}	G2 x1 057180 34 _{DEHT}	H7 x1 068292	F3 x1 055797 27 _{DEHT}	E2 x1 055766 32 _{DEHT}	E12 x1 058828 37 _{DEHT}	D15 x1 056077 23 _{DEHT}	T5 x1 058019 75 _{DEHT}
A2 x1 055704 33 _{DEHT}	G3 x1 057197 25 _{DEHT}	H8 x1 068308	F4 x1 055803 27 _{DEHT}	E1+E2 x1 054318 57 _{DEHT}	E13 x1 059085 30 _{DEHT}	D16 x1 056084 27 _{DEHT}	T7 x1 058033 32 _{DEHT}
A1+A2 x1 054295 74 _{DEHT}	G4 x1 057203 25 _{DEHT}	S3 x1 057043 27 _{DEHT}	F5 x1 055810 27 _{DEHT}	E3 x1 057005 48 _{DEHT}	S1 x1 057036 27 _{DEHT}	ST1 x1 058071 62 _{DEHT}	T8 x1 058040 71 _{DEHT}
B1 x1 055711 51 _{DEHT}	G5 x1 057210 25 _{DEHT}	S7 x1 057074 27 _{DEHT}	D1 x1 055971 27 _{DEHT}	E4 x1 057012 27 _{DEHT}	S4 x1 057050 27 _{DEHT}	ST2 x1 058088 64 _{DEHT}	T10 x1 058064 30 _{DEHT}
B2 x1 055728 35 _{DEHT}	G6 x1 057227 27 _{DEHT}	S8 x1 057081 29 _{DEHT}	D2 x1 055988 27 _{DEHT}	E5 x1 057029 27 _{DEHT}	S5 x1 057067 27 _{DEHT}	ST3 x1 066397 57 _{DEHT}	T12 x1 066373 43 _{DEHT}
B1+B2 x1 054301 75 _{DEHT}	H1 x1 068230	D8 x1 056039 25 _{DEHT}	D3 x1 055995 25 _{DEHT}	E6 x1 057142 27 _{DEHT}	D5 x1 056008 27 _{DEHT}	T1 x1 057098 27 _{DEHT}	T13 x1 066380 32 _{DEHT}
B3 x1 055735 51 _{DEHT}	H2 x1 068247	D9 x1 056046 25 _{DEHT}	D4 x1 055742 24 _{DEHT}	E7 x1 057159 37 _{DEHT}	D6 x1 056015 25 _{DEHT}	x5 059078 119 _{DEHT}	T14 x1 066410 27 _{DEHT}
B4 x1 059016 39 _{DEHT}	H3 x1 068254	D17 x1 055681 23 _{DEHT}	D13 x1 055759 23 _{DEHT}	E8 x1 057166 34 _{DEHT}	D7 x1 056022 32 _{DEHT}	T2 x1 057104 25 _{DEHT}	T15 x1 066427 23 _{DEHT}
B5 x1 059023 37 _{DEHT}	H4 x1 068261	F1 x1 055681 23 _{DEHT}	D17 x1 055681 23 _{DEHT}	E9 x1 058606 48 _{DEHT}	D10 x1 055674 25 _{DEHT}	T1+T2 x1 054707 55 _{DEHT}	T16 x1 066434 30 _{DEHT}
B6 x1 059030 37 _{DEHT}	H5 x1 068278	F2 x1 055780 30 _{DEHT}	D13 x1 055681 23 _{DEHT}	E10 x1 058613 27 _{DEHT}	D11 x1 056060 71 _{DEHT}	T3 x1 055827 27 _{DEHT}	
B7 x1 057173 30 _{DEHT}	H6 x1 068285	F1+F2 x1 054714 55 _{DEHT}	E1 x1 055865 30 _{DEHT}	E11 x1 058620 27 _{DEHT}	D12 x1 056053 23 _{DEHT}	T4 x1 055834 27 _{DEHT}	

BOÎTES MATRICES STANDARDS - Dies boxes - Standard-Matrizensätze

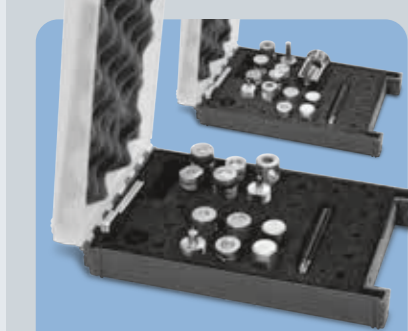

STANDARD 8T/10T Included in GYSPRESS 10T 053694 389_{DEHT}

x1	x1	x1	x1	x1	x1	x2	x1	x1	x1	x1	x2	x4	x1
A1	A2	B1	B2	F1	F2	D17	E1	E2	T1	T2	clé	key	joints
Ø 3.2 > 3.5	Ø 3.3	Ø 5 > 5.3	Ø 5.3	Ø 6 - A1/2/3, 50/1/2/3/4/5/6	—	Ø 3.3 > 4.8	Ø 3.9 > 5.3	Ø 6					

STANDARD 8T/10T PUSH PULL Included in GYSPRESS 8T Push Pull & 10T Push Pull 058361 546_{DEHT}

x1	x1	x1	x1	x1	x1	x2	x1	x1	x1	x1	x2	x4	x1
A1	A2	B1	B2	F1	F2	D17	E1	E2	ST1	T5	T7	clé	key
Ø 3.2 > 3.5	Ø 3.3	Ø 5 > 5.3	Ø 5.3	Ø 6 - A1/2/3, 50/1/2/3/4/5/6	—	Ø 3.3 > 4.8	Ø 3.9 > 5.3	Ø 6					

Included XT31-60 - 60 mm extension for HR3 (use with ST1, T5, T7) 057135



KIT RMB PP05

Low pressure
Idéal aluminium, aciers doux - Ideal for aluminium, mild steel 066366 121_{DEHT}



KIT RMB 08 PREMIUM

HIGH pressure
Idéal aciers durs, Boron - Ideal for UHS, Boron 066403 71_{DEHT}

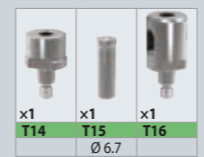

Compatibility

GYSPRESS 8T	STANDARD 8T/10T	—
GYSPRESS 10T	—	KIT RMB 08 PREMIUM
GYSPRESS 8T PUSH PULL	—	KIT RMB PP05
GYSPRESS 10T PUSH PULL	STANDARD 8T/10T PUSH PULL	KIT RMB PP05 & KIT RMB 08 PREMIUM
GYSPRESS 10T CONNECT	—	—

BOÎTES MATRICES CONSTRUCTEURS - Car manufacturers boxes - OEM-Matrizensätze



Compatibility

	BMW	Jaguar Land Rover	VW Group	Mercedes-Benz	Ford	Ferrari	Tesla
GYSPRESS 8T	RMB 01	RMB 02	RMB 03	RMB 04	RMB 05	RMB 06	—
GYSPRESS 10T	RMB 01	RMB 02	RMB 03	RMB 07	RMB PP02	RMB 06	RMB 09 & RMB PP03
GYSPRESS 8T PUSH PULL	RMB 01	RMB 02	RMB 03	RMB PP01	RMB PP02	RMB 06	RMB 09 & RMB PP03
GYSPRESS 10T PUSH PULL	RMB 01	RMB 02	RMB 03	RMB PP01	RMB PP02	RMB 06	RMB 09 & RMB PP03
GYSPRESS 10T CONNECT	RMB 01	RMB 02	RMB 03	RMB PP01	RMB PP02	RMB 06	RMB 09 & RMB PP03

RMB 01 - BMW

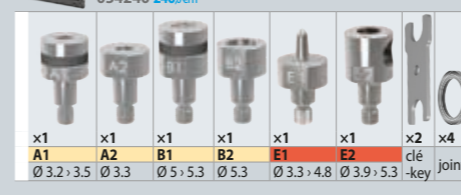

RMB 02 - Jaguar / Land Rover

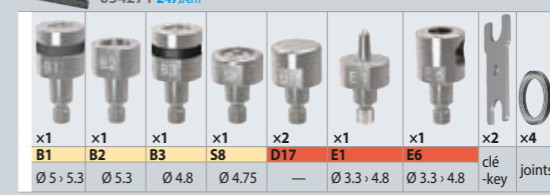

RMB 03 - VW Group

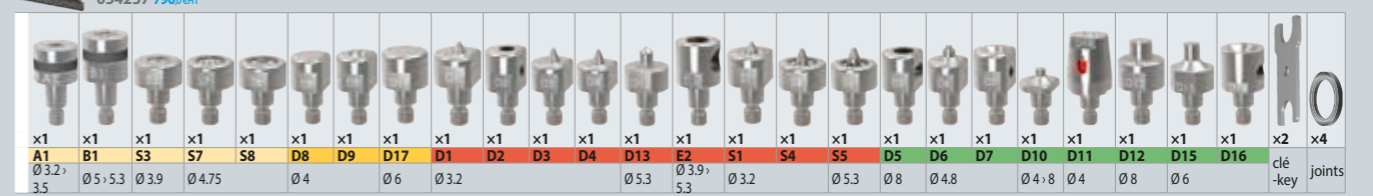

RMB 04 - Mercedes-Benz

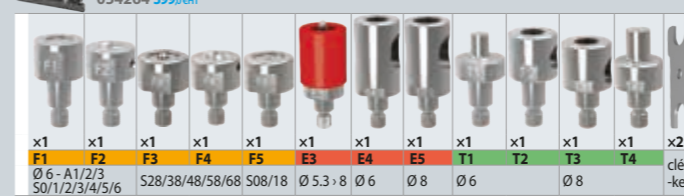

RMB 05 - Ford

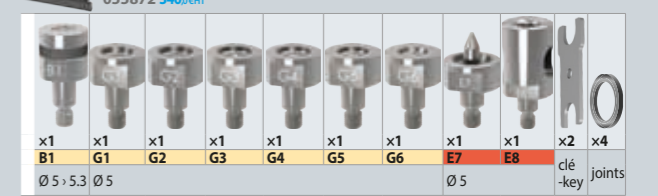

RMB 06 - Ferrari

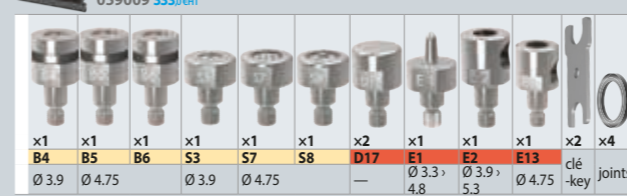

RMB 07 - Mercedes-Benz

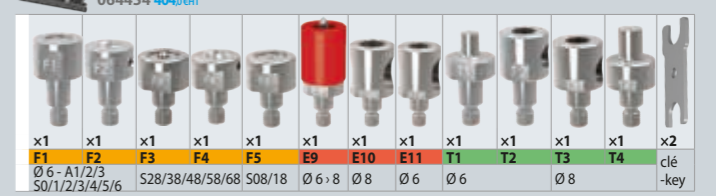

RMB 09 - Tesla

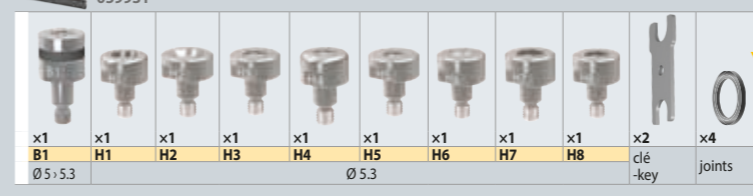

RMB PP01 - Mercedes-Benz

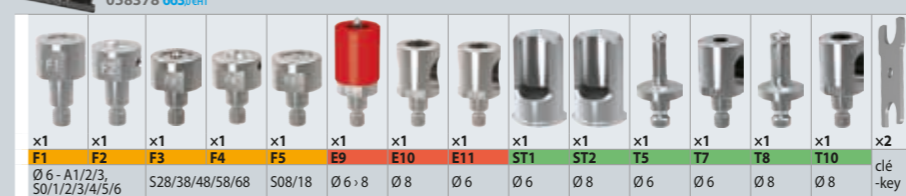

RMB PP02 - Ford

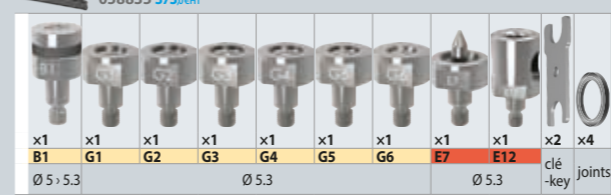

RMB PP03 - Tesla

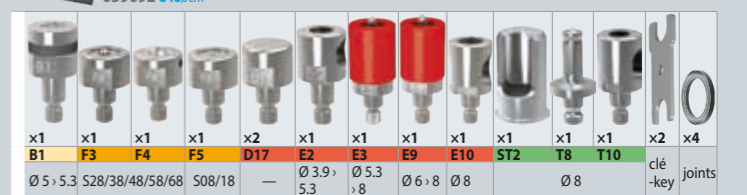



ADAPTATEURS POUR RIVETS AVEUGLES - BLIND RIVET ADAPTERS

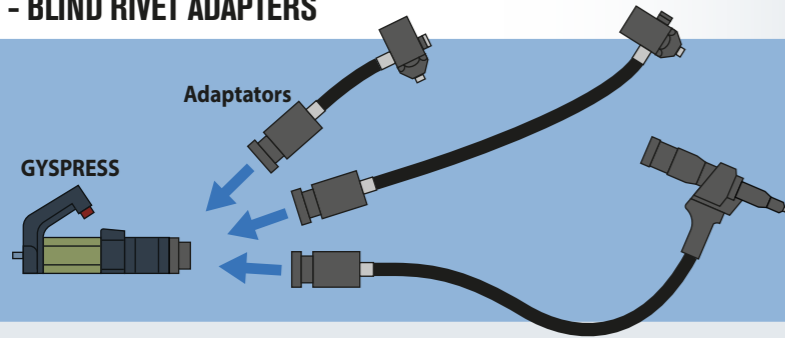

Compatibility	20 kN	24 kN	50 kN
GYSPRESS 8T	✓	✓ (20 kN)	✓ (40 kN)
GYSPRESS 10T	—	✓ (24 kN)	✓ (50 kN)
GYSPRESS 8T PUSH PULL	✓	✓ (20 kN)	✓ (40 kN)
GYSPRESS 10T PUSH PULL	—	✓ (24 kN)	✓ (50 kN)
GYSPRESS 10T CONNECT	—	✓ (24 kN)	✓ (50 kN)

ADAPTATEUR 20 & 24 kN POUR RIVETS AVEUGLES - Blind rivet adapter 20 & 24 kN - Blindnietadapter 20/24 kN



20 kN 150 mm
1.5 kg
059214 891,0 €^{HT}

Pour rivets POP - For BLIND rivets - Für Blindniet
Acier / Steel : Ø 4.0 → 6.4
Alu: Ø 4.0 → 7.8

HIGH ACCESSIBILITY



SPECIFIC STORAGE

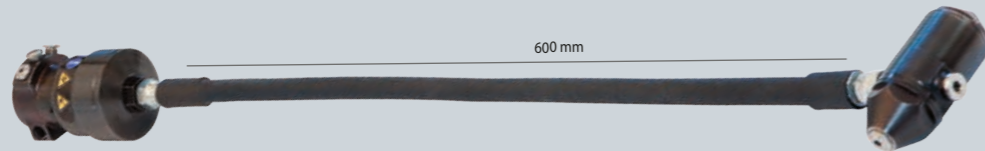
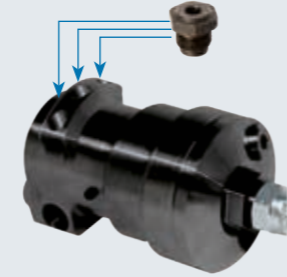

20 kN 600 mm
061576 937,0 €^{HT}

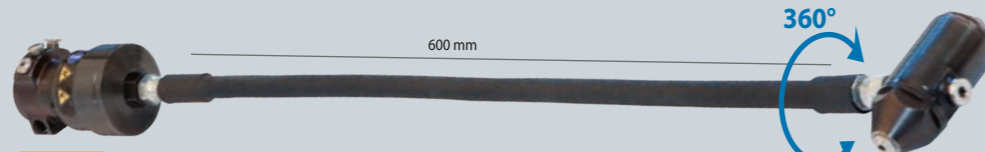

24 kN 600 mm
063822 1 006,0 €^{HT}

INCLUDED (20 kN & 24 kN)

for standard rivets :

Ø 3.2 x 1	059221	15 ^{0€HT}
Ø 3.6 x 1	059238	15 ^{0€HT}
Ø 4.0 x 1	059245	15 ^{0€HT}
Ø 4.5 x 1	059252	15 ^{0€HT}



OPTION

Buse pour extraction de rivets RAP Ø4
- Extraction nozzle for Ø4 SPR rivets
064683 23,0 €^{HT}

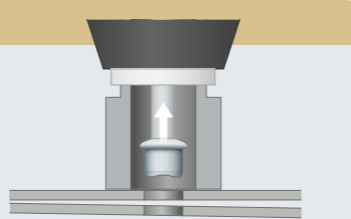
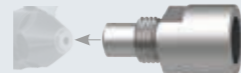

ADAPTATEUR 50 kN POUR RIVETS AVEUGLES - Blind rivet adapter 50 kN - Blindnietadapter 50 kN



50 kN 1 m
064867
1 851,0 €^{HT}
▲ 4.0 kg

Réglage de la course de traction - Stroke adjustment
0 → 25 mm

Pour rivets POP - For BLIND rivets - Für Blindniet

Acier / Steel : Ø 4.0 → 6.4
Alu: Ø 4.0 → 7.8

INCLUDED

Kit Standard



+ Complete kit 065987 91^{0€HT}



OPTIONS

Buse pour extraction de rivets - Extraction nose-piece
066151 23^{0€HT}

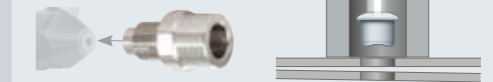

Acier / Steel : Ø 4.0 → 6.4
Alu: Ø 4.0 → 7.8

Extension 160 mm - 160 mm extension - Verlängerung 160 mm

066144 251,0 €^{HT}



Ø 8.0 → 9.8

Kit Rivets Ø8.0/9.8mm - Ø8.0/9.8mm noze-piece kit - Mundstückkit 8,0/9,8 mm

066045 434,0 €^{HT}



M5 → M14

M5 → M8

Kit 6 tirants pour pose d'écrous à sertir - Blind rivet nut pulling adapter kit - Blindnietmuttern-Kit

066076 424,0 €^{HT}

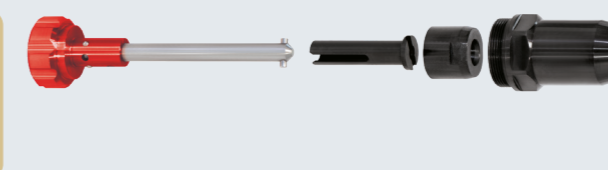

included

M5	066083	69 ^{0€HT}
M6	066090	69 ^{0€HT}
M8	066106	69 ^{0€HT}
M10	066113	80 ^{0€HT}
M12	066120	80 ^{0€HT}
M14	066137	80 ^{0€HT}

PERFECT COMBO WITH ARC PULL SPÉCIAL ARRACHAGE DE RIVETS - Special tearing rivets - Spezial-Zugnieten

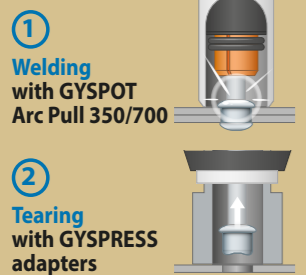

ARC PULL RIVET BOX
for GYSPOT ARC PULL 350
064584 251^{0€HT}

Tige inox - Stainless steel nail Ø 4 x 50 mm x 100 064607 137 ^{0€HT}	Canon pour pose de tige inox - Barrel for stainless steel nail welding x 1 059634 21 ^{0€HT}	Support porte-goujon - Mandrel support x 1 059641 94 ^{0€HT}	Buse + patin pour pistolet Arc Pull - Nozzle + pad for Arc Pull gun x 1 059641 94 ^{0€HT}	Mandrin M4 - Mandrel M4 x 2 049000 36 ^{0€HT}	Canon long - Long barrel x 1 067721
----------------------------------------------------------------------------------------	------------------------------------------------------------------------------------------------------------	----------------------------------------------------------------------------	---------------------------------------------------------------------------------------------------------	-------------------------------------------------------------	-------------------------------------------

BOÎTE CONSOMMABLES POUR ADAPTATEUR 50kN - Consumables box for 50kN adapter - Zubehörbox für 50 kN Adapter



066168 137,0 €^{HT}

Écrous à sertir - Blind rivet nuts	M5	M6	M8	M10	M12	M14
mm	22.5 → 27	24 → 28.5	23.5 → 28	24 → 28.5	23.5 → 28	23.5 → 28
mm	0.5 → 3.0	0.5 → 3.0	0.5 → 3.0	1.0 → 3.5	1.0 → 4.0	4.5 → 6.0
	x 50 066175 26 ^{0€HT}	x 50 066182 26 ^{0€HT}	x 50 066199 26 ^{0€HT}	x 50 066205 41 ^{0€HT}	x 50 066212 41 ^{0€HT}	x 10 066229 94 ^{0€HT}

Goujons à sertir - Blind rivet bolts	M5	M6	M8
mm	22.5 → 27	24 → 28.5	23.5 → 28
mm	0.5 → 3.0	0.5 → 3.0	0.5 → 3.0
	X 50 066236	X 50 066243 35 ^{0€HT}	X 50 066250 46 ^{0€HT}

Rivets aveugles - Blind rivets	Ø 6.4	Ø 9.8
mm	2.8 → 4.8	3.0 → 14.0
	x 50 066267 25 ^{0€HT}	x 50 066274 57 ^{0€HT}

+ plaque de démonstration - demo metal sheet

+ x 10 x 10 x 10 x 10 x 10 x 5

+ x 10 x 10 x 10

+ x 10 x 10



GYSPRESS COMPLETE PACKS

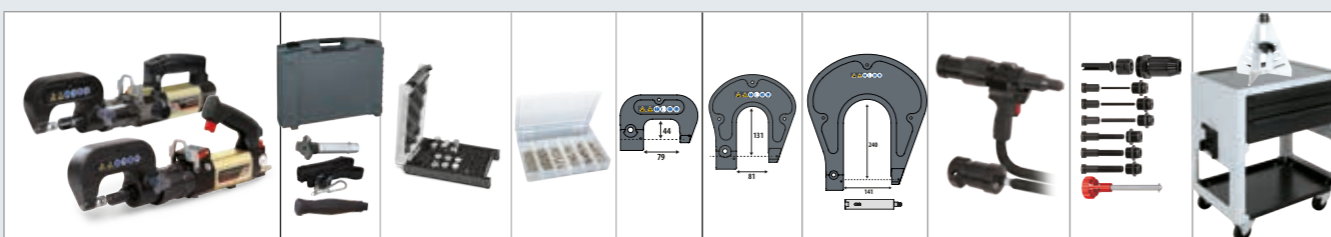

GYSPRESS 10T

pack 1 - GYSPRESS 10T 066441 5 528,0 €HT	063303				HR210 063327	HR310 063334			
	Accessories	Standard 8T/10T 053694	6 x 50 rivets 048706	HR110 063310					
pack 2 - GYSPRESS 10T 066458 7 978,0 €HT	063303				HR210 063327	HR310 063334	50kN adapter 064867	Pulling adapter kit 066076	
	Accessories	Standard 8T/10T 053694	6 x 50 rivets 048706	HR110 063310					
pack 3 - GYSPRESS 10T 064744 5 995,0 €HT	063303				HR210 063327	HR310 063334			Trolley+support 055391
	Accessories	Standard 8T/10T 053694	6 x 50 rivets 048706	HR110 063310					

GYSPRESS 8T PUSH PULL

pack GYSPRESS 8T PUSH PULL 058682 6 321,0 €HT	056893				HR2 053878	PP HR3 058903			Trolley+support 055391
	Accessories	Standard 8T/10T PP 058361	6 x 50 rivets 048706	HR15 054219					

GYSPRESS 10T PUSH PULL

pack 1 - GYSPRESS 10T PUSH PULL 066465 6 512,0 €HT	063853				HR210 063327	HR310 063334			
	Accessories	Standard 8T/10T PP 058361	6 x 50 rivets 048706	HR110 063310					
pack 2 - GYSPRESS 10T PUSH PULL 066472 8 963,0 €HT	056893				HR210 063327	HR310 063334	50kN adapter 064867	Pulling adapter kit 066076	
	Accessories	Standard 8T/10T PP 058361	6 x 50 rivets 048706	HR110 063310					
pack 3 - GYSPRESS 10T PUSH PULL 065789 6 980,0 €HT	056893				HR210 063327	HR310 063334			Trolley+support 055391
	Accessories	Standard 8T/10T PP 058361	6 x 50 rivets 048706	HR110 063310					



RIVETEUSE HYDRO-PNEUMATIQUE - Hydro-pneumatic tool for blind rivets - Hydro-pneum. Blindnietgerät

HR9

Pour rivets POP - For BLIND rivets - Für Blindniet
 Acier / Steel Ø 3.2/4.0/4.8
 Alu Ø 3.2/4.0/4.8

max 9 000 N

057234 **219,0 €HT**

Made in Taiwan



RIVETEUSE HYDRO-PNEUMATIQUE - Hydro-pneumatic tool for blind rivets - Hydro-pneum. Blindnietgerät

HR14

Pour rivets POP - For BLIND rivets - Für Blindniet
 Acier / Steel Ø 4.0/4.8/6.4
 Alu Ø 4.0/4.8/6.4

max 14 000 N

057241 **389,0 €HT**

Made in Taiwan



RIVETEUSE SUR BATTERIE - Cordless riveter - Akku-Blindnietgerät

TWO ER20

Pour rivets POP - For BLIND rivets - Für Blindniet
 Ø 4.0/4.8/5.0/6.0/6.4

max 20 000 N (6 bar)

10-20 V universal fast charger (30 min)
 2.0 kg



2x
 20V/2Ah Li-ion battery



RIVETEUSE MANUELLE - Manual tool for blind rivets - Manueller Blindnietgerät

Pour rivets POP - For BLIND rivets - Für Blindniet

Acier / Steel Ø 3.2/4.0/4.8/6./6.4
 Alu Ø 3.2/4.0/4.8/6./6.4

061323 **185,0 €HT**

Made in Taiwan



SERTISSEUSE HYDRO-PNEUMATIQUE RIV 998 - Hydro-pneumatic tool for rivet nuts - Hydro-pneum. Blindnietmuttergerät

RIV 998

Ecrous à sertir - Sealing nuts - Blindnietmuttern

Pour la pose d'écrous à sertir M4 à M12

max 19 000 N (6 bar)

livré avec accessoires pour écrous à sertir M4 à M12

055414 **2 116,0 €HT**



RIVETEUSE HYDRO-PNEUMATIQUE - Hydro-pneumatic tool for blind rivets - Hydro-pneum. Blindnietgerät

HR21

Pour rivets POP - For BLIND rivets - Für Blindniet
 Ø 4.0 → 7.8

max 21 000 N (6 bar)

055407 **2 276,0 €HT**



- included (x3)
 058446
 39,0€HT
- For standard rivets
 Ø 4.0
 51508
- For Magnarive rivets
 Ø 4.5
 51507

Option HR21 extension
 100 mm
 063105 **366,0€HT**

GMAW MIG/MAG SYNERGIC



CARMIG

15 → 200 A
400V • 3~

with accessories
032132 **1 110,0 €HT**

NEW DESIGN

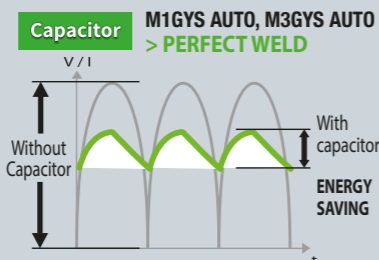

M1 GYS AUTO

15 → 160 A Capacitor

230V • 1~
with accessories
032903 **1 361,0 €HT**
208/240V • 1~
with accessories
032088 **1 498,0 €HT**

T1 GYS AUTO

15 → 200 A

400V • 3~
with accessories
032910 **1 384,0 €HT**

T1 GYS AUTO DV

15 → 200 A

230V • 3~ / 400V • 3~
with accessories
032927 **1 658,0 €HT**



SYNERGIC - EASY TO USE
Réglage automatique de la vitesse \ Auto adaptative wire speed
Automatische Einstellung der Drahtgeschwindigkeit

100% READY

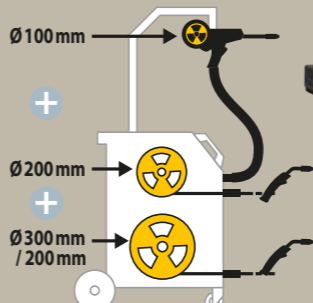

M3 GYS AUTO

15 → 160 A Capacitor

230V • 1~
with accessories:
032880 **2 491 €HT**

T3 GYS AUTO

15 → 200 A

400V • 3~
with accessories:
032958 **2 806 €HT**

with accessories:
032941 **2 258 €HT**

T3 GYS AUTO DV

15 → 200 A

230V • 3~ / 400V • 3~
with accessories:
032972 **2 855 €HT**

NEW DESIGN



câble secteur - mains cable
6m

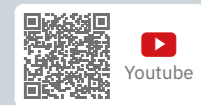

AUTOGYS
GMAW
FCAM
CARBODY SYNERGIC MIG

Torche motorisée Spool Gun - Spool Gun Torch - Spool Gun Brenner



SPOOL GUN + Support for M3 & T3 GYS AUTO

038554 **473 €HT**



T3GYS & M3GYS:
Housse de protection - Protection cover - Schutzhaube
052260 **194 €HT**



Protection gas
Argon+CO₂ (Steel, Inox)
Argon (ALU/CuSi3/CuAl8)
CO₂PUR (Steel)

MADE IN FRANCE	MADE IN CHINA	NORM. 60974/1	50/60 Hz	A	min → max	Reg	Ø mm			Electronic Control	EN60974-1 (40°C)			Equipment d'origine Original equipment Originalausstattung Equipamiento de fábrica	cm/kg	Protected & compatible power generator (+/-15%)	
							100 (spoolgun)	200	300		IA (60%)	X% (I2 max)	Ø mm				
		CARMIG	400V 3~	10	15 → 200	7	-	-	-	electronic	110	150A@25%	0,6+1	0,6/0,8	0,8	47x77x79 / 50	5 kVA
		M1GYS AUTO	230V 1~ 208/240V 1~	16	15 → 160	6	option	-	-	400	90	140A@15%	0,6+1	0,6/0,8	0,8	47x77x79 / 46	4,5 kVA
		T1GYS AUTO T1GYS AUTO DV	400V 3~ 230V 3~/400V 3~	10	15 → 200	7	option	-	-	400	110	150A@25%	0,6+1	0,6/0,8	0,8	47x77x79 / 52	5.2 kVA
		M3GYS AUTO	230V 1~ 208/240V 1~	16	15 → 160	6	-	-	-	400	90	140A@15%	0,6+1	0,6/0,8 0,8/1,0	2 x 0,8	60x90x90 / 58	4,5 kVA
		T3GYS AUTO T3GYS AUTO DV	400V 3~ 230V 3~/400V 3~	10	15 → 200	7	-	-	-	400	110	150A@25%	0,6+1	0,6/0,8 0,8/1,0	2 x 0,8	60x90x90 / 75	5.2 kVA



GMAW MIG/MAG INVERTER • SYNERGIC

4
in 1

GAS	NO GAS
MMA	TIG

1 MIG / MANUAL
Enter your parameters

Adjust Spot & Delay

2 MIG / SYNERGIC
Easy to use

Select:

- 1. material
- 2. Ø wire
- 3. position
- 4. thickness

Adjust arc length

Fe	CrNi
AlMg5	CuSi3
AlSi5	AlSi12
CuAl8	F.C.

3 MMA

HotStart ArcForce

4 TIG lift

Post Gas Downslope



MULTEPEARL 210-2

200 A ⚡ ⚡ ⚡ ⚡ ⚡ ⚡ ⚡ ⚡ ⚡ ⚡

P400 PFC FV SR

GAS	NO GAS	MMA	TIG
-----	--------	-----	-----

3 m 2.5 m, 16 mm² 2 m, 16 mm²

065093

MULTEPEARL 210-4 XL

200 A ⚡ ⚡ ⚡ ⚡ ⚡ ⚡ ⚡ ⚡ ⚡ ⚡

P400 PFC FV SR

GAS	NO GAS	MMA	TIG
-----	--------	-----	-----

3 m 2.5 m, 16 mm² 2 m, 16 mm²

065109

MULTEPEARL 211-4

200 A ⚡ ⚡ ⚡ ⚡ ⚡ ⚡ ⚡ ⚡ ⚡ ⚡

P400 PFC FV SR

GAS	NO GAS	MMA	TIG
-----	--------	-----	-----

3 m 2.5 m, 16 mm² 2 m, 16 mm²

065116

PFC POWER FACTOR CORRECTION
185 V ↔ 265 V

FV FLEXIBLE VOLTAGE
85 V ↔ 265 V

SR SECONDARY REGULATION
I (A) STABLE

NO GAS

KIT SOUDAGE NO GAZ Ø 0.9
- No Gas Welding Kit Ø 0.9
- Schweißset Fülldraht

TYPE A
MultiPearl 200-2 only
041240 2330 € HT

TIG torch kit SR17 V (valve)
4 m
10/25 mm²
044425 9627 € HT

TIG torch kit SR17 DB
4 m
046108 16327 € HT

EURO

MADE IN FRANCE EN60974-1	50/60 Hz		I ₂			EN60974-1 (40°C)		MIG			Equipment d'origine			cm	kg	7.5 kW			
	A	A	A	A	A	U ₀ (V)	Electronic Control	max	min	100	200	300	GAS				NO GAS	MMA	TYPE
MULTIPEARL 210-2	110V 1~	32	20+130	20+180	20+150	100	150 A @ 22%	75	15	■	■	—	0.6+1.0	0.9+1.2	1.6+3.2	A	25 x 45 x 35	16	7.5 kW
	230V 1~	13	20+200	20+200	20+200	130	200 A @ 20%	76	15	■	■	—	0.6+1.0	0.9+1.2	1.6+5.0	A	25 x 45 x 35	16	7.5 kW
MULTIPEARL 210-4 XL	110V 1~	32	20+130	20+180	20+150	100	150 A @ 22%	75	15	■	■	—	0.6+1.0	0.9+1.2	1.6+3.2	B	25 x 55 x 44	20	7.5 kW
	230V 1~	13	20+200	20+200	20+200	130	200 A @ 20%	76	15	■	■	—	0.6+1.0	0.9+1.2	1.6+5.0	B	25 x 55 x 44	20	7.5 kW
MULTIPEARL 211-4	110V 1~	32	20+130	20+180	20+150	100	150 A @ 22%	75	15	■	■	—	0.6+1.0	0.9+1.2	1.6+3.2	B	41 x 73 x 77	37	7.5 kW
	230V 1~	13	20+200	20+200	20+200	130	200 A @ 20%	76	15	■	■	—	0.6+1.0	0.9+1.2	1.6+5.0	B	41 x 73 x 77	37	7.5 kW



AUTOPULSE

GMAW MIG/MAG INVERTER DOUBLE PULSE

Latest generation colour screen 5" / 800 x 480 (WVGA)



3 WELDING MODES :

1 EASY

2 EXPERT
Pre-gas / Hot Start / Upslope / Downslope / Crater filler / Post-gas

3 ADVANCED
Arc length adjustments

Up to 500 JOBS can be saved



Traceability **NEW**



Portability **NEW**



PROCESSES

- Dynamic standard
- Pulse
- Pulse in Pulse
- Manual
- Cold Pulse**

FULLY DIGITAL

- 4 MICROPROCESSORS
- DSP**

65+ SYNERGIES

- STEEL
- Cu Si 3 / Cu Al 8**
- ALU

EASY USB UPDATE



	AUTOPULSE 220-M1	AUTOPULSE 220-M3	AUTOPULSE 220-M3 208-240V
1	1 Ø 200 → 300 mm PP	1 Ø 200 mm PP	1 Ø 200 mm PP
2	- - - -	2 Ø 200 mm PP	2 Ø 200 mm -
3	- - - -	3 Ø 200 mm -	3 Ø 200 mm -

**BODYSHOP SPECIFIC
COLD PULSE
CuSi3 Ø 0.8 / 1**



AUTOPULSE 220-M1

15 220 A 230V 1~
PFC
065024 5 194,0 €HT

AUTOPULSE 220-M3

15 220 A 230V 1~
PFC
036703 6 140,0 €HT

AUTOPULSE 220-M3 208-240V

15 220 A 208>240V 1~
PFC
062481 6 140,0 €HT

PUSH PULL TORCH 24V
details p. 72

MB 15
4m
044111
1 202,00 €HT

MB 25
4m
046283
1 224,00 €HT

SPOOLGUN TORCH
details p. 72

Motor inside

Ideal Alu
Ø 0,8

4m 041486 351,82 €HT

MB 15 / MB 25 (250 A)
037458 35,00 €HT

- x5 (M6-0.8)
- x5 (M6-1.0)
- x5 (Alu-M6-0.8)
- x5 (M6-0.8)
- x5 (M6-1.0)
- x5 (Alu-M6-0.1.0)
- x5 (Alu-M6-1.1.2)

Débimètre de bout de torche

053939 26,15 €HT

Housse de protection - Protection cover - Schutzhaube

052260 194,00 €HT

MADE IN FRANCE CE NORM. EN60974-1	50 / 60 Hz	A	Ø mm	A	SPOOLGUN	PUSH/PULL	200	300	Cooling system	EQUIPEMENT D'ORIGINE Original equipment Originalausstattung Equipamento de fabrica	EN60974-1 (40°C)			Protected & compatible power generator (+/-15%)
											IA (60%)	X% (I2 max)	cm / kg	
AUTOPULSE 220-M1	230 V · 1~	16	0.6 → 1.2	15 → 220	-	OPTION	■	■	Air	ALU : Type B 1.0 / 1.2	150	220 A @ 20%	88x93x63 / 69	10 kVA
AUTOPULSE 220-M3	230 V · 1~	16	0.6 → 1.2	15 → 220	OPTION	OPTION	■	-	Air	ACIER : Type B 0.8 / 1.0 mm ALU : Type B 1.0 / 1.2	150	220 A @ 20%	88x93x63 / 69	10 kVA
AUTOPULSE 220-M3 208-240V	208 > 240 V · 1~	16	0.6 → 1.2	15 → 220	-	OPTION	■	-	Air	ACIER : Type B 0.8 / 1.0 mm ALU : Type B 1.0 / 1.2	150	220 A @ 20%	88x93x63 / 69	10 kVA

GMAW MIG/MAG INVERTER DOUBLE PULSE



PFC POWER FACTOR CORRECTION

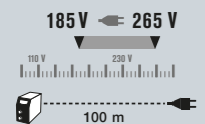

AUTOPULSE 320-T3

15 **320 A** 400V 3~

PFC
036710 **8 492,0 €HT**

AUTOPULSE 320-T3 208-240V

15 **320 A** 208>240V 3~

PFC
036970 **8 386,0 €HT**

	AUTOPULSE 320-T3				AUTOPULSE 320-T3 208-240V			
1	1	Ø 200 mm	PP	1	Ø 200 mm	PP		
2	2	Ø 200 mm		2	Ø 200 mm			
3	3	Ø 200 mm		3	Ø 200 mm			



BODYSHOP SPECIFIC
COLD PULSE
CuSi3 Ø 0.8/1

	50/60 Hz	A	Ø mm	A	SPOOLGUN	PUSHPULL	200	Cooling system	ELECTRONIC CONTROL	IA (60%)	X% (I2 max)	cm / kg	Protected & compatible power generator (+/-15%)
AUTOPULSE 320-T3	400 V - 3~	16	0.8+1.2	15+320	OPTION	OPTION	■	Air	ACIER : Type C 0.8 / 1.0 mm ALU : Type C 1.0 / 1.2	260	320 A @ 35%	90x92,5x63 / 82.5	16 kVA
AUTOPULSE 320-T3 208-240V	208-240 V - 3~	25	0.8+1.2	15+320	—	OPTION	■	Air	ACIER : Type C 0.8 / 1.0 mm ALU : Type C 1.0 / 1.2	260	320 A @ 35%	90x92,5x63 / 82.5	16 kVA

PUSH PULL TORCH 24 V

details p. 72
MB 15
4m
044111
1 202,8 €HT

MB 25
4m
046283
1 224,2 €HT



MB 15 / MB 25 (250 A)
037458 35,6 €HT

- x5 (Mg-Ø 0.8)
- x5 (Mg-Ø 1.0)
- x5 (Alu - Mg-Ø 0.8)
- x5 (Mg-Ø 0.8)
- x5 (Mg-Ø 1.0)
- x5 (Alu - Mg-Ø 1.0)
- x5 (Alu - Mg-Ø 1.2)

SPOOLGUN TORCH

details p. 72
Ideal Alu
Ø 0,8

4m 041486 351,82 €HT



Débitmètre de bout de torche
053939
26,15 €HT

Housse de protection
- Protection cover
- Schutzhaube
052260
19,4 €HT



AUTOPULSE ~1ph 220A CONFIGURATIONS

AUTOPULSE 220-M1						
065024 5 194,0 €HT	NEW	4 m, 35 mm ² 043817	—	—	Alu 250 A, 3 m, air Ø 1.2	
AUTOPULSE 220-M3 230 V						
036703 6 140,0 €HT		4 m, 35 mm ² 043817		CuSi 150 A, 3 m, air Ø 1.0	Steel 150 A, 3 m, air Ø 0.8	Alu 250 A, 3 m, air Ø 1.2
AUTOPULSE 220-M3 208-240 V						
062481 6 140,0 €HT	NEW	4 m, 35 mm ² 043817		CuSi 150 A, 3 m, air Ø 1.0	Steel 150 A, 3 m, air Ø 0.8	Alu 250 A, 3 m, air Ø 1.2

AUTOPULSE ~3ph 320A CONFIGURATIONS

AUTOPULSE 320-T3 400V						
036710 8 492,0 €HT		4 m, 35 mm ² 043817				
PACK 1 059184 8 959,0 €HT		4 m, 35 mm ² 043817		Steel 250 A, 3 m, air Ø 1.0	Steel 250 A, 3 m, air Ø 1.0	Alu 250 A, 3 m, air Ø 1.0
PACK 2 059191 10 221,0 €HT		4 m, 35 mm ² 043817		Steel 250 A, 3 m, air Ø 1.0	Steel 250 A, 3 m, air Ø 1.0	Alu Push-Pull - MB25 - 4 m Ø 1.2
AUTOPULSE 320-T3 208-240V						
036970 8 386,0 €HT	NEW	4 m, 35 mm ² 043817				
PACK 1 065826 NEW		4 m, 35 mm ² 043817		Steel 250 A, 3 m, air Ø 1.0	Steel 250 A, 3 m, air Ø 1.0	Alu 250 A, 3 m, air Ø 1.0
PACK 2 065833 NEW		4 m, 35 mm ² 043817		Steel 250 A, 3 m, air Ø 1.0	Steel 250 A, 3 m, air Ø 1.0	Alu Push-Pull - MB25 - 4 m Ø 1.2

TORCHES MANUELLES - Manual Torches - Brenner - Antorcha - Lastoort - Tocha

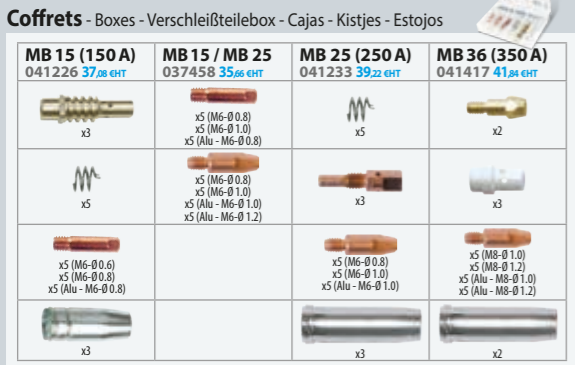
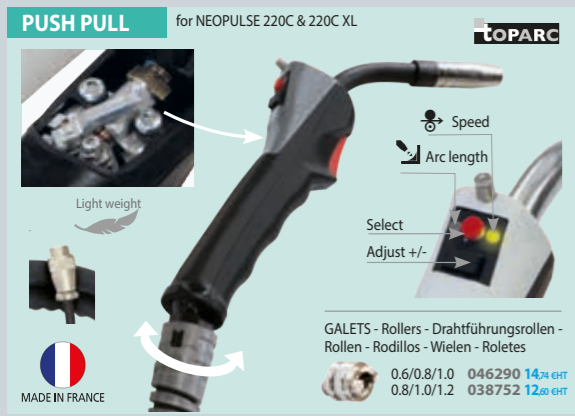

Gaines - Torch liners - Mantel - Funda - Drahtseelen - Folha

ACIER - STEEL - STAHL - ACERO - STAAL - AÇO	TEFLON	CARBON																																																															
<table border="1"> <tr><th>Ø 0.6/0.8</th><th>3m</th><td>041592 8,56 €HT</td></tr> <tr><td></td><th>4m</th><td>041837 9,51 €HT</td></tr> <tr><td></td><th>5m</th><td>041608 7,94 €HT</td></tr> <tr><td></td><th>6m</th><td>041844 9,28 €HT</td></tr> <tr><td></td><th>8m</th><td>062276 13,07 €HT</td></tr> <tr><td></td><th>12m</th><td>418417 8,52 €HT</td></tr> <tr><td></td><th>16m</th><td>418424 10,22 €HT</td></tr> <tr><td></td><th>20m</th><td>062283 13,07 €HT</td></tr> <tr><td></td><th>24m</th><td>040526 9,51 €HT</td></tr> <tr><td></td><th>30m</th><td>062290 13,07 €HT</td></tr> </table>	Ø 0.6/0.8	3m	041592 8,56 €HT		4m	041837 9,51 €HT		5m	041608 7,94 €HT		6m	041844 9,28 €HT		8m	062276 13,07 €HT		12m	418417 8,52 €HT		16m	418424 10,22 €HT		20m	062283 13,07 €HT		24m	040526 9,51 €HT		30m	062290 13,07 €HT	<table border="1"> <tr><th>Ø 0.6/0.8</th><th>3m</th><td>041578 19,23 €HT</td></tr> <tr><td></td><th>4m</th><td>044050 25,20 €HT</td></tr> <tr><td></td><th>5m</th><td>041585 19,23 €HT</td></tr> <tr><td></td><th>6m</th><td>044067 23,38 €HT</td></tr> <tr><td></td><th>8m</th><td>038677 50,35 €HT</td></tr> <tr><td></td><th>12m</th><td>044074 23,38 €HT</td></tr> </table>	Ø 0.6/0.8	3m	041578 19,23 €HT		4m	044050 25,20 €HT		5m	041585 19,23 €HT		6m	044067 23,38 €HT		8m	038677 50,35 €HT		12m	044074 23,38 €HT	<table border="1"> <tr><th>Ø 0.6/0.8</th><th>4m</th><td>039834 36,01 €HT</td></tr> <tr><td></td><th>5m</th><td>062306 56,01 €HT</td></tr> <tr><td></td><th>6m</th><td>039827 31,38 €HT</td></tr> <tr><td></td><th>8m</th><td>062313 34,94 €HT</td></tr> <tr><td></td><th>12m</th><td>039810 39,22 €HT</td></tr> </table>	Ø 0.6/0.8	4m	039834 36,01 €HT		5m	062306 56,01 €HT		6m	039827 31,38 €HT		8m	062313 34,94 €HT		12m	039810 39,22 €HT
Ø 0.6/0.8	3m	041592 8,56 €HT																																																															
	4m	041837 9,51 €HT																																																															
	5m	041608 7,94 €HT																																																															
	6m	041844 9,28 €HT																																																															
	8m	062276 13,07 €HT																																																															
	12m	418417 8,52 €HT																																																															
	16m	418424 10,22 €HT																																																															
	20m	062283 13,07 €HT																																																															
	24m	040526 9,51 €HT																																																															
	30m	062290 13,07 €HT																																																															
Ø 0.6/0.8	3m	041578 19,23 €HT																																																															
	4m	044050 25,20 €HT																																																															
	5m	041585 19,23 €HT																																																															
	6m	044067 23,38 €HT																																																															
	8m	038677 50,35 €HT																																																															
	12m	044074 23,38 €HT																																																															
Ø 0.6/0.8	4m	039834 36,01 €HT																																																															
	5m	062306 56,01 €HT																																																															
	6m	039827 31,38 €HT																																																															
	8m	062313 34,94 €HT																																																															
	12m	039810 39,22 €HT																																																															
PUSH PULL TORCH																																																																	
Ø 1.0/1.2	8m	038172 39,20 €HT																																																															

CONSOUMABLES - Consumables

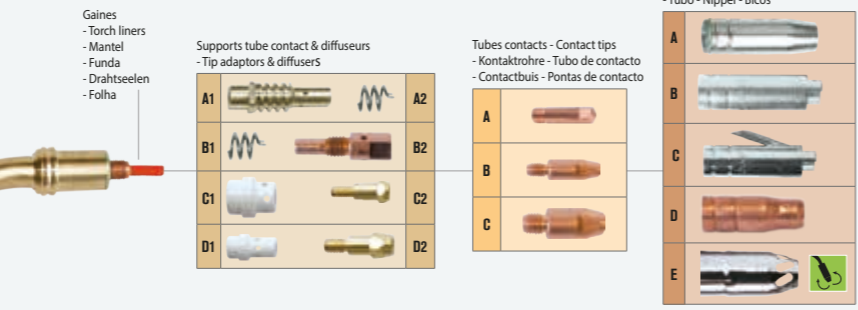

Torches complètes - Complete Torches - Brenner - Antorcha - Lastoort - Tocha

	Acier / Inox - Steel/Stainless steel - Stahl/Edelstahl				ALU - Aluminium - Aluminio				PUSH PULL		SPOOL GUN
	AIR	LIQUID	AIR	LIQUID	AIR	LIQUID	AIR	AIR	AIR	AIR	
X% 40°C, ArCo ₂	150A	200A	290A	270A	150A	200A	290A	270A	160A	220A	150A
	60%	60%	60%	100%	60%	60%	60%	100%	40%	20%	100%
	A1+A2	B1+B2	D1+D2	C1+C2	A1+A2	B1+B2	D1+D2	C1+C2	A1+A2	B1+B2	A1+A2
	M6	M6	M8	M6	M6	M6	M8	M6	M6	M6	M6
	Ø0.8	Ø1.0	Ø1.2	Ø1.2	Ø0.8	Ø1.0	Ø1.2	Ø1.2	Ø1.0	Ø1.2	Ø0.8
	3m	4m	4m	3m	3m	3m	3m	3m	4m	4m	4m
	063754	063778	063792	040694	063761	063785	063808	040748	044111	046283	041486
	54,44 €HT	87,35 €HT	121,28 €HT	266,24 €HT	60,62 €HT	83,88 €HT	115,05 €HT	323,29 €HT	120,28 €HT	1224,23 €HT	351,82 €HT
	041424	040700	040687	043275	041462	040724	CARBON	043282			
	67,94 €HT	120,28 €HT	159,28 €HT	297,14 €HT	80,39 €HT	125,51 €HT	040731	301,36 €HT			
							167,35 €HT				
	3m	4m	4m		4m	4m					
	043268	040922	040946		040939	CARBON					
	86,77 €HT	132,88 €HT	188,27 €HT		139,28 €HT	040953					
						196,59 €HT					
	3m	3m	4m								
	043251	040540	040557								
	565,76 €HT	648,96 €HT	753,35 €HT								

Supports tube contact & diffusers - Tip adaptors & diffusers

	Acier / Inox - Steel/Stainless steel - Stahl/Edelstahl				ALU - Aluminium - Aluminio				PUSH PULL		SPOOL GUN
	AIR	LIQUID	AIR	LIQUID	AIR	LIQUID	AIR	AIR	AIR	AIR	
	150A	250A	350A	300A	150A	250A	350A	300A	150A	250A	150A
	A1 (x5)	B1 (x5)	D1 (x3)	C1 (x3)	A1 (x5)	B1 (x5)	D1 (x3)	C1 (x3)	A1 (x5)	B1 (x5)	A1 (x5)
	042902	042995	043008	043589	042902	042995	043008	043589	042902	042995	042902
	25,44 €HT	3,89 €HT	5,71 €HT	4,89 €HT	25,44 €HT	3,89 €HT	5,71 €HT	4,89 €HT	25,44 €HT	3,89 €HT	25,44 €HT
	A2 (x10)	B2 (x5)	D2 (x5)	C2 (x5)	A2 (x10)	B2 (x5)	D2 (x5)	C2 (x5)	A2 (x10)	B2 (x5)	A2 (x10)
	042988	042919	042926	043541	042988	042919	042926	043541	042988	042919	042988
	6,89 €HT	11,89 €HT	13,55 €HT	11,17 €HT	6,89 €HT	11,89 €HT	13,55 €HT	11,17 €HT	6,89 €HT	11,89 €HT	6,89 €HT

Tubes contacts - Contact tips - Kontaktrohre - Tubo de contacto - Contactbuis - Pontas de contacto

	150A	250A	350A	300A	150A	250A	350A	300A	150A	250A	150A
Ø 0.6	A (x10) 041905 5,71 €HT	A (x10) 041905 5,71 €HT	—	A (x10) 041905 5,71 €HT	—	—	—	—	—	—	—
Ø 0.8	A (x10) 041912 5,71 €HT	B (x10) 041950 8,89 €HT	C (x10) 041790 10,89 €HT	B (x10) 041950 8,89 €HT	B (x10) 041059 9,27 €HT	B (x10) 041059 9,27 €HT	—	B (x10) 041059 9,27 €HT	B (x10) 041059 9,27 €HT	B (x10) 041059 9,27 €HT	B (x10) 041059 9,27 €HT
Ø 1.0	A (x10) 041929 5,71 €HT	B (x10) 041967 8,89 €HT	C (x10) 041903 10,89 €HT	B (x10) 041967 8,89 €HT	B (x10) 041066 10,89 €HT	B (x10) 041066 10,89 €HT	C (x10) 041976 14,28 €HT	B (x10) 041066 10,89 €HT	B (x10) 041066 10,89 €HT	B (x10) 041066 10,89 €HT	B (x10) 041066 10,89 €HT
Ø 1.2	A (x10) 040144 5,71 €HT	B (x10) 041974 8,89 €HT	C (x10) 041910 10,89 €HT	B (x10) 041974 8,89 €HT	B (x10) 041073 10,89 €HT	B (x10) 041073 10,89 €HT	C (x10) 041973 14,28 €HT	B (x10) 041073 10,89 €HT	B (x10) 041073 10,89 €HT	B (x10) 041073 10,89 €HT	B (x10) 041073 10,89 €HT
Ø 1.4	—	—	C (x10) 041982 10,89 €HT	—	—	—	—	—	—	—	—
Ø 1.6	—	—	C (x10) 041984 10,89 €HT	—	—	—	C (x10) 041080 14,28 €HT	—	—	—	—
Ø 2.4	—	—	C (x10) 040533 11,41 €HT	—	—	—	—	—	—	—	—

Buses - Gas nozzles - Düsen - Tubo - Nippel - Bicos

	150A	250A	350A	300A	150A	250A	350A	300A	150A	250A	150A
Conique Conical nozzle Koniche Düse	A (x3) 041875 8,08 €HT	A (x3) 041882 12,12 €HT	A (x3) 041783 19,02 €HT	A (x3) 043534 11,41 €HT	A (x3) Ø12 041875 8,08 €HT	A (x3) 041882 12,12 €HT	A (x3) 041783 19,02 €HT	A (x3) 043534 11,41 €HT	A (x3) 041875 8,08 €HT	A (x3) 041882 12,12 €HT	A (x3) 041875 8,08 €HT
Pointage Spot welding Punktöse	B (x1) 041851 7,91 €HT	—	—	—	A (x3) Ø16 046214 12,84 €HT	—	—	—	—	—	—
Soudé clou Nail welding Nagel-schweißdüse	C (x1) 041523 18,78 €HT	—	—	—	—	—	—	—	—	—	—
Special No Gas (isolated)	D (x1) 041868 6,18 €HT	—	—	—	—	—	—	—	—	—	—

BOBINES DE FIL - Welding wire reels - Drahtrollen - Rollos de hilo - Draadbobbijn - Bobines de filo

for	kg	Ø 0.6 mm	Ø 0.8 mm	Ø 0.9 mm	Ø 1.0 mm	Ø 1.2 mm	EXCELLIUM			NORMES - Norms - Normen - Norma						
							Ø 0.8 mm	Ø 1.0 mm	Ø 1.2 mm	AWS	EN	DIN				
Acier - Steel - Stahl - Acero - Staal - Aço (SG2)	0.9	100 mm	086593 9,25 €HT	086609 9,25 €HT												
	5	200 mm	086111 30,19 €HT	086128 20,92 €HT		086135 19,97 €HT								5.18 : ER 70S-6	ISO 14341-A : G46 4M G3Si1	8559 : SG2
	15	300 mm	086166 92,20 €HT	086227 58,25 €HT		086234 54,91 €HT		086241 51,35 €HT		086302 73,22 €HT	086319 71,88 €HT			5.18 : ER 70S-3	ISO 14341-A : G42 2M 2Si1	8559 : SG1
	18	—	300 mm	086272 64,18 €HT		086289 68,94 €HT	086296 67,04 €HT							5.28 : ER 90S-B3	ISO 2195L-A : Cr CrMo2Si	—
	5	200 mm	086418 31,18 €HT	086401 23,33 €HT										ASME SFA-5.28 : ER 120 S-G	ISO 12534 : Mn4Ni2, 5CrMo	—
	0.9	100 mm			086104 18,44 €HT									5.20 : E71T-G5	ISO 17632-A T42 Z W N 1 H15	—
	4.5	200 mm		086265 82,01 €HT	086623 76,78 €HT	086630 65,61 €HT								—	—	—
	15	300 mm		086388 203,01 €HT	086395 200,87 €HT									—	—	—
	16	—	300 mm				086173 335,18 €HT							—	14700 : TZ Fe 2	8559 : MSG 6-CF-60
	5	200 mm		086760 65,25 €HT	086777 53,25 €HT									5.18 : ER 70S-2	ISO 14341-A : G42 2 M G2Ti	8559 : SG2
Cusi3 HLE - UHTS (Boron Steel)	1	100 mm		086692 47,87 €HT										5.7 : ER CuSi-A	ISO 14640 : S Cu 6560	1733 : SG-CuSi3
	5	200 mm		086647 172,11 €HT		086654 173,33 €HT		086210 299,92 €HT						—	—	—
CuAl8 HLE - UHTS (Boron Steel)	5	200 mm		086661 171,88 €HT		086197 171,88 €HT								5.7 : ER CuAl-A1	ISO 14640 : S Cu 6100	1733 : SG-CuAl8
	15	300 mm				086180 501,38 €HT								—	—	—
Inox - Stainless - Edelstahl (308LSi)	1	100 mm		086616 26,39 €HT										5.9 : ER 308L Si	ISO 14343-A : G19 9 L Si	8556 : SG X2CrNi 19 9
	5	200 mm		086579 96,25 €HT		086340 89,38 €HT								—	—	—
	15	300 mm				086357 227,97 €HT								—	—	—
Inox - Stainless - Edelstahl (316LSi)	5	200 mm		086326 109,21 €HT		086364 107,21 €HT								5.9 : ER 316L Si	ISO 14343-A : G19 12 3 L Si	8556 : SG X2 CrNiMo 19 12
	15	300 mm				086371 286,24 €HT								—	—	—
	2	200 mm				086517 53,38 €HT		086500 152,61 €HT						5.10 : ER 5554	ISO 18273 : S Al 5554	1732 : SG-AIMg3
Alu (AlMg3)	7	300 mm												—	—	—
	0.5	100 mm				086548 16,44 €HT								5.10 : ER 5356	ISO 18273 : S Al 5356	1732 : SG-AIMg5
	2	200 mm				086555 50,16 €HT		086562 48,23 €HT		086524 147,38 €HT	086531 146,63 €HT			—	—	—
Alu (AlMg5)	7	300 mm												—	—	—
	7	—	300 mm							086487 179,85 €HT	086494 171,88 €HT			—	—	—
	0.5	100 mm				086685 15,58 €HT								5.10 : ER 4043	ISO 18273 : S Al 4043-A	1732 : SG-AISi5
Alu (AlSi5)	2	200 mm								086142 45,80 €HT	086159 42,31 €HT			—	—	—
	0.5	100 mm												—	—	—
	2	200 mm												5.10 : ER 4047	ISO 18273 : S Al 4047	1732 : SG-AISi12
Alu (AlSi12)	0.5	100 mm												—	—	—
	2	200 mm								086067 49,21 €HT	086074 47,28 €HT			—	—</	

Battery charger
037472 20⁹⁰ €HT
☎ : 028869

Battery included
037465 98⁴¹ €HT

x1
038424 20⁹⁰ €HT

x5
038417 5⁰⁷ €HT

Filtration class
EN 12941 : TH2 P R SL
Air 165 / 200 / 220 L/min
Battery included

OPTION
Filter TH3
065734 23⁹⁰ €HT

GYSMATIC 5/13 AIR XXL TRUECOLOR
047846 732,16 €HT
☎ : 028852

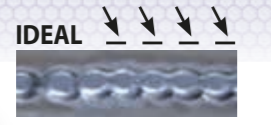

DIGITAL

MEMORY & REGULATIONS ELECTRONIC

memory saving x3

COMFORT PRO

COMFORTABLE BACK

GYSMATIC XXL TRUECOLOR
037236 209,19 €HT

100 x 83 mm 0.10 ms

GRIND + 4 Class 1/1/1/1 DIGITAL

DIGITAL DIN 5/13 Adjustable

PANORAMIC			
APOLLO 5-9/9-13G	Fixed DIN 5	DIN 3 > 5/13 Adjustable	Fixed DIN 5
PANORAMIC 3XL	DIN 3 > 10	DIN 3 > 4/12 Adjustable	DIN 3 > 10

APOLLO 5-9/9-13 G TRUECOLOR
037809 94,13 €HT

100 x 67 mm 0.12 ms

GRIND + 4 PANORAMIC

PANORAMIC DIN 5/13 Adjustable

PANORAMIC 3XL TRUECOLOR
037281 297,14 €HT

114 x 85 mm 0.15 ms

GRIND + 4 Class 1/1/1/1 PANORAMIC

PANORAMIC DIN 4/12 Adjustable

TORCHES ASPIRANTES - Fume Extraction Torches

BINZEL

Acier/Inox - Steel/Stainless steel - Stahl/Edelstahl

AIR	150 A	250 A
	original equipment	M6
Ø	Ø0.8	Ø1.0
X % 40°C - ArCO ₂	150A - 60%	200A - 60%
GRIP	GRIP	GRIP
L	3 m	3 m
Ref.	043251 565 ⁷⁰ €HT	040540 648 ⁹⁰ €HT

ASPIRATEUR DE FUMÉE - Fume Extraction System

BINZEL

- 230V / 1 ~, 1100 W
- 200 m³/h max
- 190 mbar max
- 26 kg, 390 x 210 x 500 mm
- 71 db
- Système de nettoyage automatique du filtre - Filter auto cleaning system - Automatische Filterabreinigung

Automatic ON/OFF 043237 3389⁸¹ €HT
Manual 043244 2866⁸³ €HT

100 m³/h

ASPIRATEURS DE FUMÉE - Fume Extraction Systems - Rauchgasabsauggerät

UNI 2.0 RE

- 400V / 3 ~ / 50 Hz
- 1100 W
- 1300 m³/h max
- 3-4h/day
- arm 3 m
- no plug
- 100 kg
- extraction 0.5 m/s

061545 3660⁸⁰ €HT

Included Pré-filtre (treillis aluminium) - Pre-filter (aluminium mesh) Class G3 EN 779
+ Filtre - Filter Class H12 EN 779 Filtration > 99% 046467 532⁴¹ €HT

Option Flexible d'extraction 10 m Ø 150 mm 062139 94,13 €HT

EVO 2.1 RE

- 230V / 1 ~ / 50 Hz - 32A
- 1100 W
- 1200 m³/h max
- occasional
- arm 3 m
- included
- 85 kg

061552 3639⁸¹ €HT

Included Pré-filtre (treillis aluminium) - Pre-filter (aluminium mesh) Class G3 EN 779
+ Filtre - Filter Class H12 EN 779 Filtration > 99% 046467 532⁴¹ €HT

Option Flexible d'extraction 10 m Ø 150 mm 062139 94,13 €HT

Breveté - Patented

PROFI MASTER

- 1100 W
- 1100 m³/h
- 72 dB (A)
- arm 3m
- 104 Kg (with arm)
- 400V / 3 ~ / 50 Hz

067783

NEW

Pre-filter x1 067820
Main filter x1 067844

SMART MASTER

- 1100 W
- 950 m³/h
- 72 dB (A)
- occasional (1 sel N)
- arm 3m
- 81 kg (with arm)

230V / 1 ~ / 50 Hz included 067769
115V / 1 ~ / 60 Hz no plug 067776

NEW

Pre-filter x10 067790
Pre-filter x10 067806
Main filter x1 067813

VERRES - Lenses - Schutzgläser					TRUE COLOR	HF	DELAY								MASK BRAND	
114 x 133 (x10)	043893 7 ⁹⁷ €HT	106 x 89,5 (x10)	046825 8 ³² €HT	GYSMATIC XXL & 5/13 AIR XXL TRUECOLOR XXL	4-5>9/9>13	0.10 ms	✓	0.1 > 0.9 s	1/1/1/1	4 HIGH SENSITIVITY	XXL : 100x83 mm	✓	+2 (CR 2450)	Comfort Pro	680 g	Gys
114 x 133 (x10)	043893 7 ⁹⁷ €HT	103.7 x 69.5 (x5)	043695 3 ³³ €HT	APOLLO 5-9/9-13 G	4-5>9/9>13 + 2x:5	0.15 ms	—	0.15 > 0.8 s	1/1/1/2	4 HIGH SENSITIVITY	XXL : 100x67 + 2x103.7x69.5 mm	✓	+2 (CR 2450)	Multi	580 g	Gys
390 x 150 (x3)	037311 7 ⁹⁴ €HT	special kit (x5)	037304 9 ⁵¹ €HT	PANORAMIC 3XL TRUECOLOR	3-4>8/8>12 + 2x:3>10	0.15 ms	✓	0.15 > 0.8 s	1/1/1/1	4 HIGH SENSITIVITY	114x85 + 2x(68x80) mm	—	+2 (CR 2450)	Multi	610 g	Gys



INDUCTION HEATING

CAR BODY

PFC POWER FACTOR CORRECTION

185 V ↔ 265 V



055490 49€HT

GYSDUCTION AUTO

2400 W 230V • 1~

PFC AIR



included C20/B1 056862



COMBIDUCTION AUTO 50LG

5200 W 230V • 1~

PFC LIQUID

065901

3 m

COMING SOON



2 in 1

50LG



AUTO



INCLUDED COMBIDUCTION



Décapage - Glass - Entfernen 053373 295€HT



Protection (x5) + Colle - Stick 053854 52€HT



Décollage - Decal - Entkleben 053359 295€HT



Protection (x1) + Colle - Stick 059108 57€HT

OPTIONS

Inducteur spirale - Spiral inductor - Spiralinduktor 054783 68€HT



1.2 kW



2.5 m

Débosselage sans peinture - PDR : Paintless Dent Repair - Lackschadenfreies Ausbeulen 054776 338€HT

Licensed by BETAG innovation



3 m

Spray refroidisseur - Freezer spray



-50 °C 400 ml (x 12) 048898 148€HT

Adhesive for logo (x10) 051492 15€HT



PACKS - GYSDUCTION AUTO		PROLINER AUTO	COMPLETE AUTO	COMPLETE AUTO +	MECA AUTO	MECA AUTO +	BODY SHOP AUTO	GLASS AUTO	DENT REPAIR AUTO
1 box		048775 2117€HT	053380 1811€HT	056978 2497€HT	048812 1262€HT	056961 1948€HT	048799 1902€HT	048805 1285€HT	054981 1308€HT
GYSDUCTION AUTO	✓	✓	✓	✓	✓	✓	✓	✓	✓
Plastic wedges 054981 1308€HT	✓	✓	✓	-	-	✓	✓	-	-
Burn off inductor 053373 295€HT	✓	✓	✓	-	-	✓	✓	-	-
Body inductor 053359 295€HT	✓	✓	✓	-	-	✓	-	-	-
Bolt inductor 053366 242€HT	✓	✓	✓	✓	✓	-	-	-	-
Remote control 054490 49€HT	✓	✓	✓	✓	✓	✓	-	-	-
Universal 800 051331 226€HT	✓	-	-	-	-	-	-	-	-
Cable support 052284 80€HT	✓	-	-	-	-	-	-	-	-
Dent pulling inductor 054776 338€HT	-	-	-	-	-	✓	-	-	✓
Spiral inductor 054783 68€HT	-	-	✓	-	✓	-	-	-	-



CE NORM. EN-60335/1	MADE IN FRANCE	Cable L (m)	Freq. kHz	Tech. PFC	Liquid Cooling	Cable L (m)		Heating	cm	kg	Protected & compatible power generator (+/-15%)		
						Inductor	Inductor						
GYSDUCTION AUTO	230V, 1~ , 50/60 Hz	16 mini	2400	35+100	■	2	2.5	M10 → 1 s	2 mm → 5 s	Ø8 → 10 s	36 x 27 x 22	7.5	3 kW
COMBIDUCTION AUTO 50LG	230V, 1~ , 50/60 Hz	25 mini	5200	30+50	■ 71	8	3	M14 → 1 s	2 mm → 3 s 4 mm → 5 s	Ø10 → 10 s	59 x 88 x 59	72	6 kW



POWERDUCTION

INDUCTION HEATING

MAINTENANCE / MECHANIC / INDUSTRY

PFC POWER FACTOR CORRECTION

185V ↔ 265V

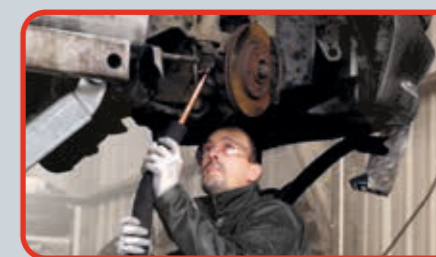
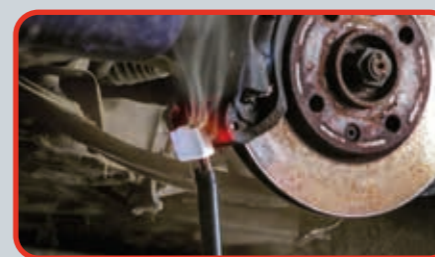

81

POWERDUCTION INDUCTION HEATING

INCLUDED

Spirale - Coil - Spiralförmiger draht

Ø 18 mm
054806 30€HT

Ø 24 mm
054790 33€HT

Ø 30 mm
055469 33€HT

Fil tressé enroulable - Flexible
wrappable wire - Flexibel
geflechtener draht

800 mm
054813 57€HT

Fil droit rigide - Straight rigid wire
- Steif gerade draht

800 mm
054868 31€HT



1 m

POWERDUCTION 10R

1 200 W 230V • 1~

AIR

062504 833,0 €HT



2 m

POWERDUCTION 37LG

3 700 W 230V • 1~

LIQUID

058692 2 941,0 €HT



3 m

POWERDUCTION 39LG

3 700 W 230V • 1~

PFC LIQUID

058583 3 599,0 €HT



3 m

POWERDUCTION 50LG

5 200 W 230V • 1~

PFC LIQUID

055599 4 340,0 €HT



4 m

POWERDUCTION 110LG

11 000 W 400V • 3~

LIQUID

058590 6 171,0 €HT



NEW

11 000 W 208-240V • 3~

LIQUID

065246 6 697,0 €HT

OPTION 10R

NEW

Decal - Décollage - Entkleben
066601 114€HT



OPTION 37LG



Cable support
052284
80€HT

Chariot - Trolley
UNIVERSAL 800
051331 226€HT



Youtube

EN-60 335/1	MADE IN FRANCE	Cable L (m)	Freq.	INTEGRATED TECHNOLOGY	Liquid Cooling	Inductor	Heating	cm	kg	Protected & compatible power generator (+/-15%)				
											A	W	kHz	P400
POWERDUCTION 10R	230V, 1~, 50/60 Hz	10 mini	1 200	45+80	—	—	2	1	M10 → 1 s	2 mm → 5 s	Ø8 → 10 s	23 x 14 x 10	3	1.5 kW
POWERDUCTION 37LG	230V, 1~, 50/60 Hz	16 mini	3 700	15+30	—	—	2	2	M10 → 1 s	2 mm → 5 s	Ø10 → 15 s	45 x 29 x 25	15	4 kW
POWERDUCTION 39LG	230V, 1~, 50/60 Hz	16 mini	3 700	30+50	■	■	2	3	M12 → 1 s	2 mm → 5 s	Ø10 → 15 s	53 x 70 x 37	39.5	4 kW
POWERDUCTION 50LG	230V, 1~, 50/60 Hz	25 mini	5 200	30+50	■	■	8	3	M14 → 1 s	2 mm → 3 s 4 mm → 5 s	Ø10 → 10 s	59 x 88 x 59	70	6 kW
POWERDUCTION 110LG 400V	400V, 3~, 50/60 Hz	16 mini	11 000	25+40	—	—	5	4	M18 → 1 s	2 mm → 2 s 4 mm → 4 s	Ø10 → 7 s	59 x 88 x 59	80	15 kW
POWERDUCTION 110LG 208-240V	208-240V, 3~, 50/60 Hz	35 mini	11 000	25+40	—	—	5	4	M18 → 1 s	2 mm → 2 s 4 mm → 4 s	Ø10 → 7 s	59 x 88 x 59	86	15 kW



POWERDUCTION - ACCESSORIES & CONSUMABLES



included adapter 32L + L90 064515 + 059788

COMING SOON

POWERDUCTION 160LG
16 000 W 400 V • 3~
 ❄️ LIQUID
 057814 7 977,0 €^{HT}

16 000 W 208-240 V • 3~
 ❄️ LIQUID
NEW
 065253

POWERDUCTION 220LG
22 000 W 400 V • 3~
 ❄️ LIQUID
 066861

OPTIONS



Housse de protection - Protection cover - Schutzhaube for POWERDUCTION 160LG 050853 206€^{HT}



Cooling liquid (not included) 5L 062511 41€^{HT} 10L 052246 72€^{HT}

Model	Voltage	Power	Freq.	Liquid Cooling	Cable L (m)	Heating			cm	kg	Protected & compatible power generator (+/-15%)
						Inductor	Inductor	Heating			
POWERDUCTION 160LG 400V	400V, 3~ 50/60 Hz	16 000	25+40	❄️ 301	6	M20 → 1s	2 mm → 2s 4 mm → 4s	Ø10 → 5s	70 x 118 x 60	120	22 kW
POWERDUCTION 160LG 208-240V	208-240V, 3~ 50/60 Hz	16 000	25+40	❄️ 301	6	M20 → 1s	2 mm → 2s 4 mm → 4s	Ø10 → 5s	70 x 118 x 60	130	22 kW
POWERDUCTION 220LG	400V, 3~ 50/60 Hz	22 000	25+40	❄️ 301	6	N/A	N/A	N/A	70 x 118 x 60	125	22 kW

t° POWER HEAT CONTROLLER



t° CONTROL
80>350°C

NEW

POWER HEAT CONTROLLER 061644 43€^{HT}

Included T° sensors thermocouple type K x2

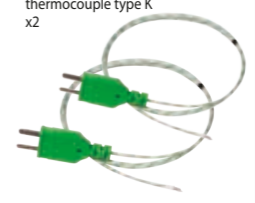

Youtube

OPTIONS



Pyrometer IR for inductor L90
1.1 m 064119 653€^{HT}



INDUCTEURS - Inductors

	SMALL (Ø16)							LARGE (Ø32)				
	S90	S70	S180	S20/B1 (20°)	S180/B1	S180/B2	S180/B3	L90 (90°)	L70 (70°)	L180	L180/Spiral	L20/B4
* = original equipment	058927 166€ ^{HT}	061569 189€ ^{HT}	059269 209€ ^{HT}	064874 297€ ^{HT}	064881 297€ ^{HT}	064928 297€ ^{HT}	067899	059788 277€ ^{HT}	059771 302€ ^{HT}	059795 338€ ^{HT}	065000 554€ ^{HT}	067882
37 LG	✓*			✓								
39 & 50 LG				with adapter 285						with adapter 28L		
110 & 160 LG				with adapter 32S				with adapter 32L*		with adapter 32L		
220 LG				with adapter 32S					with adapter 32L			with adapter 32L*

	28S	32S	28L	32L
	M28 Ø16 064485 127€ ^{HT}	M32 Ø16 064508 138€ ^{HT}	M28 Ø32 064492 174€ ^{HT}	M32 Ø32 064515 197€ ^{HT}
37 LG				
39 & 50 LG		✓		✓
110 & 160 LG		✓		✓
220 LG		✓		✓

COMPLETE (Ø28)

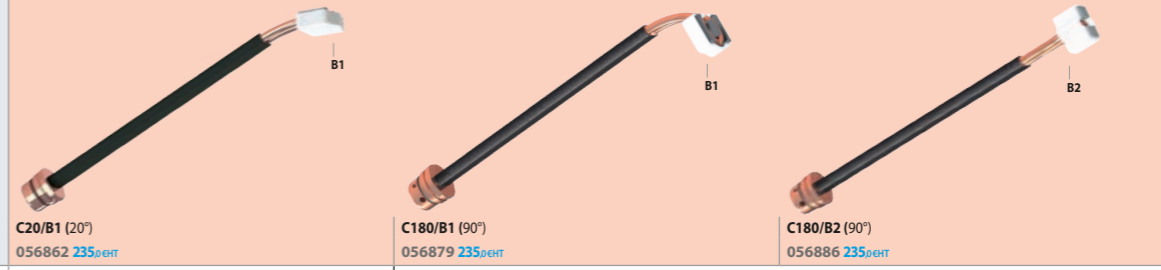

	C20/B1 (20°)	C180/B1 (90°)	C180/B2 (90°)
* = original equipment	056862 235€ ^{HT}	056879 235€ ^{HT}	056886 235€ ^{HT}
39 & 50 LG	✓*		✓

BOÎTES - Boxes



28S/B for 39LG & 50LG 065802 1023€^{HT}
 included: S20/B1 (x1) S180/B1 (x1) S180/B2 (x1) 28S (x1) B1 (x1) B2 (x1)



32S/B for 110LG & 160LG 065819 1036€^{HT}
 included: S20/B1 (x1) S180/B1 (x1) S180/B2 (x1) 32S (x1) B1 (x1) B2 (x1)



L box 065796 653€^{HT}
 included: L70 (x1) L180 (x1)

FERRITES - Ferrites - Ferritaufsatz



B1 053823 10€^{HT} B2 053823 10€^{HT} B3 067875 B4 053755 114€^{HT}
 B1 056909 19€^{HT} B2 056916 23€^{HT} B4 054844 62€^{HT}



Colle-Stick bi-composants Power Epoxy 150°C 054851 53€^{HT}

COFFRET DE DÉCOUPE PARE-BRISE
- Professional Box Set for Windscreen Removal - Frontscheiben-Trennsystem für Akkuschrauberbetrieb



057654 **1 001,0€**

included
65 m
058125 **118,0€HT**

included
Axe enrouleur
068100

MADE IN HIGH QUALITY GERMANY



COUPEAU PNEUMATIQUE DE DÉCOUPE PARE-BRISE
- Oscillating Pneumatic Saw for Windscreen Removal - Druckluft-Trennmesser für Windschutzscheiben

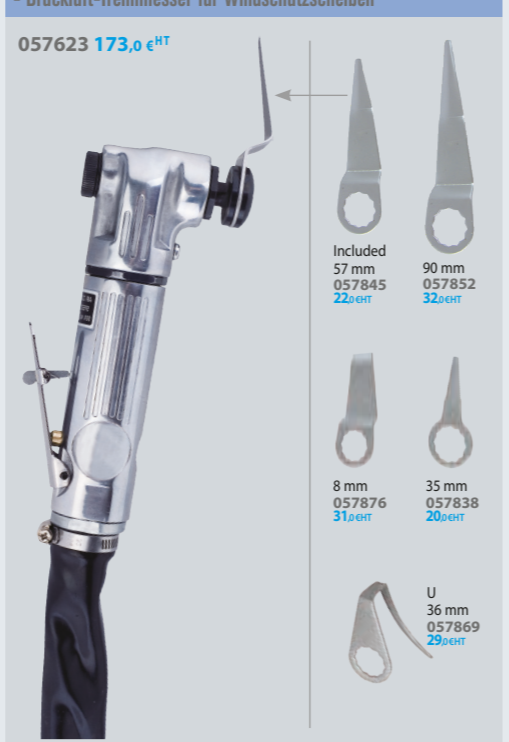

057623 **173,0€HT**

Included
57 mm
057845 **22,0€HT**

90 mm
057852 **32,0€HT**

8 mm
057876 **31,0€HT**

35 mm
057838 **20,0€HT**

U
36 mm
057869 **29,0€HT**

EXTRACTEUR D'ESSUIE-GLACE - Removal tool for wiper arms - Wischerarm-Abzieher



UNIVERSEL
057630 **39,0€HT**

EXPERT
Accès difficile
- Difficult access
057647 **109,0€HT**

30 mm max

40 mm max

SYSTÈME DE DÉCOUPE PARE-BRISE A CLIQUET
- Windshield Cutting kit - Set zum Lösen von Windschutzscheiben



054738 **485,0€HT**

PROTECTIONS TABLEAU DE BORD
- Dashboard Protector - Armaturenbrett Schutz



053120 **46,0€HT**

45 cm

27 cm

45 cm

27 cm

VENTOUSES - Suction Lifting Pads - Saugnapfwerkzeug für Spiegelgläser



056695 **17,0€HT**

Ø 70 mm

051966 **97,0€HT**

x2

x6
057609 **32,0€HT**

OUTIL DÉCOUPE PARE-BRISE
- Windshield Cutting Tool - Windschutzscheiben Demontage-Set



051935 **80,0€HT**

KIT DÉCOUPE JOINT DE PARE-BRISE - Windscreen Joint-cutting Kit - Scheibentrenn-Werkzeug-Set



051898 **274,0€HT**

051911 **11,0€HT**

051881 **33,0€HT**

Corde à piano torsadé (22 m)
- Windscreen seal cutting wire (twisted)
- Piano-Schneiddraht, gedreht, 22 m Rolle

Corde à piano carré (50m)
- Windscreen seal cutting wire (square)
- Vierkant-Draht, 50 m Rolle

RENOV'POLYCARBONATE - Compressed air polisher - Druckluftpolierer



Complete pack
1 ponceuse orbitale
+ 1 lustreuse
- 1 orbital sander
+ 1 polisher

052086 **379,0€HT**

2 SPEED

052055

052062

052079

sander Ø75
057494

polisher Ø75
058224

Ø 76

P 500 (x 10)
P 800 (x 10)
P 1500 (x 10)
P 3000 (x 10)

P 500 x 50 052017 **34,0€HT**
P 800 x 50 052024 **46,0€HT**
P 1500 x 50 052031 **34,0€HT**
P 3000 x 50 052048 **43,0€HT**

AGRAFEUSE POUR RÉPARATION PARE-CHOCS - Hot stapler for bumper repair - Stoßstangen Reparatur Kit

052925 203,0 €HT



INCLUDED:
x20 x20 x20 x20 x20

MADE IN TAIWAN

PORTABLE
Sur batterie - Battery operated
058118 439,0 €HT

included
Li-ion battery 3.7 V
048669
included adapters:
EUR, UK, USA & AUS

Charger included
048652 40,0 €HT

MADE IN TAIWAN



INCLUDED:
Ø 0,6, x100 Ø 0,8, x100
Ø 0,6, x100

Agrafes - staples	V	U	N	W	M
	Angle interne étroit - Inside corner Ø 0.7 mm	Alignement de fissure - Crack alignment Ø 0.7 mm	Fissure importante - Large crack Ø 0.7 mm	Angle interne - Internal angle Ø 0.7 mm	Angle externe - External angle Ø 0.7 mm
	x 100 047990 19,0 €HT	x 100 047983 19,0 €HT	x 100 047976 19,0 €HT	x 100 047969 21,0 €HT	x 100 047952 21,0 €HT
052413 72,0 €HT	= x 50	+ x 50	+ x 50	+ x 50	+ x 50

COFFRET DE PERÇAGE PARE-CHOCS POUR DÉTECTEURS - Piercing Kit for Bumper Sensors - Lochwerkzeug für Stoßfänger



PRO +
059139 141,0 €HT

Ø 17-18-18,2
19-20-22,5-24
26-26,7-32 mm



FREEZER

Spray refroidisseur
- Freezer spray

-50 °C
400 ml

(x 12)
048898 148,0 €HT

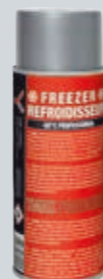

COFFRET DE RÉPARATION DES PLASTIQUES AUTOMOBILES - Brazing automotive plastics repair kit - Kunststoff Reparatur Set

052932 159,0 €HT

MADE IN BELGIUM

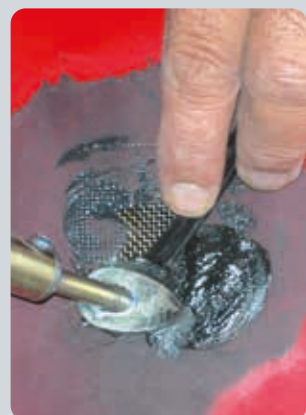

x10
052956

25 x 12,5 cm
x2
052949

STATION DE SOUDAGE DES PLASTIQUES - Plastic welding station - Kunststoff-Schweißset

320 W - 230 V, 1-50 Hz
Temperature: 160 - 480°C
3.4 kg
Length of hose: 1 m
Air flow: 24 l/min

062726 417,0 €HT



Ø 5 mm included
066694
Ø 8 mm included
066700

Station seule - Station only
064072 168,0 €HT

INCLUDED	440 mm	PP / EPDM	4 mm x 10	054172 54,0 €HT
			6 mm x 10 <td>054172 54,0 €HT</td>	054172 54,0 €HT
			8 mm x 10 <td>066298 11,0 €HT</td>	066298 11,0 €HT
OPTION	440 mm	PP / EPDM	5 mm x 10	063242 11,0 €HT
			10 mm x 10 <th>063259 11,0 €HT</th>	063259 11,0 €HT
		ABS	5 mm x 10	063372 11,0 €HT
			10 mm x 10	063266 14,0 €HT

OPTION

Trolley SPOT 600
053533 130,0 €HT



NEW

Grattoir
- Scraper
068032

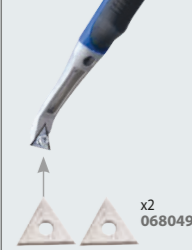

Included
058231 25,0 €HT



Included
Mini fraiseuse - Mini milling machine
063228 59,0 €HT

Included
Tungsten drill Ø 5 mm
063235 59,0 €HT

KIT DE SOUDAGE DES PLASTIQUES - Welding Kit for Plastics - Kunststoff-Schweißset



1 600 W - 230V - 50/60 Hz
max. 230 l/min
1.3 kg / -L- Ø100 x 300mm,
poignée Ø 56mm.

057678 739,0 €HT

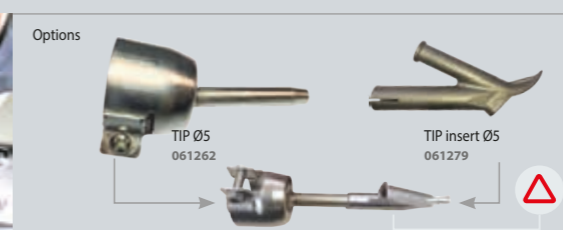
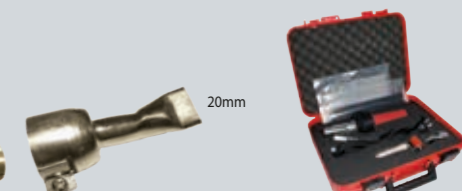

Options

TIP Ø5
061262

TIP insert Ø5
061279

x10
052956

x1
25 x 12,5 cm
052949

STATION DE SOUDAGE À ULTRASONS DES PLASTIQUES

- Ultrasonic welder - Ultraschall-Kunststoffschweißgerät



230 V
Output 40 kHz - 800 W
29 x 22 x 12 cm
3 kg
0.8 kg (gun)

067868

MADE IN ITALY



NEW

Touch screen
6 languages
Timer control

included
2 Titanium sonotrodes



GYS HAND TOOLS - Ausbeulwerkzeug

● **FULL PACK =**
061637 **1 145,0 €HT**

● **MEDIUM PACK**
051133 **643,0 €HT**

MADE IN HIGH QUALITY GERMANY

053311 72,0€HT
053298 72,0€HT
061309 65,0€HT
053335 76,0€HT
053342 60,0€HT
053328 91,0€HT
053281 67,0€HT

051430 49,0€HT
051416 65,0€HT
051454 60,0€HT
051447 33,0€HT
051409 98,0€HT

070 kg 051485 87,0€HT
095 kg 051478 85,0€HT
133 kg 051461 94,0€HT

051423 72,0€HT
062351 49,0€HT (9 dents/pouce - 9 teeth/inch)
062368 52,0€HT (15 dents/pouce - 15 teeth/inch)

KIT MARTEAUX ET TAS - Planishing Kit for Car Body (Set of 3 Hammers + 4 Dollys) - Karosseriehammer & Handfaust Kit

057579 **213,0 €HT**

40 x 40 mm
70 x 90 mm
1.4 kg
061408 **32,0 €HT**

117 x 57 mm
1.2 kg
061415 **26,0 €HT**

117 x 57 mm
1.2 kg
061422 **28,0 €HT**

OUTILS DE DÉGARNISSAGE ET RACLAGE - Set of 30 Tools for scraping/sanding and paint removal - Polster & Schaber Kit

057616 **92,0 €HT**

BURINS - Hand Chisel for Car Body - Meißel für Karosserie

26 x 7 mm
057586 **29,0 €HT**

60 x 11 mm
057593 **31,0 €HT**

COUTEAUX RACLOIRS

061439 **24,0 €HT**

15 mm
20 mm
30 mm

OUTILS DE FORME - Forming tools - Formgebungswerkzeuge

051195 **109,0 €HT**

180 x 70 x 65 mm
280 x 95 mm
75 x 65 mm

JEU DE 4 BURINS EN NYLON - Set of 4 nylon chisels - 4 Kunststoffmeißel

054745 **18,0 €HT**

273 mm

19 mm (x1)
22 mm (x1)
25 mm (x1)
38 mm (x1)

JAUGES DE PROFIL - Contour Gauge - Konturenlehre

052840 **15,0 €HT**
057265 **57,0 €HT**

250 mm
500 mm

JAUGES DE POSITIONNEMENT - Gapping gauges - Spaltmaßlehre

x2
054752 **40,0€HT**

OUTIL DE REMISE EN FORME PASSAGE DE ROUE - Fender roller tool set

060791 **99,0 €HT**

REDRESSEUR DE CHARNIÈRE DE PORTE - Fixed Hinge Bending Tool

051102 **290,0 €HT**

Redresseur de charnière de porte
- Door hinge straightener
- Türgelenkausrichter

40 mm max

PINCES DE MAINTIEN BORD À BORD - Positioning clamp - I-Stoß-Lehre

(x4)
043190 **36,0 €HT**

PINCES MICRO-GRIP - Micro-grip clamps

(x4)
061330 **102,0 €HT**

20 mm max
95 mm

PINCES ÉTAU À BEC PLAT - Flat noze lock-grip pliers

062719 **53,0 €HT**

250 mm
100
max 25
75
max 20
200 mm

PINCES AXIALES - Axial-grip pliers

050242 **144,0 €HT**

Type I Type J Type JJ Type W Type LL Type G

280 mm 061378 **122,0€HT**
x6
80 mm

610 mm 061354 **95,0€HT**
x2
410 mm

460 mm 061361 **145,0€HT**
x4
240 mm

Flat noze - 610 mm 061347 **99,0€HT**
x2
410 mm

PINCES ÉTAU MONO SERRAGE - Lock-grip pliers

Flat noze - 460 mm 050112 **99,0€HT**
x6
240 mm

KIT: 050266 **125,0€HT**
x3
Flat noze 280 mm

x3
x5
x5
= 16

MINI-MEULEUSE - Mini disc sander - Druckluftschleifer

051829 **164,0 €HT**

Speed adjustment

Ø 75 mm

Speed rpm	Power W	dB	Air consumption l/min	Air pressure bar	cm	kg
18000	200	83	171	6.2	12	0.7

Included (x1) 052468 **27 €HT**

058248 **168,0 €HT**

x2 Ø
Ø 50 & 75 mm

Speed rpm	Power W	dB	Air consumption l/min	Air pressure bar	cm	kg
15000	84	91	6.2	10	0.6	

MINI-FLEXIDISC LAMELLES ZIRCON Ø 50 mm

- K 40 (x10) 058255 **83 €HT**
- K 60 (x10) 058262 **83 €HT**
- K 80 (x10) 058279 **84 €HT**

PONCEUSE À BANDE À TÊTE ORIENTABLE - Air belt sander - Druckluft Bandschleifer

060906 **189,0 €HT**

520 mm

360°

20 mm

- Grain 60 (x 5) 060913 **30 €HT**
- Grain 80 (x 5) 060920 **30 €HT**
- Grain 100 (x 5) 060937 **30 €HT**
- Grain 36 céramique (x 5) 062535 **67 €HT**

Speed rpm	Air consumption l/min	Air pressure bar	cm	kg
16 000	171	6.3	34	1.2

PONCEUSE À BANDE À TÊTE ORIENTABLE - Air belt sander - Druckluft Bandschleifer

052819 **109,0 €HT**

360°

330 mm

10 mm

- Grain 80 (x 10) 052833 **44 €HT**
- Grain 36 céramique (x 20) 062528 **58 €HT**

Speed rpm	Air consumption l/min	Air pressure bar	cm	kg
16000	171	6.3	26	0.9

MINI-FRAISEUSE À RENVOI D'ANGLE - Mini Angle Milling Machine - Mini-Winkelschleifer

051836 **90,0 €HT**

90°

Speed rpm	Power W	dB	Air consumption l/min	Air pressure bar	cm	kg
18000	500	81	85	6.2	18	0.7

PERCEUSE MANDRIN AUTOMATIQUE - Automatic Mandrel Drill - Druckluftbohrmaschine m. Schnellspannfutter

051799 **106,0 €HT**

Ø 13

Speed rpm	Power W	dB	Air consumption l/min	Air pressure bar	cm	kg
800	300	92	170	6.2	18	0.9

MEULEUSE D'ANGLE - Long Handled Angle Grinder - Druckluft-Winkelschleifer

057753 **245,0 €HT**

Ø 100 mm

- ± 1.6 mm, x5 057883 **23 €HT**
- ± 0.8 mm, x5 058217 **22 €HT**

Speed rpm	Power W	dB	Air consumption l/min	Air pressure bar	cm	kg
14000	84	113	6.2	37	1.7	

MINI-MEULEUSE À RENVOI D'ANGLE - Mini Angle Grinder - Mini-Druckluftwinkelschleifer geräuschgedämpft

051867 **88,0 €HT**

Ø 50 mm

90°

(x1) 052772

Speed rpm	Power W	dB	Air consumption l/min	Air pressure bar	cm	kg
15000	200	86	85	6.2	18	0.75

SCIE COUPE TÔLE DROITE ET LIME - Saw for Straight Cut and File - Druckluftsäge und Feile

051805 **148,0 €HT**

(x5) 052789 **10 €HT**

included 058750 **39 €HT**

Speed rpm	Power W	dB	Air consumption l/min	Air pressure bar	cm	kg
5000	—	85	255	6.2	10	0.8

COFFRET DÉCAPEUSE PNEUMATIQUE - Pneumatic surface remover Kit - Druckluftentroster-Box inkl. Zubehör

051775 **376,0 €HT**

- Roue gomme 115 x 14 mm 051874 **20 €HT**
- Roue à décapier 115 x 14 mm 051843 **20 €HT**
- Adaptateur pour brosse 051768 **20 €HT**
- Brosse souple Brins droits 0.5 mm 103 x 23 mm 052598 **28 €HT**
- Brosse dure Brins incurvés 0.7 mm 103 x 23 mm 051812 **28 €HT**
- Brosse souple Brins incurvés 0.5 mm 103 x 23 mm 051850 **29 €HT**

Speed rpm	Power W	dB	Air consumption l/min	Air pressure bar	cm	kg
4000	500	86	102	6.2	280	1.2

MINI FRAISEUSE - Mini milling machine - Mini-Schleifer

063228 **59,0 €HT**

NEW

Option

Tungsten drill Ø 6 mm 054172 **54 €HT**

POINÇONNEUSE PNEUMATIQUE OBLONG - Pneumatic oval punching tool - Pneumatische Langloch-Blechzange

053182 **333,0 €HT**

for MIG brazing

6 mm 20 mm
1.2 mm max

included 6x20 53515

DÉPOINTEUSE POUR CORDON LASER ACIER - Laser cord metal sheet cutter (nibbler) - Trennwerkzeug für Lasernähte

054165 **294,0 €HT**

Ø 6 mm

STEEL Included 054172 **54 €HT**

Outil de poinçonnage oblongs - Punching tool for oval holes - Langlochkarosserieblechzange

052437 **526,0 €HT**

067264

2.2 kg

6 mm 20 mm
8 mm 20 mm

PINCE À SOYER ET À TROUER, Ø5MM PNEUMATIQUE - Pneumatic flange / ø5 mm punching tool - Pneumatische Loch- und Absatzzange Ø 5 mm

052543 **82,0 €HT**

2 in 1

Ø 5 mm

0,8 > 1,2 mm

0,8 > 1,2 mm

BODY ZIPPER - Sertisseuse pneumatique Pneumatic Crimper - Druckluftkantenformer

056930 **778,0 €HT**

MADE IN HIGH QUALITY POLAND

- MINI
- initial W
- final M x < 2.4mm
- final D x > 2.4mm

total thickness x=2a+b

Air pressure bar	cm	kg
5	28	2.1

DÉPOINTEUSE - Spot remover - Druckluft-Schweißpunktbohrer

SPOT DRILL

050464 **422,0 €HT**

360°

Ø 8

Included: Tungsten Carbide Ø 8 for BORON/UHSS (x1)

HIGH QUALITY

Forets de dépointage - Spot remover drill - Schweißpunktfräse Tungsten Carbide for BORON/UHSS

Speed rpm	Power W	dB	Air consumption l/min	Air pressure bar	cm	kg
800	400	85	140	6.5	35	2.3

PACK SPOT DRILL + 140 mm

061460 **487,0 €HT**

140 mm 061453 **65 €HT**

3-edge Ø 8 mm 053069 **58 €HT**



TOURNEVIS SANS FIL - Cordless Mini Screwdriver - Akkuschrauber



DÉTECTEUR ÉPAISSEUR DE PEINTURE - Film coating thickness gauge



TOURNEVIS À CHOCS SANS FIL - Cordless Impact Screwdriver - Akkuschrauber



PONÇEUSE / POLISSEUSE ÉLECTRIQUE - Electric Sander & Polisher - Elektro-Polier-Schleifer



ASPIRATEUR PNEUMATIQUE POUR POUSSIÈRES ALU (ATEX) - Pneumatic aluminium dust atex vacuum cleaner



TIG AC/DC

GTAW AC/DC
RÉPARATION DE JANTES



200 A 110 → 230V • 1~

P400	PFC	FV	SR	VRD inside	TIG PULSE
L/DB/P	AD	MMA PULSE			

220 A 110 → 230V • 1~

P400	PFC	FV	SR	TIG PULSE	WAVE FORMS
CONNECT 5	ARC ON	L/DB/P	MMA PULSE	IP 23	

Métaux d'apport TIG - TIG filler rods - WIG-Schweißstäbe

5 kg (L = 1 m)	X...	
Alu - Aluminium - Aluminio (AIMg5)	Ø 1.6	920 087170 98 ^{ert}
Normes - Norms - Normen - Norma	Ø 2.0	590 087187 96 ^{ert}
EN ISO 18273 : 5 Al 5356	Ø 2.4	410 087194 92 ^{ert}

Électrodes tungstène - Tungsten electrodes - Wolfram Elektroden

WP PUR (AC)	Alu - Aluminium - Aluminio	
Ø 2.0	x10	046719 31 ^{ert}
Ø 2.4	x10	044579 38 ^{ert}

SR 17 - SR 18 - SR 26

AC/DC 044678 16^{ert}
Back cap (short+long) Tungsten electrode WR2 Ø 1.6 & Ø 2.4 + collets Gas nozzle N5 - N7

COMPLETE PACKS

pack	Welder	Accessories	Price
pack PROTIG 201 AC/DC	065710	SR26 DB, 4m 038271	2 051,00 €HT
pack TIG 220 AC/DC	028388	SR26 DB, 4m 038271	3 545,51 €HT

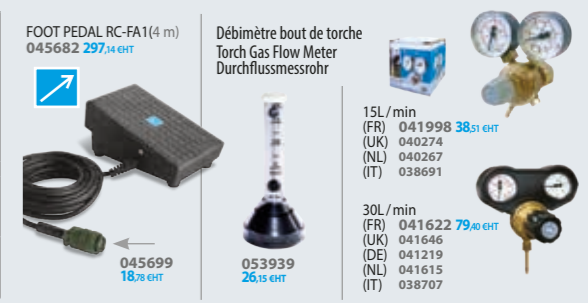

CE NORM EN60974-1	MADE IN FRANCE	I ₂ TIG A	INTEGRATED TECHNOLOGY										TIG		MMA		Freq. AC	U _o	mm ²	cm	kg	Protected & compatible power generator (+/-15%)	
			50/60Hz	A	AC	DC	P400	PFC	FV	SR	AID	TIG PULSE	WAVE FORMS	IP23	AD	I (60%)							X% (I2 max)
PROTIG 201 AC/DC-HF FV			110V-1~	20	10→160	10→160	■	■	■	■	■	■	■	■	■	■	■	■	■	■	■	■	7.5 kW
			230V-1~	13	10→200	10→160																	
TIG 220 AC/DC-HF FV			110V-1~	32	10→140	5→140	■	■	■	■	■	■	■	■	■	■	■	■	■	■	■	■	8.5 kW
			230V-1~	16	10→220	5→220																	

LAMPES BALADEUSES - Hand lamps - Handleuchte

Lampe BALADEUSE TRIPODE 250 L
100-250 lumens (x3)

3 x 1 W COB LED
3 x 3.6 V - 300 mAh
AAA rechargeable, Ni-MH
USB charging (6h)
operating time
High position: 1 h
Low position: 3 h
Flashing: 5 h



Lampe BALADEUSE PRO 600 L
250-600 lumens

COB LED, 80 CRI
3.7 V - 2200 mAh Li-ion
micro USB charging (3.5 h)
operating time:
High position: 1.5 h,
Mid position: 4.5 h,
Top light (100 lumens): 10 h



Lampe BALADEUSE 400 L
400 lumens

COB LED
Li-ion
Charging time: 8h
operating time
High position: 2.5 h
Low position: 5 h
Top light (1 W): 6 h

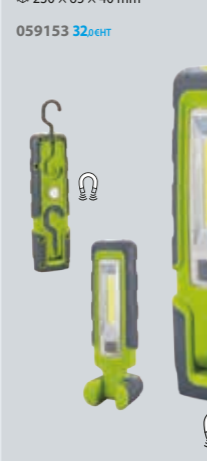

Lampe BALADEUSE ÉTANCHE 400 L
200-400 lumens

COB LED
3.7 V - 2000 mAh Li-ion
USB charging (4/6 h)
mains charger not included
operating time
High position: 2 h
Mid position: 4 h
Top light (4 W): 3 h



Lampe AMBIANCE 360° PORTABLE 1000 L
60-1000 lumens

>80 CRI SMD LED
6500 K
3.7 V - 5200 mAh Li-ion
USB charging (4.5h)
USB power supply
operating time 2 > 27 h



LAMPES SOUS CAPOT - Under bonnet lamps - Leuchte für Motorhaube

Lampe SOUS CAPOT 600 L
300-600 lumens

120 COB LED
3.7 V - 4000 mAh Li-ion
charging time: 10/12 h

operating time
High position: 1.5 h
Low position: 3 h



Lampe SOUS CAPOT 800 L
250-800 lumens

120 COB LED
3.7 V - 4000 mAh Li-ion
charging time: 10/12 h

operating time
High position: 3 h
Low position: 6 h

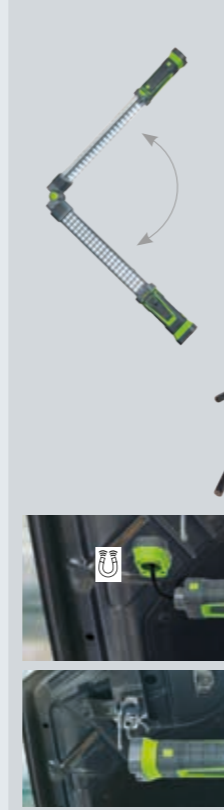

PROJECTEURS LED SUR TRÉPIED - LED worklights with tripod - LED-Arbeitsleuchte mit Standfuß

Lampe sur TRÉPIED 1600 L
800-1600 lumens

Li-ion
Charging time: 3/4 h

operating time
Floodlight: 3 h
Torch: 4 h
Side light of the torch: 12 h
3 modes together—2 h

IP 44

060890 85eur

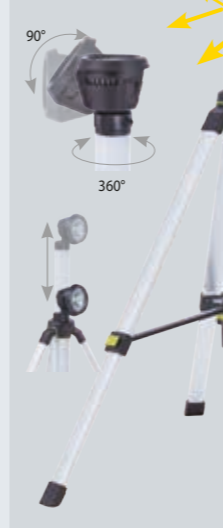

Lampe sur TRÉPIED 1800 L
1800 lumens

3x 55 COB LED
total 165 LED

1.8 m power cord

059146 77eur

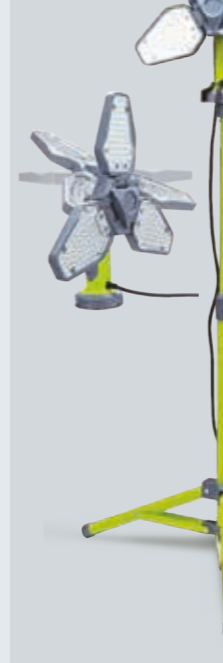

Lampe sur TRÉPIED 3000 L
3000 lumens

35 W COB LED

2 m power cord

IP 44

059979 79eur



Lampe sur TRÉPIED 4000 L
4000 lumens

3x 20 COB LED,
total 60 LED

3 m power cord

059986 112eur

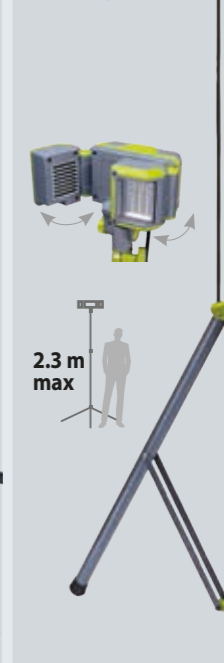

CONTRÔLE DES COULEURS - Detailing & colour match - Fabnpassung & Aufbereitung

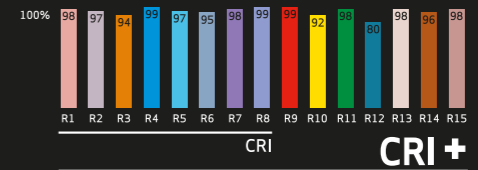

4500 K
400 lumens

SUNCOLOR 1
COB LED, CRI > 95, 1100 lux

3.7 V - 2600 mAh Li-ion
USB charging
operating time: 4.5 h
190 x 56 x 29 mm
290 g
IP 65

058477 61eur



3 COLORS
2700 - 4500 - 6500 K

350-420-450 lumens

SUNCOLOR 3
COB LED, 96 CRI+

3.7 V - 2600 mAh Li-ion
micro USB charging (4 h)
operating time: 2.5/4 h
IP 65

190 x 56 x 29 mm, 290 g

060838 95eur



5 COLORS
2700 - 3500 - 4500 - 5500 - 6500 K

500-1000-2000 lumens

SUNCOLOR 5
COB LED, 96 CRI+

11.1 V - 4400 mAh Li-ion
charger 110/240 V, 5 m cable, 15 V, 1.5 A
charging time: 3.5 h

operating time
High position: 2 h, Mid: 4 h, Low: 8 h

IP 65

225 x 200 x 70 mm, 1.2 kg

060876 172eur



5 COLORS
2500-3500-4500-5500-6500 K

250-500 lumens

SUNMATCH 3
COB LED, 96 CRI+, 700-1400 lux

3.7 V - 2600 mAh Li-ion, USB charging
operating time:
High position: 2 h, Low position: 4 h
IP 65

204 x 89 x 81 mm, 270 g

061651 170eur



SÉCHAGE UV - UV CURING

UV LED λ 395-400 nm

Irradiance 6-15 mW/cm²

NOVA-UV S

3.7 V - 5400 mAh Li-ion
USB charger, 1 m cable, 5 V, 2 A
charging time: 3.5 h
curing area: Ø 20 cm
operating time 1.5 h
IP 67

163 x 63 x 163 mm

061620 500eur

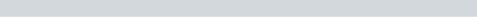

LAMPES D'INSPECTION - Inspection lamps - Inspektionslampen

Lampe INSPECTION FRONTALE 280 L
100-280 lumens

3 W COB LED, 80 CRI+, 6500 K
3.7 V - 1500 mAh Li-po
micro USB charging
mains charger not incl.
operating time
High position: 2 h
Low position: 6 h
IP 65

110 g, 78.5 x 47.5 x 42 mm

060845 36eur

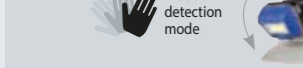

Lampe INSPECTION MINI 200 L
120-200 lumens

COB LED, 80 CRI, 6500 K
3.7 V - 700 mAh Li-ion
micro USB charging (2.5 h)
mains charger not included
operating time
High position: 1.5 h
Low position: 4 h
Top light: 3.5 h
IP 20

76 g, 174 x 27.5 x 28 mm

060852 30eur



Lampe INSPECTION FLEXIBLE 500 L
50-500 lumens

COB LED
80 CRI+
6500 K
3.7 V - 2600 mAh Li-ion
USB charging (4 h)
operating time
High position: 2 h
Low position: 16 h
Top light: 9.5 h

IP 54
290 g
423 x 65.5 x 44.5 mm

060869 56eur



Lampe INSPECTION PRO 600 L
0-600 lumens

COB LED
6500 K
3.7 V - 2600 mAh Li-ion
operating time
1.5 > 15 h

380 x 40 x 45 mm
300 g

057760 54eur
058309





TRÉTEAUX - Frames support - Klappböcke

040601 **48€HT**
100.5 x 112 cm - 5.5 kg
35 x 95 x 106 cm

Ø 28 mm

4 pieds coudés
Idéal sur caillbotis
- Bent feet for grating
- Abgewinkelte Standfüße:
Sicherer Stand auf Gittern u.ä.

040311 **88€HT**
104.5 x 117 cm - 8.1 kg
32 x 10 x 106 cm

4 ventouses
Dépose vitrages
- Suction pad for glazing
- Gummiteiler zur Fixierung
von Glasscheiben

Ø 32 mm

040250 **51€HT**
100 x 105 cm - 7kg
32 x 10 x 106 cm

Ø 32 mm

040304 **75€HT**
104.5 x 108.8 cm - 8.1 kg
32 x 10 x 106 cm

Léger et très maniable
Spécial travaux à l'horizontal
- Light and easy to handle
Ideal for horizontal works
- Speziell geeignet für Arbeiten
in horizontaler Position

Ø 32 mm

18.5 > 132 cm

24 kg

81 > 133 cm

059818 **480€HT**

86 cm

MADE IN HIGH QUALITY POLAND

Chaînette réglable
- Adjustable catenary

Mousse de protection
- Protecting foam

Antidérapants
- Non-slip base

**SUPPORT PARE-CHOCS - Rotary element support
Lackierständer für Stoßstange, einstellbar**

052376 **86€HT**
91 x 105 cm - 7.6 kg
60 x 11 x 75 cm

Adapté aux coques de rétroviseurs
- Adapted to wing mirror covers
- Geeignet für Außenspiegel

059825 **191€HT**

50 cm

106 x 104 x 215 cm - 32.5 kg
112 x 31.5 x 21.5 cm
+ 12 x 9.5 x 194.5 cm

059832 **77€HT**

50 cm

50 x 150 cm - 13 kg
152 x 15.5 x 11.5 cm

**SUPPORT ÉLÉMENT ROTATIF - Rotary element support -
Lackierständer für Stoßstange, einstellbar**

1.5 mm

360°

2 mm

052611 **180€HT**
200 x 101 cm - 17.5 kg
35 x 15 x 110 cm
Made in China

PRO
056725 **267€HT**
200 x 105 x 81 cm - 22 kg
24 x 17 x 118 cm

Verrouillage de l'axe - Locking of the axis
- Verriegelung der Achse

MADE IN HIGH QUALITY POLAND

**CHARIOT EXTENSIBLE POUR ÉLÉMENTS DE CARROSSERIE -
Extendable support - Ausziehbarer Wagen**

061507 **549€HT**
max 150 kg

100 cm

135 - 210 cm

26 kg
114.5 x 42 x 13.5 cm

MADE IN HIGH QUALITY POLAND

**CHARIOT DE LUXE MAROUFLAGE - Premium masking machine -
Abdeckpapier-Ständer**

MADE IN HIGH QUALITY POLAND

x 5

rouleaux de papier
- Papierständer
- Paper roll

30 > 120 cm

057333 **401€HT**
150 x 133 x 62 cm
32 kg
152 x 17 x 29 cm

Ø 40 mm
x 6
058897
42€HT

**CHARIOT DE MAROUFLAGE - Masking machine -
Abdeckpapier-Ständer**

MADE IN HIGH QUALITY POLAND

x 3

rouleaux de papier
- Papierständer
- Paper roll

30, 60, 90 cm

056954 **254€HT**
150 x 62 x 110 cm
- 12 kg
122 x 29 x 17 cm

**CHARIOT DE STOCKAGE - Storage trolley -
Lagerrollwagen**

040243
378€HT

71 x 90
x 197cm
41 kg
x2:
90 x 6 x 147 cm
+ 97 x 74 x 24 cm

TIGES DE BLOCAGE - Flap Lock

056732 **68€HT**

36 > 115 cm

**TABOURET - Round Stool with Tool Storage -
Werkstatt-Rollhocker**

057555 **72€HT**
38 x 38 x 44 cm - 6 kg
40 x 40 x 18 cm

max : 50 cm
min : 38 cm

SERVANTE 3 PLATEAUX - Workstation 3 shelves

068056

835 mm

390 mm

800 mm

NEW

**CHARIOT DE VISITE - Mechanics Creeper With
Tilting Headrest - Werkstatt-Rollliege**

057548 **62€HT**
102 x 43 x 11 cm
7.2 kg
11 x 44 x 13 cm

**MARCHE PIED - Folding Step Stool
(Aluminium) - Arbeitspodest klappbar**

ALU 200 kg

057562 **116€HT**
8.2 kg
102 x 41 x 59 cm

960 mm

385 mm

475 mm

**CHARIOT POUR ÉLÉMENTS DE CARROSSERIE -
Universal support - Universelle Ständer**

066281 **401€HT**
20 kg

max 80 kg

Ø 4.5 mm

NEW

80 cm

Ø 12.5

70-100 cm

115 cm

MADE IN HIGH QUALITY POLAND

ALU 150 kg

1090 > 1750 mm

520 > 900 mm

300 mm

058552 **312€HT**
15.5 kg

116 x 43 x 17 cm - 16.5 kg

COUVERTURE ANTI-CHALEUR - Heat cover - Hitzeschutzdecke - Manta anti-calor - Protecção anti-aquecimento

PROTEC 550
550°C/1000°F - Class M0
2m x 2m - 580 g/m²
050495 **68,95 € HT**

PROTEC 1200
1200°C/2200°F - Class M0
1,75m x 1,5m - 1200 g/m²
050204 **154,25 € HT**

PROTEC 1300
1300°C/2400°F - Class M0
XL: 2m x 1,8m - 620 g/m²
053595 **159,95 € HT**

PROTEC 1300L
1300°C/2400°F
XL: 2m x 1,8m - 427 g/m²
060500 **142,55 € HT**

JEU DE 2 AIMANTS
- Set of 2 magnets -
Schweißmagnet

(x2)
052291 **39,25 € HT**

COUVERTURE MAGNÉTIQUE - Magnetic cover - Magnetschutzdecke

1,06 m x 0,6 m
061446 **36,65 € HT**

RIDEAU DE SOUDAGE - Welding curtain and frame - Schweißerschutzwand

OPTI 215.0
Orange CE - 2 x 2,15 m
EN 25980 - 2015/01
060470 **325,95 € HT**

OPTI 200G
Green T9 - 2 x 2 m
EN 25980 - 2015/01
060463 **156,95 € HT**

MASQUES RESPIRATOIRES - Respiratory masks - Atemschutzmaske - Máscaras respiratorias

FFP3 - EN 140 / EN 143 / EN 166
(x1) Size M/L
037021 **99,95 € HT**

FFP3 - EN 140 / EN 143
(x1) Size M/L
037014 **46,12 € HT**

Étui / Case
037045 **17,12 € HT**

FFP3 - EN 143 : 2000 P3
Anti poussières / Anti odeurs
037038 **19,95 € HT**

FFP1 (x20) EN 149-2001
043916 **37,95 € HT**

FFP2D-OV
M/L (x5) EN 149-2001
043923 **33,95 € HT**

LUNETTES DE PROTECTION
- Protection goggles - Schutzbrillen

EN 166

Shade/IR0
042810 **6,18 € HT**

Shade/IR0
042827 **5,07 € HT**

Shade/IR5
042841 **27,18 € HT**

Shade/IR0
047778 **19,25 € HT**

Shade/IR0
047792 **17,95 € HT**

Shade/IR0
042865 **24,95 € HT**

Shade/IR0
047839 **25,20 € HT**

GANTS - Gloves - Handschuhe - Guantes

Anti coupe - Anti-cut
T9
045897 **10,95 € HT**

écran tactile - touch screen friendly
Anti coupe haute résistance
High resistance anti-cut
EN 420
EN 388:4121
T9: 045910 **40,95 € HT**
T10: 045927 **40,95 € HT**

Anti coupe haute dextérité - High dexterity anti-cut
EN 420
EN 388:1121
T9: 045903 **38,75 € HT**
T10: 045934 **38,75 € HT**

T10
064188 **13,95 € HT**

EN420 2003

Ultra Flexible
EN388 2003

EN388 4342

EN388 4244

EN 407 424X4X EN12477 Class: A1

Heavy Duty T10 (MMA - MIG - Plasma)
045101 **8,95 € HT**

EN388 2122

EN 407 322X2X EN12477 Class: A1

Gants PRO TIG T10
045194 **10,46 € HT**

EN388 2111XX

EN 407 423X4X EN12477 Class: A1

Gants de soudage renforcés - Reinforced welding gloves
T10
045873 **10,22 € HT**

EN388 4244

EN 407 424X4X EN12477 Class: A1

Gants PRO TIG EXTRA T10
045323 **13,95 € HT**

EN 407 423X4X EN12477 Class: A1

TABLIER CUIR MULTI-USAGE
- Multi-use leather apron - Delantal de cuero multi-uso - Mehrzweck-Lederschürze

Cuir Leather Leder

PRO
045217 **33,95 € HT**

ÉQUIPEMENTS POUR OPÉRATIONS SUR VÉHICULES ÉLECTRIQUES & HYBRIDES - Equipment for operations on electric and hybrid vehicles - Ausrüstung für den Betrieb von Elektro- und Hybridfahrzeugen

ÉCRAN FACIAL AVEC SERRE-TÊTE
- FACE SHIELD WITH HEADBAND
068018

NEW

GANTS ISOLANTS (T10)
- INSULATING GLOVES (T10)
068025

NEW

Coffret de 25 outils isolés 1000V - 25 pieces insulated tools 1000V - Box mit 25 isolierten Werkzeugen 1000V
066489 **391,0 € HT**

Douilles 7/8/10/12/14/15/17/19/22 mm - 7/8/10/12/14/15/17/19/22 mm sockets	x 9
Pince universelle de 175 mm en chrome vanadium - 175 mm universal pliers in chrome vanadium	x 1
Pince coupante 150 mm en chrome vanadium - Cutting pliers 150 mm in chrome vanadium	x 1
Cluqiet en 3/8" - 3/8" ratchet	x 1
Rallonge 100 mm - Extension 100 mm	x 1
Poignée en T - T-handle	x 1
Clés plates à fourches 7/8/10/12/14/17 mm - Open ended wrenches 7/8/10/12/14/17 mm	x 6
Couteau pour câble - Cable knife	x 1
Tournevis Philips PhH1x100/PhH2x100 mm - Phillips PhH1x100/PhH2x100 mm screwdriver	x 2
Tournevis plats 5,5x125/4x100 mm - Flat screwdriver 5.5x125/4x100 mm	x 2

Kit pour le balisage de la zone d'intervention
- Kit for marking the area of intervention - Kennzeichnungsset für Hochvolt-Bereiche
064409 **1 051,0 € HT**

Balise de signalisation rouge et blanche - Red and white warning pole	x 4
Chaîne de délimitation rouge et blanche - Red and white bounding line	x 1
Pancarte de signalisation "Danger, zone de travail VEH" - Sign board "Danger, working area EHV"	x 2

PANTALON - Trousers - Hose

98% cotton, 2% antistatic

EN ISO 11611 Class 2-A1 & A2

EN ISO 11612 A1+A2-B1-C1-E3-F1

IEC 61482-2 Class 1-4kA

EN 1149-5

EN 14404 +A1 Type 2

S (40/42)
046368 **87,95 € HT**

M (44/46)
046375 **87,95 € HT**

L (48/50)
046382 **87,95 € HT**

XL (52/54)
046399 **87,95 € HT**

XXL (56/58)
046412 **87,95 € HT**

VESTE - Jacket - Jacke

98% cotton, 2% antistatic

EN ISO 11612 A1+A2-B1-C1-E3-F1

EN ISO 11611 Class 2-A1 & A2

EN 1149-5

EN 14404 +A1 Type 2

S (40/42)
046313 **98,95 € HT**

M (44/46)
046320 **98,95 € HT**

L (48/50)
046337 **98,95 € HT**

XL (52/54)
046344 **98,95 € HT**

XXL (56/58)
046351 **98,95 € HT**

BSU & CHARGERS

BATTERY SUPPORT UNIT

Homologations Approvals Zulassungen TESLA APPROVED EQUIPMENT

A FULL RANGE FOR ALL NEEDS



NEW

CATALOGUE 2021

Chargers, Boosters & Starters

CHARGERS
6 - 12 - 24 - 36 - 48 V

STARTERS & CHARGERS
12 - 24 V

BOOSTERS
6 - 12 - 24 V

TESTERS
12 - 24 V

ACCESSORIES
+
MORE



A COMPLETE RANGE

for 200 > 240 V MONO / TRI
50/60 Hz

DÉBOSSÉLAGE - Dent pulling - デントプラー

GYSPT 2600 page 6	2700	39.02 page 7	PRO 230	EXPERT 200	EXPERT 230	ALU PRO FV page 8	COMBI 230 PRO page 9	ARC PULL 200 page 12	ARC PULL 350
----------------------	------	-----------------	---------	------------	------------	----------------------	-------------------------	-------------------------	--------------

SOUDURE PAR POINT - Spotwelding - スポット溶接

GYSPT B.P.LCX-s7 220 V page 44	PTI 220 V page 45	B.P.LG 220 V page 48	PTLG 220 V page 50
-----------------------------------	----------------------	-------------------------	-----------------------

RIVETAGE - Riveting - リベット打ち

GYSPRESS 10T page 54	8T PP	10T PP	GYSPRESS 10T PP CONTROL page 56
-------------------------	-------	--------	------------------------------------

MIG/MAG TRADITIONNEL - Traditional MIG/MAG - ミグマグトラディショナル

M1GYS AUTO page 64	M3GYS AUTO page 64	T1GYS AUTO DV page 65	T3GYS AUTO DV page 65
-----------------------	-----------------------	--------------------------	--------------------------

MIG/MAG INVERTER PULSÉ - ミグマグパルスインバーター

AUTOPULSE 220-M1 page 69	AUTOPULSE 220-M3 (208-240V) page 69	AUTOPULSE 320-T3 (208-240V) page 70
-----------------------------	----------------------------------------	----------------------------------------

CHARGEUR - Battery charger - バッテリーチャージャー

GYSFLASH 50.12 FV

DÉCOUPAGE PLASMA - Plasma cutting - プラズマカッター

EASYCUT 40
CUTTER 30 FV
CUTTER 45 CT page 84

INDUCTION - インダクション

GYSDUCTION AUTO page 78	COMBIINDUCTION	POWERDUCTION 37LG page 80	39LG	50LG	110LG	160LG
----------------------------	----------------	------------------------------	------	------	-------	-------



INDIAN CAR MANUFACTURER APPROVALS / COMPLIANCE

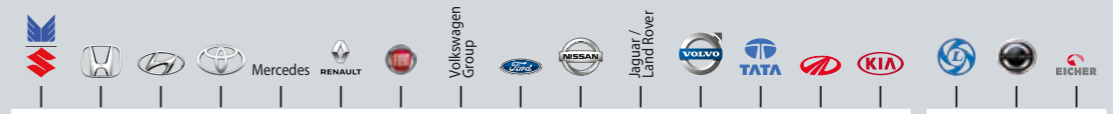

		OEM - CARS										OEM - TRUCKS					
DENT PULLER	GYSPT 39.02																
	SPEEDLINER																
SPOT WELDERS	GYSPT ALU FV																
	GYSPT 32D																
	GYSPT INVERTER BP-MS/LX/LC/LQC																
MIG/MAG	GYSPT EVOLUTION PTI-s7																
	CARMIG																
	T1 GYS AUTO																
PLASMA	T3 GYS AUTO																
	NEOPULSE																
INDUCTION	CUTTER 25K																
	CUTTER 30FV																
BATTERY CHARGERS	GYSDUCTION AUTO																
TOOLS & TROLLEYS																	

INDIAN HOMOLOGATIONS

200 - 208 - 230 - 240 V TRI - 50/60 Hz